

Articles

Cat. No

Description



Amos® White Craft Glue, High Quality Liquid Glue, Washable, Odorless, 36 · 74 · 120g NEW
 Ideal for Wood · Fabric · Craft Paper, Dry Clear, 목공용 접착제

■ 다양한 용도 ; 다양한 범위에서 사용 가능한 접착제

- * Broad Precise Application * Apply to Clean & Dry Surfaces
- * Two-way Tips : Wide for Large Areas & Narrow for Precise Application

<B4>

- A5.1007** Adhesive, White Craft Glue, 36g
- A5.1008** , 74g
- A5.1009** , 120g

Ea.	Price, ₩	Cs.	Price, ₩
	620	10ea	
	1,120	10ea	
	1,740	10ea	



(1) 2g "AD122" (2) 4g "AD124-G"

3M® Scotch® 2g · 4g · 7g · 20g Quick dry Super Glue-gel, in Safety Vessel
 Good for Small Gaps, for Ceramic · Glass · Leather · Metal · Rubber · Wood, 강력 순간접착제

- * Solvent-Free, No-Tips. * Cyano Acryl Resin Based.
- * Quick drying Super Strength Adhesive Designed for a Wide Variety of Surfaces.

<B4>

(1) 2g "AD122" Super Glue Gel, with Safety Vessel, 초강력 타입

3M.02.1009 Scotch® "AD122" Super Glue-gel, 2g

Pk.	Price, ₩	Cs.	Price, ₩
1ea	2,420	12pk	

(2) 4g "AD124-G" Super Glue Gel, Clog-resistant, 막힘방지 타입 NEW

3M.02.1026 Scotch® "AD124-G" Super Glue-gel, 4g

Pk.	Price, ₩	Cs.	Price, ₩
1ea	4,150	12pk	

(3) 7g "AD127" Brush-type Super Glue-Liquid, with Safety Vessel, 브러쉬 타입

3M.02.1011 Scotch® "AD127" Brush type Super Glue Liquid, 7g

Pk.	Price, ₩	Cs.	Price, ₩
1ea	2,360	10pk	

(4) 20g "AD120" Twist Cap type Super Glue-Liquid, 트위스트캡 타입

* Not Blacked Hole, Adjustable Volume.

3M.02.1012 Scotch® "AD120" Twist Cap type Super Glue Liquid, 20g

Pk.	Price, ₩	Cs.	Price, ₩
1ea	3,040	12pk	



(3) 7g "AD127" (4) 20g "AD120"



(1) 다용도 (2) 목공용 (3) 석재용

AXIA® 50g Quickdry Instant Adhesives, Low Viscosity, -54℃ +82℃, 다용도 강력 순간접착제 NEW

■ Made in Korea

(1) 50g "011F" Adhesives, 다목적, 초속경화

DH.Adh3005 Instant Adhesives, "011F", Multiuse, 50g

<B3>

Ea.	Price, ₩	Pk.	Price, ₩
	4,940	20ea	

(2) 50g "835G" Adhesives, 목공용, 속경화

DH.Adh3006 Instant Adhesives, "835G", Multiuse, 50g

Ea.	Price, ₩	Pk.	Price, ₩
	4,040	20ea	

(3) 50g "911G" Adhesives, 인조대리석용, 초속경화

DH.Adh3007 Instant Adhesives, "911G", for Artificial marble, 50g

Ea.	Price, ₩	Pk.	Price, ₩
	4,030	20ea	

NEW



3M® “99” Hi-Strength Spray Adhesive, Strong Adhesion, Heat Resistance 80°C, 300 & 478g NEW
 Excellent Initial Adhesion, Even Coverage, “99” 고강도 스프레이 접착제

- 고강도, 고내열성, 초기 접착력 우수
- 다양한 재질을 깨끗하고 강하게 접착시키며 간편하게 뿌려 사용
- 목재용 라미네이팅 필름, PP와 PE를 포함한 플라스틱 면 접착 시 용이함
- * Strong Adhesion to Various Surfaces : Laminating Film, Light Wood, Plastic, Metal Panel
- * Even Coverage with Minute Particle Type Spray
- * Prevent Degeneration and Discoloration without Permeating the Adhesive Surface

3M.08.1001 (1) Adhesive, 99 Spray, High Strength, 300g
3M.08.1002 (2) , 478g

Ea. Price, ₩	Cs.	Price, ₩
7,590	30ea	
8,380	12ea	

<B4>

NEW



3M® Super Fast Plastic Repair Urethane Adhesive, Dual-Syringe Cartridge System, 200ml NEW
 Ideal for Replacing & Repairing Plastic Parts, Excellent Gap-filling, 200ml 슈퍼 패스트 플라스틱 다목적 우레탄 접착제

- 2액형 우레탄 타입의 플라스틱 기판을 위한 다목적 접착제
- 매우 빠른 경화속도(20초)
- 큰 단차를 매우 쉽게 매꿀 수 있는 작업성과 유연성
- 경화 후 원래 부품보다 더 단단함, 쉬운 가공성 및 성형성
- * Excellent Gap-filling Capabilities
- * Clear Color
- * Bond Created in 60 Seconds
- * Quick Drying (20 Seconds)

3M.08.PN4247 Adhesive, “04247”, Urethane, Plastic Repair, 200ml

Ea. Price, ₩	Cs.	Price, ₩
33,760	30ea	

<B4>

NEW



3M® “1099” Nitrile High Performance Plastic Adhesive, Long Lasting Adhesion, 148ml NEW
 Strong Bonds on Most Vinyls and Plastics, Quick Drying, 니트릴 고성능 플라스틱 접착제

- 대부분의 비닐 및 플라스틱 접착 가능한 접착제; 강력하고 빠르게 건조
- 내마모성, 내수성 및 내연료성을 가지며 가소제 이행 방지
- * Resists Weathering, Water, Oil, Plasticizer Migration and Fuels
- * Provides Strong, Quick Drying Flexible Bonds
- * Optional Heat Cure Increases Bond Strength

3M.08.1099 Adhesive, “1099”, for Plastic, 148ml

Ea. Price, ₩	Cs.	Price, ₩
10,000	12ea	

<B4>

NEW



AXIA® Thread Locking Adhesives, for Metal Thread, 50 & 250ml NEW
 Medium & High Viscosity, -60°C + 150°C, 나사고정제, 중·고강도

- Made in Korea
- 볼트, 너트, 나사 등의 고정용도
- * 경화속도 : “2420” 3~15분, “2770” 20~60분
- * 완전경화 : 24시간

DH.Adh3010 (1) Adhesives, “2420”, Blue, Medium Viscosity, 50ml
DH.Adh3011 , 250ml
DH.Adh3012 (2) Adhesives, “2770”, Red, High Viscosity, 50ml
DH.Adh3013 , 250ml

Ea. Price, ₩	Pk.	Price, ₩
7,840	10ea	
27,650	18ea	
7,840	10ea	
27,650	18ea	

<B3>

NEW



Adhesive Promoter, Spray-type, 230ml NEW
 경화 촉진제

- * 접착속도 단축
- * 백화현상 방지

Ea. Price, ₩	Pk.	Price, ₩
13,720	20ea	

<B3>

DH.Adh3016 Adhesive Promoter, “802G”, Spray-type, 230ml

Epoxy Adhesive Set, Excellent Resistance of wear / shock / Chemicals NEW
 에폭시 강력 접착제 세트



- Made in Korea
- * 구성품 : Hardener 1EA, Resin 1EA
- * 혼합 1 : 1 로 사용이 편리
- * 경화 후 체적 수축 없음
- * 방수효과가 크며 인화성 없음

DH.Adh3018 Epoxy Adhesive, “EP30G”, 250g | 26,960 | 10ea

Ea. Price, ₩	Pk.	Price, ₩
26,960	10ea	

<B3>

LOCTITE 축열부 고정제, Retaining Compound 다국적

NEW



(1) 609 (2) 638 (3) 648

- | | | |
|--------------------|--------------------|--------------------|
| (1) “609” | (2) “638” | (3) “648” |
| ■ 압입부위용 | ■ 고강도, 속경화 | ■ 고강도, 속경화 |
| ■ 사용온도 : -54~150°C | ■ 사용온도 : -54~150°C | ■ 사용온도 : -54~177°C |
| ■ 경화속도 : 10분 | ■ 경화속도 : 5분 | ■ 경화속도 : 5분 |
| ■ 완전경화 : 24시간 | ■ 완전경화 : 24시간 | ■ 완전경화 : 24시간 |

<B3>

ORDER NO.	MODEL NO.	PRICE, ₩ Ea.	강도	용량(ml)	포장단위 Ea. / Cs.
(1) 0300-426	609	16,960	중강도	50	1 / 10
0303-307		60,470		250	
(2) 0298-984	638	74,000	고강도	250	
(3) 0298-986	648	89,870			

Articles Cat. No Description

NEW  **WX890**

WORX INNOVATION **충전 글루건, 4V Cordless Glue Gun** 다국적 **4V**

주 문 번 호 0585-917 가 열 시 간 15초
 전 압 4V 글 루 스 틱 7mm
 중 량 0.3kg 접 착 온 도 160도
 배 터 리 2.0Ah(내장형) 액 세 서 리 6pcs
 총 전 타 입 C타입 정 가 47,040

<B3>

EXSO **핫멜트 글루건, Hot Melt Glue Gun** KOREA

NEW 

(1) & (2) 20&40W (3) 온도조절형, 60W

<B3>

ORDER NO.	MODEL NO.	PRICE, ₩ Ea.	글루스틱(φ)	규격	포장단위 Ea. / Pk.
(1) 0292-403	GR-20	7,250	7.3	220V, 20W	1 / 10
(2) 0240-435	GR-60	16,180	11.3	220V, 40W	1 / 5
(3) 0297-834	GR-560	34,310	11.3	220V, 60W (온도조절형)	1 / 5

EXSO **핫멜트 글루 스틱(백색), Hot Melt Glue Stick, White** KOREA

NEW 

<B3>

ORDER NO.	PRICE, ₩ Pk.	규격(φ)	포장단위 Pk. / Cs.
0240-436	2,220	7.3	10ea / 60pk
0298-026	2,220	11.3	5ea / 60pk
0298-027	9,910	11.3	1kg / 10pk

NEW 

3M® Premium Multiuse Adhesive Remover-Cleaner, Strong Cleaning Efficiency, 295g **NEW**
 Excellent for Removal of Adhesive Residue, **다용도 접착제 제거제, 프리미엄 타입**

- 천연 오일 성분을 함유한 강력 크리너, 탁월한 세정력과 세척력
- * Made of Natural Citrus Oil Based * Removing without Damaging the Surface
- * Wipes Away with Water after Use * Suitable for Adhesive Resid, Grease, Tar, Oil, Old Stains, and etc.
- * It Clean without Streaking and Has Proven to be Excellent for Cleaning a wide Variety of Industrial Materials

<B4>

Pk.	Price, ₩	Cs.	Price, ₩
1ea	5,320	12pk	

3M.08.1003 Premium Multiuse Adhesive Remover, 295g

NEW 

NABAKEM **스티커 접착 제거제, Sticker(Glue) Remover Spray** KOREA

- 무자극 크리너
- 금속, 플라스틱, 고무, 페인트에 안전
- 세척과 광택의 이중효과
- RoHS(6대 유해물질) 검출안됨

<B3>

ORDER NO.	MODEL NO.	PRICE, ₩ Ea.	용량(ml)	포장단위 Ea. / Cs.
0470-602	SSR-450	5,080	450	1 / 20

NR **다목적 실리콘 실란트** KOREA

Neutral Silicone Sealant

- 내구성, 내후성이 우수
- -25℃~150℃에서도 뛰어난 유연성
- 무초산으로 냄새가 적음
- 각종 건축자재에 우수한 접착력
- 유리 글레이징 전용(복층유리 사용금지)
- 알루미늄 및 PVC 창호의 실링 (AL+유리, PVC+유리)
- 컨테이너 및 조립식 건물 조인트

NEW 

<B3>

ORDER NO.	MODEL NO.	색상	PRICE, ₩ Ea.	용량(ml)	포장단위 Ea. / Cs.
0470-729	N2000	○ 백색	2,040	270	1 / 25
0470-730		● 회색			
0470-732		● 흑색			
0523-459		● 적색	2,290	270	1 / 25
0470-733		○ 투명	2,290	270	1 / 25
0523-455		○ 반투명	2,380	270	1 / 25
0523-453		● 금색	2,380	270	1 / 25

NURI **바이오 실리콘 실란트** KOREA 

Sanitary Silicone Sealant

- 항균제로 뛰어난 방균효과 발휘
- 욕실, 주방 자재에 우수한 접착력
- 우수한 내열, 내한, 내후성
- 욕실, 싱크대 주위 습기가 많은 곳
- 병원, 식품공장, 제약공장 등 방균이 필요한 곳



NURI **외장용 실리콘 실란트** KOREA 

Acrylic Silicone Sealant

- 대부분의 건축자재에 대한 비오염성
- 우수한 내열·내한·내후성
- 내·외장 석재 조인트 및 창호주위 실링
- 알루미늄 복합 패널, 법랑 패널 조인트
- 유리 글레이징 (AL+유리)



<B3>

ORDER NO.	MODEL NO.	색상	PRICE, ₩ Ea.	용량(ml)	포장단위 Ea. / Cs.
0470-734	S2000	○ 백색	3,730	270	1 / 25
0501-397		○ 투명			

<B3>

ORDER NO.	MODEL NO.	색상	PRICE, ₩ Ea.	용량(ml)	포장단위 Ea. / Cs.
0523-475	WS2000	○ 백색	3,900	270	1 / 25
0523-476		○ 투명			
0523-477		● 회색			

NURI **내열 실리콘 실란트** KOREA 

Heat-Resistance Silicone Sealant

- 50℃~260℃의 지속적인 노출에도 내열성 유지
- 최대 300℃ 노출에도 성능 유지
- 우수한 방수, 방습, 방음, 방진 효과
- 보일러, 히터, 산업용 오븐, 무빙오븐벨트 등 실링
- 자동차 선박의 엔진룸, 연통주위 실링
- 고온에서 작동하는 부품류 실링



NURI **클린룸용 실리콘 실란트** KOREA 

Silicone for Clean Room

- 폭 넓은 부위에 작업 용이
- 우수한 내열, 내한, 내후성
- 질소 산화물 및 휘발성 실록산 최소화
- 클린룸 실링, VOC에 민감한 현장, 건축 내·외장 조인트



<B3>

ORDER NO.	MODEL NO.	색상	PRICE, ₩ Ea.	용량(ml)	포장단위 Ea. / Cs.
0523-449	HR2000	● 적색	4,570	270	1 / 25
0523-450		● 회색			

<B3>

ORDER NO.	MODEL NO.	색상	PRICE, ₩ Ea.	용량(ml)	포장단위 Ea. / Cs.
0523-480	CR2000	○ 백색	4,740	270	1 / 25
0523-481		● 회색			

NURI **실리콘 실란트 건, Silicone Sealant Gun** KOREA 

(1) 일반형 (2) 카타건타입

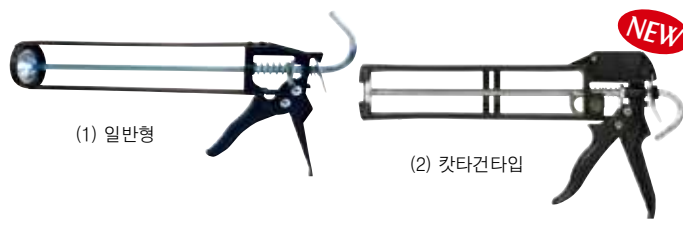

<B3>

ORDER NO.	MODEL NO.	PRICE, ₩ Ea.	포장단위 Ea. / Cs.
(1) 0500-926	일반형	3,060	1 / 24
(2) 0314-432	카타건	5,410	1 / 30

SUNKEY **실리콘 스크래퍼, Silicone Trowel & Scraper** TAIWAN 

(1) 일반용 (2) 다용도용

전방 실리콘 제거 후방 실리콘 제거 표면 처리 날

패드&날 변형 전·후방 실리콘 제거 다양한 패드로 맞춤 마감처리 표면 처리 날



<B3>

ORDER NO.	MODEL NO.	PRICE, ₩ Ea.	포장단위 Ea. / Cs.
0517-131	SSS-01	5,290	1 / 24
0517-132	SSS-02S	9,290	1 / 12

※ Note! Urethane Foams & Guns 우레탄 폼 & 건 ⇒ See the “Tools, Urethane Foams & Guns” Section !

Articles	Cat. No	Description
----------	---------	-------------



NEW

LDPE Disposable Apron, Good for Fluidproof of Chemical · Water, -50°C +80/90°C stable, L95cm
 Ideal for Home, Food, Industry and Laboratory, Harmless, Non-toxic, **일회용 다용도 비닐앞치마** NEW

- 비닐로 만들어 외부 오염물질로부터 오염을 방지할 수 있어 매우 위생적이며 작업장, 식당, 실험실 등 다양한 곳에 적합
- * Ideal for Home, Industry and Laboratory &c. where Fluidproof of Chemical · Water is required.
- * Made of LDPE Material * -50°C +80/90°C stable

<B1>

Pk.	Price, ₩
3ea	2,040

DH.Apr3010 Apron, LDPE, Disposable, 70×L95cm, 3pcs



NEW

- Blue
- Black
- Khaki

PVC Waterproof Apron, Light and Long-term Wearable, w72×L97cm, Free-size NEW
 Ideal for Laboratory · Industry · Chemical · Food and Cleaning, **작업용 방수 앞치마, 고급 PVC**

- 고급 PVC 방수재질로 실험실, 작업실, 청소, 음식 등에 적합함
- * Made of PVC Material * Ideal for Laboratory, Industry, Chemical, Food and Cleaning
- * Convenient, Waterproof

<B1>

Ea.	Price, ₩
	5,100
	5,100
	5,100

DH.Apr3011 Apron, Waterproof, PVC, w72×L97cm, Blue
DH.Apr3012 , Black
DH.Apr3013 , Khaki



NEW

Chemical Resist

3M® “Microchem® 3000” Chemical Resistant Apron, Made of Polypropylene NEW
 Durable & Wearable, KOSHA Certified, **내화학 앞치마, 유기화합물용**

- 한국산업안전보건공단 유기화합물용 보호복 인증 획득 상품, 광범위한 케미칼에 대한 보호도 제공
- KOSHA(Korea Occupational Safety and Health Agency) Certified
- * Excellent Resistance to a Wide Range of Chemicals

<B4>

Ea.	Price, ₩
	5,320

3M.MC3000 Apron, Chemical Resistant, Yellow, Free-size



NEW

55cm

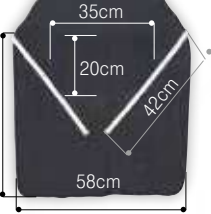

NEW

90cm



▶ 중형

용접 앞치마 Welding Apparel, 재질: (1) Denim(청면포), (2) Cowhide(소가죽) NEW
 다국적

(1) 데님(두꺼운 면포) 앞치마 Denim Apron

- * 마찰에 강하고 직/간접적인 불꽃에 의한 화상 방지
- * 앞주머니가 있어 간단한 작업도구 수납 가능

<B3>

Ea.	Price, ₩	Pk.	Price, ₩
0460-484	Denim Apron “KDA-550X”, 58×h90cm	1,830	10ea

(2) 통가죽 앞치마 Cowhide Apron

- * 앞치마 형태로 활동성이 좋으며 통가죽 처리됨

Ea.	Price, ₩	Pk.	Price, ₩
0361-608	Cowhide Apron, 60×h90cm	6,770	5ea

, Arm Covers 팔토시



NEW

Black

- Blue
- Khaki

PVC Waterproof Arm Cover, Free Size, Multi-use, Length 330mm NEW

Non-slip down with Rubber Band, Light, **작업용 방수 팔토시, 고급 PVC**

- 고급 PVC재질로 가벼워 장시간 착용에도 피로감이 없고, 방수재질로 실험실, 작업실, 청소, 음식 등에 적합함
- * Made of PVC Material * Light and Long-term Wearable
- * Ideal for Laboratory, Industry, Chemical, Food and Cleaning

<B1>

Pair.	Price, ₩
DH.App3031	Arm Cover, Waterproof, PVC, w170×L330mm, Blue
DH.App3032	, Black
DH.App3033	, Khaki
	2,040
	2,040
	2,040

DH.App3031 Arm Cover, Waterproof, PVC, w170×L330mm, Blue
DH.App3032 , Black
DH.App3033 , Khaki



NEW

General Purpose Arm Covers

ORUN™ Cotton/PE Arm Covers, General Purpose, Free Size, L390mm NEW

Ideal for Dust and Contaminants Protection, **작업용 다용도팔토시**

- 피부나 옷이 오염되는 것을 방지하며 사무실, 학교, 실험실 및 작업장 등에서 사용에 적합
- * Made of Mixed-Cotton & -Polyester * Color will be Delivered Randomly

<B3>

Pk.	Price, ₩	Cs.	Price, ₩
SL.App3032	Arm Cover, Free-size, L390mm, 4pcs.	1pair	1,930
		500pk	932,140

3M® "Pro-Sleeve2000" Cooling Arm Cover, Made of AQUA-X Fiber, Free Size, L390~400mm **NEW**

Ideal for Outdoor and Industry, High Absorbency, High UV Protection, Reusable, 자외선 차단용 쿨토시, 일반형 & 손등보호형



- AQUA-X원사 사용으로 최상의 착용감과 통기성이 뛰어남
- * Offers High UV Protection and High Absorbency
- * Excellent for Variety of Outdoors Activities
- * With Quick Drying and Wind Resistance Features
- * Best Fitting Condition Thanks to Ergonomic Design

(1) Standard Sleeve Arm Cover, 일반형

3M.PS2000.B "PS 2000" Arm Cover, Standard-type, Black
3M.PS2000.G , Light Gray
3M.PS2000.W , White

<B4>			
Pair.	Price, ₩	Cs.	Price, ₩
	3,840	100pair	354,200
	3,840	100pair	354,200
	3,840	100pair	354,200



(2) Protective Hands Arm Cover, 손등보호형

3M.PS2000H.G "PS 2000H" Arm Cover, Protective Hands-type, Light Gray
3M.PS2000H.W , White

Pair.	Price, ₩	Cs.	Price, ₩
	4,530	100pair	418,600
	4,530	100pair	418,600

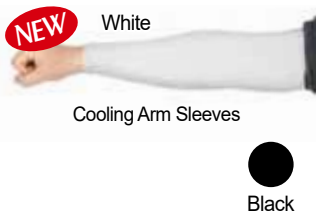

ORUN™ Cooling Arm Cover, UVA & UVB 99.9% Protection, Sweat Absorbent, L360mm **NEW**

Ideal for Outdoor, Laboratory and Industry, <Korea-made>, 자외선차단 쿨토시

- KATRI(한국의류시험연구원) 아릴아민&폴알데하이드 테스트 통과
- 압박감이 없고 흘러내림이 없어 부드러운 착용 감으로 야외 활동, 실험실 및 작업실 등에 사용에 적합
- * Made of Polyurethan & Polyamid * 2 Color will be Delivered Randomly (Black, White)
- * Comfortable and Flexible

SL.App3031 Arm Cover, Cooling, Free Size, L360mm

<B3>			
Pk.	Price, ₩	Cs.	Price, ₩
1pair	1,930	500pk	932,140



용접 토시, Welding-Wristlet

다국적

- * 화기, 베임 및 마찰등의 산업적인 위험요소로부터 팔을 보호

0362-109 용접 장토시, 어깨끈부착형, Pair

<B3>			
Ea.	Price, ₩	Pk.	Price, ₩
	6,660	10ea	



정전기 방지기 (손목밴드), Antistatic Wrist Band

KOREA

<B3>

ORDER NO.	MODEL NO.	PRICE, ₩ Ea.	포장단위 Ea. / Pk.
0481-513	EX-611B	3,770	1 / 15

, Caps/Hood 캡/두건



Polyester Cap for Clean Room, Class 1000, 크린룸용 방진모, 정전기 방지 **NEW**

- Made of Polyester * Anti-electrostatic. Conductive Filament Yarn Piece
- * Dyed 100% Polyester. * Good for Over 1000 Class Clean Room & Laboratory
- * 1000 Class(NHB5340.2) : 0.5µm Particles Under 1,000Ea. / 1ft³

DH.Cap3301 (1) Cap, Men Basic-type
DH.Cap3302 (2) , Women Basic-type

<L1>	
Ea.	Price, ₩
	3,940
	3,940



Polyester & Carbon Clean Room Hair Cap, Disposable, Class 1000, 크린룸 일회용 캡, 정전기 방지 **NEW**

- Made of Dyed 100% Polyester & Carbon
- * Anti-electrostatic. Conductive Filament Yarn Piece
- * Good Fit and Comfort, Using a Soft Band
- * 1000 Class(NHB5340.2) : 0.5µm Particles Under 1,000Ea. / 1ft³

DH.Cap3306 Hair Cap, Disposable

<L1>			
Pk.	Price, ₩	Cs.	Price, ₩
100ea	8,330	20pk	154,050

Articles

Cat. No

Description



Buffalo® 멀티 두건(바라크라바), 이중원단, Multipurpose Hood **NEW**

- 각종 야외활동 및 겨울 스포츠용으로 사용
- 이중 원단으로 뛰어난 보온성과 부드러운 착용감

- 청음이 가능한 방한용 마스크

BFL.211 Multipurpose Hood, Free-size

Ea.	Price, ₩	Cs.	Price, ₩
	7,560	100ea	700,000



용접 두건, Welding-Hood 다국적

* 용접 작업시 머리에 착용하는 머리 및 어깨 보호용 두건

0405-157 용접두건, 사계절용

Ea.	Price, ₩
	3,170



Buffalo® 이어캡, 이중원단, Earmuffs **NEW**

- 각종 야외활동 및 겨울 스포츠용으로 사용
- 이중 원단으로 뛰어난 보온성과 부드러운 착용감

- 청음이 가능한 방한용 이어캡
- Color : 블랙

BFL.205 Winter Earmuffs, Free-size

Ea.	Price, ₩	Cs.	Price, ₩
	3,030	100ea	280,000



3M® "Pro Neck Light" Cooling Neck Cover, Multipurpose Scarf, UV Protection, Lightweight **NEW**

Ideal for Skin Protection, Excellent for Sweat Absorption, Seamless, Quick Drying, 쿨 스카프

- 뛰어난 신축성과 가벼움으로 최적의 착용감, 강력한 자외선 차단력
- Made of Aerosilver & Aerocool Fabric

- Suitable for Industry, Outdoor, and Sports Activity
- * Sweat Absorption & Fast Dry

- * Best Fit with Excellent Elasticity & Lightness
- * Excellent UV Protection

3M.PN1000L.BLU Neck Cover, Cooling, Blue

3M.PN1000L.GRA , Light Gray

Ea.	Price, ₩	Cs.	Price, ₩
	12,180	100ea	1,127,000
	12,180	100ea	1,127,000



3M® Neck Guard for 4-Seasons, Ear-loop Type, Breathable, Free Size **NEW**

Ideal for Outdoor and Industry, High UV Protection, Anti Bacterial, Excellent Elasticity, 빅가드, 사계절용

- NILIT® Fiber 원단으로 부드러운 착용감 및 편안한 호흡 가능
- 귀걸이형 타입으로 흘러내림 방지

- * High UV Protection & Dust Protection
- * Excellent for Variety of Outdoor Activities

- * Ear-loop Type, To Prevent Slipping Down
- * Seamless & Wearable

3M.PN1000F.LG (1) Neck Guard, for 4 Seasons, Free Size, Light Gray

3M.PN1000F.RED (2) , Red

Ea.	Price, ₩	Cs.	Price, ₩
	10,970	100ea	1,014,310
	10,970	100ea	1,014,310



Buffalo® 빅워머, 이중원단, Neck Warmer **NEW**

- 각종 겨울 스포츠 및 야외 활동용으로 사용
- 이중 원단으로 내피의 보온성이 뛰어나며 착용감이 부드러움

- Color : 다크네이비
- 270mm×240mm

BFL.201 Neck Warmer, Free-size

Ea.	Price, ₩	Cs.	Price, ₩
	6,050	100ea	560,000



Buffalo® 멀티 스카프, 상하좌우의 신축성, Multipurpose Scarf **NEW**

- 스카프, 머리띠, 마스크, 손목밴드, 두건 등 다양하게 변형 활용 가능

- 뛰어난 차단력으로 피부보호, 상하좌우 놀라운 신축성
- 선명도가 뛰어난 카모플라주 프린팅

- Color : 네이비, 레드
- 250mm×500mm

BFL.216 Multipurpose Scarf, Free-size, Navy

BFL.217 , Red

Ea.	Price, ₩	Cs.	Price, ₩
	3,030	100ea	280,000
	3,030	100ea	280,000

Articles

Cat. No

Description



용접 각반, Welding-Leg-guard

다국적

* 광폭 벨크로 사용으로 사이즈 조절

0460-485 용접각반 "KWG-230X" 사계절용, Pair

<B3>

Ea.	Price, ₩
	4,470



Antistatic Polyester & Carbon Clean Room Shoe Cover

Clean Class 10,000, 크린룸/정전기 방지 신발 커버

■ 정전기 방지 ■ 단층구조 장섬유 부직포로 제조되어 작업자의 공정보호에 효과적 ■ 분진 및 소량의 액상물질 방어에 적합
 * Anti-electrostatic. Conductive Filament Yarn Piece
 * Dyed 100% Polyester & Carbon.

<L1>

DH.App3501 Shoe Cover, for Clean Room

Pk.	Price, ₩	Cs.	Price, ₩
50pair	14,630	10pk	135,460



3M® Disposable Boot-/Shoe- Cover, Type 5 & 6, Durable, Low Linting Fabric

Anti-static, Lightweight, Universal size, White, 일회용 정전기 방지 신발/부츠 커버

■ 내구성 및 보호도가 우수

* Type 5 - Particle Protection / Type 6 - Limited Liquid Splash Protection
 * Ideal for Protection Particles & Chemical Liquids * Easy to ON & Off

(1) Polyethylene Shoe Cover

(1) Polyethylene Shoe Cover

* Fits Securely around the Ankle with Elasticized Band * Anti-static Treated

3M.03.442 Shoe Cover, PE

<B4>

Ea.	Price, ₩
	890



(2) Polyethylene Boot Cover

(2) Polyethylene Boot Cover

* Provide Excellent Protection * Comfortable Fit * Easy to Wear
 * Anti-static treated * Full Coverage

3M.03.440 Boot Cover, PE

Ea.	Price, ₩
	1,340



(3) PVC Non-slip Boot Cover

(3) PVC Non-slip Boot Cover

* Slip Resistant Sole to Help Improve User Safety
 * Good Fit for a Wide Range of Users

3M.03.450 Boot Cover, Microporous Laminate, Non-slip

Ea.	Price, ₩
	2,670

Articles

Cat. No

Description



Polyester & Carbon Clean Room Wear, Class 1000 **NEW**

Ideal for Clean Room, Anti-Static · Dust Free · Germ Free, 클린룸 웨어, 정전기 방지

- * Dyed 100% Polyester & Carbon
- * Good for Clean Room & Laboratory
- * Easy to Put on and Remove
- * Anti-electrostatic. Conductive Filament Yarn Piece
- * 5mm Spacing of Stripe ESD Conductive Thread
- * Comfortable to Work in
- * Basic Color : White

One-Piece type, Exclude Cap & Shoe

■ 상·하의 일체형으로 Particle 발생을 최소화 한 디자인

- * Low Particle & High Filtration
- * 1000 Class(NHB5340.2) : 0.5 μ m Particles Under 1,000Ea. / 1ft³
- * Good for Over 1000 Class Clean Room & Laboratory

(1) One-Piece type, Exclude Hood & Shoe

- DH.Wea3001 Clean Room Wear(O/P), Medium (Height 155~160cm)
- DH.Wea3002 , Large (Height 160~165cm)
- DH.Wea3003 , X-Large (Height 165~170cm)
- DH.Wea3004 , 2X-Large (Height 170~175cm)

<L1>	
Ea.	Price, ₩
	25,220
	25,220
	25,220
	25,220



Two-Piece type, Exclude Cap & Shoe

- 활동성에 중점을 둔 투피스 타입
- * Good for Over 1000 Class Clean Room & Laboratory

(2) Two-Piece type, "Y" Zipper In Front

- DH.Wea3011 Clean Room Wear(T/P), Medium (Height 155~160cm)
- DH.Wea3012 , Large (Height 160~165cm)
- DH.Wea3013 , X-Large (Height 165~170cm)
- DH.Wea3014 , 2X-Large (Height 170~175cm)

Ea.	Price, ₩
	20,410
	20,410
	20,410
	20,410

(3) Two-Piece type, "C" Zipper In Front

- DH.Wea3016 Clean Room Wear(T/P), Medium (Height 155~160cm)
- DH.Wea3017 , Large (Height 160~165cm)
- DH.Wea3018 , X-Large (Height 165~170cm)
- DH.Wea3019 , 2X-Large (Height 170~175cm)

Ea.	Price, ₩
	20,410
	20,410
	20,410
	20,410

(2) Neck : "Y" type (3) Neck : "C" type

Gown only & Shirts only

- * Good for Over 1000 Class Clean Room & Laboratory



(4) "Gown only", "Y" Zipper In Front

- DH.Wea3021 Clean Room Gown, Medium (Height 155~160cm)
- DH.Wea3022 , Large (Height 160~165cm)
- DH.Wea3023 , X-Large (Height 165~170cm)
- DH.Wea3024 , 2X-Large (Height 170~175cm)

Ea.	Price, ₩
	11,920
	11,920
	11,920
	11,920

(5) "Gown only", "C" Zipper In Front

- DH.Wea3026 Clean Room Gown, Medium (Height 155~160cm)
- DH.Wea3027 , Large (Height 160~165cm)
- DH.Wea3028 , X-Large (Height 165~170cm)
- DH.Wea3029 , 2X-Large (Height 170~175cm)

Ea.	Price, ₩
	11,920
	11,920
	11,920
	11,920

(4) Gown Only (5) Shirts Only

(6) "Shirts only"

- DH.Wea3031 Clean Room Shirts, Medium (Height 155~160cm)
- DH.Wea3032 , Large (Height 160~165cm)
- DH.Wea3033 , X-Large (Height 165~170cm)
- DH.Wea3034 , 2X-Large (Height 170~175cm)

Ea.	Price, ₩
	12,640
	12,640
	12,640
	12,640

3M® Premium Multi-Protective Clothing, Protection against Micro-organisms and Virus (EN 14126) and Hazardous Particle **NEW**
 Anti-Static (EN 1149), Hoody-type, Ideal for Medical and Industry, Type 3 & 4 & 5 & 6, **프리미엄 안전 보호복, 방역 · 방진 · 내약품**

Symbol Features

①  액상차단&보호 / Liquid Jet Protection 방향성이 있고 강하게 분사되는 액상 케미칼에 대해 보호가능 <EN 340>	⑤  정전기 방지 / Anti-Static <EN 1149>
②  스프레이 차단 / Liquid Spray Protection 보호복에 고일정도로 분사되는 응축된 액상 케미칼에 대해 보호가능 <EN 340>	⑥  방사능오염 방지 / Protection against Nuclear Particles <EN 1073>
③  분진 차단 / Hazardous Particulate Protection 유해한 분진입자로부터 보호가능 <EN 340>	⑦  항 바이러스 차단&보호 / Protection against Micro-organisms and Virus <EN14126>
④  제한적 스프레이 차단 / Liquid Splash Protection 방향성이 없는 액상케미칼의 분무에 대한 보호가능 <EN 340>	

* Size Guide Line : 1) S - Height 164~170cm, Chest Size 84~92cm, 2) M - Height 170~176cm, Chest Size 82~100cm
 3) L - Height 176~182cm, Chest Size 100~108cm, 4) XL - Height 182~188cm, Chest Size 108~115cm

(1) for Particle & Virus Protection, Microporous Laminated-type, Breathable, "MG 2000"





■ 분진, 바이러스, 정전기, 방사능 오염으로부터 보호

* EN 340 Type 5 : Particle Protection, Type 6 : Limited Liquid Splash Protection

* Microporous Coating for Super Protection and Ventilation

* Double Coating Storm Flap for Dust Protection <B4>

* Elasticated Hood, Waist, Ankles and Wrist for Convenient Safe Wear and Freedom of Movement

							Ea.	Price, ₩
3M.MG2000.S	Apparel, MG2000, One-Piece-Hood, White, S							8,120
3M.MG2000.M	, M							8,120
3M.MG2000.L	, L							8,120
3M.MG2000.XL	, XL							8,120





(2) for Liquid & Particle & Virus Protection, Microporous Laminated type, Breathable, "MG 2500"

■ 액체, 분진, 바이러스, 정전기, 방사능오염으로부터 보호

* EN 340 Type 3 : Liquid Jet Protection, Type 4 : Liquid Spray Protection, Type 5 : Particle Protection

* Microporous Film Coating allows to High Protection and Ventilation

* Storm Flap with Full Sealable Tape for Extra Protection





							Ea.	Price, ₩
3M.MG2500.S	Apparel, MG2500, One-Piece-Hood, White, S							17,790
3M.MG2500.M	, M							17,790
3M.MG2500.L	, L							17,790
3M.MG2500.XL	, XL							17,790

(3) for Chemicals & Particle & Virus Protection, with Double Zipper & Cuff, "MG 2300"

■ 케미칼, 분진, 바이러스, 정전기, 방사능오염으로부터 보호

* EN 340 Type 3 : Liquid Jet Protection, Type 4 : Liquid Spray Protection, Type 5 : Particle Protection

* High Respirators Compatibility * Excellent Barrier against Dry Particles and Certain Limited Liquid Chemical Splash

							Ea.	Price, ₩
3M.MG2300.S	Apparel, MG2300, One-Piece-Hood, Yellow, S							23,800
3M.MG2300.M	, M							23,800
3M.MG2300.L	, L							23,800
3M.MG2300.XL	, XL							23,800

(4) for Chemicals & Particle Virus & Protection, "KOSHA Certified", with Double Zipper & Cuff, "MG 3000"

■ 케미칼, 분진, 바이러스, 정전기, 방사능오염으로부터 보호





■ 술기를 열 접촉 후 테이프 처리하여 최상의 보호도 제공

■ KOSHA (Korea Occupational Safety Health Agency) Certified

* EN 340 Type 3 : Liquid Jet Protection, Type 4 : Liquid Spray Protection, Type 5 : Particle

* Suitable for Chemical Mixing & Handling, Pesticide Spraying, and Tank Cleaning & Maintenance

* Designed to offer a Barrier to Hazardous Particles and Certain Liquid Splashes, Sprays and Jets

							Ea.	Price, ₩
3M.MG3000.S	Apparel, MG3000, One-Piece-Hood, "KOSHA Certified", Yellow, S							29,400
3M.MG3000.M	, M							29,400
3M.MG3000.L	, L							29,400
3M.MG3000.XL	, XL							29,400

(5) for Chemicals & Particle Virus & Protection, with Double Zipper & Cuff, Premium Protection-type, "4570"





■ 케미칼, 분진, 바이러스, 정전기, 방사능오염으로부터 보호

* EN 340 Type 3 : Liquid Jet Protection, Type 4 : Liquid Spray Protection, Type 5 : Particle

* Suitable for Chemical Mixing & Handling, Pesticide Spraying, and Tank Cleaning & Maintenance

* Designed to offer a Barrier to Hazardous Particles and Certain Liquid Splashes, Sprays and Jets

* Perfect Seam Protection with Heat Sealed and Taped.

							Ea.	Price, ₩
3M.4570.S	Apparel, 4570, One-Piece-Hood, Gray, S							20,310
3M.4570.M	, M							20,310
3M.4570.L	, L							20,310
3M.4570.XL	, XL							20,310



(1) MG2000



(2) MG2500



(3) MG2300



(4) MG3000

"KOSHA Certified"



(5) 4570

Articles	Cat. No	Description
----------	---------	-------------

3M® Popular Multi-Protective Clothing, Type 5 & 6, Anti-Static (EN 1149-5), Hoody-type **NEW**
 Protection against Nuclear Particles (EN 1073-2) and Hazardous Particulate (EN ISO 13982-1), 보급형 안전 보호복, 방진·내약품

Symbol Features

① Type5	분진 차단 / Hazardous Particulate Protection 유해한 분진입자로부터 보호가능 <EN 340>	③ 	정전기 방지 / Anti-Static <EN 1149>
② Type6	제한적 스프레이 차단 / Liquid Splash Protection 방향성이 없는 액상케미칼의 분무에 대한 보호가능 <EN 340>	④ 	방사능오염 방지 / Protection against Nuclear Particles <EN 1073>



* Size Guide Line : 1) S - Height 164~170cm, Chest Size 84~92cm, 2) M - Height 170~176cm, Chest Size 82~100cm
 3) L - Height 176~182cm, Chest Size 100~108cm, 4) XL - Height 182~188cm, Chest Size 108~115cm
 * Material : Polypropylene * Anti-Static * Lightweight * Extremely Breathable
 * Designed to offer Cost Effective Protection Against Hazardous Dusts.

(1) "4510" White Color

* Super Low-Linting * Elastic Cuffs, Waist and Ankles for a better fit and Freedom of Movement



		<B4>	
		Ea.	Price, ₩
3M.4510.S	Apparel, 4510, One-Piece-Hood, White, S		5,120
3M.4510.M	, M		5,120
3M.4510.L	, L		5,120
3M.4510.XL	, XL		5,120

(2) "4515" White & Orange Color

* Low-Linting * Robust, highly Breathable



		<B4>	
		Ea.	Price, ₩
3M.4515.S	Apparel, 4515, One-Piece-Hood, White, S		3,580
3M.4515.M	, M		3,580
3M.4515.L	, L		3,580
3M.4515.XL	, XL		3,580
3M.4515.O.S	Apparel, 4515, One-Piece-Hood, Orange, S		3,580
3M.4515.O.M	, M		3,580
3M.4515.O.L	, L		3,580
3M.4515.O.XL	, XL		3,580

(3) "4520" White Color, with Knitted Cuff & Elasticated Waist and Ankles

* for Reduced Heat Stress and Breathable Comfort all day
 * 3-panel Elasticated Hood for Enhanced Compatibility.



		<B4>	
		Ea.	Price, ₩
3M.4520.S	Apparel, 4520, One-Piece-Hood, White, S		4,350
3M.4520.M	, M		4,350
3M.4520.L	, L		4,350
3M.4520.XL	, XL		4,350

(4) "4532+" Blue Color, Ideal for Oil and Organic Solvent, with Knitted Cuff & Elasticated Waist and Ankles

■ 알콜 및 오일성액체에 대한 보호도 제공 * Ideal for the Alcohol and Oil Repellence Treatment

		<B4>	
		Ea.	Price, ₩
3M.4532.S	Apparel, 4532, One-Piece-Hood, Blue, S		6,310
3M.4532.M	, M		6,310
3M.4532.L	, L		6,310
3M.4532.XL	, XL		6,310

용접 자켓 & 바지, Welding Jacket & Pants

다국적

NEW



▲ 사계절용

NEW



(1) 용접자켓 Welding Jacket

- * 팔꿈치 보강 부분 솜처리, 뒷면 통가죽
- * 여름용은 등판이 없음

<B3>

Ea.	Price, ₩	
0363-208	용접자켓, 대형, 4계절용	24,120
0355-613	, 여름용(등판이 없음)	21,560

(2) 용접바지 Welding Pants

Ea.	Price, ₩	
0363-209	용접바지, 대형, 허리 ϕ 98cm	28,430

NEW



(1) Standard type

3M® Scotchlite™ Reflective Safety Vest, Durable, Lightweight, Breathable Mesh, Lime Yellow

NEW

Protect from Safety Accident, 360° of Reflectivity, Comfortable, 반사안전조끼, 통풍 심세 메쉬

- * Made of Solid
- * Lightweight Design for a Comfortable Fit

(1) Standard type, without Pocket & Zipper

- 2차 사고 예방을 위한 차량비치용, 개인안전용
- KC Certified
- * Personal Protective Equipment
- * Wearable, Convenient for Storage

<B4>

3M.03.5130	Safety Vest, Reflective, Standard type	Ea.	Price, ₩	Cs.	Price, ₩
			12,880	50ea	624,680

(2) Premium type, with Pocket & Zipper

- 건축, 토목, 도로상 작업 및 긴급상황, 안전요원등에서 사용되는 전문가용
- ANSI 107 & EN471 & KC Certified KC
- * Ideal for Road Work, Construction, Crossing Guards and More
- * High Quality and Durable

3M.03.5131	Safety Vest, Reflective, Premium type	Ea.	Price, ₩	Cs.	Price, ₩
			15,400	50ea	746,910



(2) Premium type

SM

형광반사 안전 조끼, Fluorescent Safety Vest

KOREA

NEW



▲ 천, SM-401-1



▲ 망사, SM-402

- 신호수 안전 조끼로 반사띠가 부착되어있어 주, 야간 식별 가능
- 뒷면에도 반사띠 부착
- 통풍 원활

<B3>

ORDER NO.	MODEL NO.	PRICE, ₩	규격	재질	포켓
▶ 0437-950	SM-401-1	3,710	XL	천	3개
0437-951			2XL	천	
0437-952			3XL	천	
▶ 0430-068	SM-402	3,710	XL	망사	3개
0430-069			2XL	망사	
0437-953			3XL	망사	

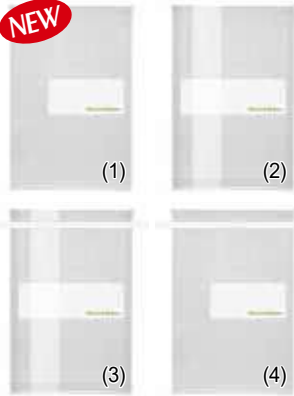
Articles	Cat. No	Description																				
		<p>Green Solution™ PE Sterile Sample Bag, with White Writing Area, 190×h300mm NEW</p> <p>Ideal for Sampling & Stomacher, Plain · Wire · Filter · Filter & Wire-type, PE 멸균 샘플백</p> <ul style="list-style-type: none"> ■ 식품, 환경, 제약 등 다양한 연구분야에서 고체, 액체 시료의 샘플을 운송 및 보관에 사용 * Use for Food Industry, Environmental, Pharmaceutical Sampling * Blending and Filtering Solid and Liquid Samples for Microbiological Analysis * DNase, RNase and Pyrogen Free * Filter is made of Non-woven 																				
		<L2>																				
		<table border="1"> <thead> <tr> <th>Pk.</th> <th>Price, ₩</th> <th>Cs.</th> <th>Price, ₩</th> </tr> </thead> <tbody> <tr> <td>50ea</td> <td>9,480</td> <td>10pk</td> <td>87,730</td> </tr> <tr> <td>50ea</td> <td>17,070</td> <td>10pk</td> <td>157,910</td> </tr> <tr> <td>50ea</td> <td>30,330</td> <td>10pk</td> <td>280,720</td> </tr> <tr> <td>50ea</td> <td>26,540</td> <td>5pk</td> <td>122,820</td> </tr> </tbody> </table>	Pk.	Price, ₩	Cs.	Price, ₩	50ea	9,480	10pk	87,730	50ea	17,070	10pk	157,910	50ea	30,330	10pk	280,720	50ea	26,540	5pk	122,820
Pk.	Price, ₩	Cs.	Price, ₩																			
50ea	9,480	10pk	87,730																			
50ea	17,070	10pk	157,910																			
50ea	30,330	10pk	280,720																			
50ea	26,540	5pk	122,820																			
		<p>DH.Bag3001 (1) Sample Bag, 190×h300mm, 1620ml, Plain type</p> <p>DH.Bag3002 (2) , Filter type</p> <p>DH.Bag3003 (3) , Filter & Wire type</p> <p>DH.Bag3004 (4) , Wire type</p>																				

	<p>Mini Portable Heat Sealer, with Safety Cover, 50g NEW</p> <p>For Various Plastic Films Package, Magnetic-Design for Easy Storage, White, 미니 휴대용 열선 실링기</p> <ul style="list-style-type: none"> ■ 작은 사이즈에 작동이 편리한 가열접합 열선방식 비닐 밀봉기 ■ 바닥 면에 자석이 붙어있어 냉장고에 붙여서 보관 가능 ■ AA건전지 2개 별도구매 <ul style="list-style-type: none"> * Sealer is suited for Various Plastic Films Package * Dust- & Moisture-Proof * Magnet Hidden at the Bottom, which can be adsorbed on the Refrigerator for Easy Storage 	<B1>				
	<p>DH.Pac3001 Mini Portable Heat Sealer, 10×4×2.7cm, 50g</p>	<table border="1"> <thead> <tr> <th>Ea.</th> <th>Price, ₩</th> </tr> </thead> <tbody> <tr> <td></td> <td>15,280</td> </tr> </tbody> </table>	Ea.	Price, ₩		15,280
Ea.	Price, ₩					
	15,280					

Kern® [d] 0.1 & 1g, max.500 & 1,000g Slim Pocket Balance for Reference, with Practical Tare Function, 10×13×h1.8cm, 200g With Large Stainless Steel Weighing Plate & Shock Proof Plastic Cover, Well Protected, 슬림 포켓 디지털 바란스, 간편 영점기능 **NEW**

NEW 2-Year Warranty



Slim Pocket Balance ;
10×13×h1.8cm

- Supplied by Kern® in Germany
- 2-Years Warranty
- CE & ISO 9001 Certified
- High-Resolution Pocket Balance with Particularly Rapid Reaction and Stabilisation Time
- With Particularly Flat Design

- * Shock Proof Plastic Cover as Protection against Pressure and Dust & Can be Used as a Weighing/Tare Cup
- * Stainless Steel Weighing Plate, which Makes Cleaning Easy and Hygienic
- * Weighing Unit : ct, dwt, g, gn, oz, ozt
- * LCD Display : Backlit, Digit Height 12mm
- * Optimal Temperature Range : 0℃~40℃
- * Batteries Included ; 2×CR2032, Operating Time up to 33h

Specifications & Ordering information

<L1>

Cat. No.	Weighing Capacity Max g	Readability d g	Dimensions & Weight (W×D×H, g)	Weighing Plate (Φ)	Price, ₩
KE.TGC500.1S05	500g	0.1g	100×130×18mm, 200g	Φ81mm	38,360
KE.TGC1K.3S05	1,000g	1g			38,360

Shock Proof Plastic Cover



Incl. Shock Proof Plastic Cover
Can be used as a Weighing/Tare Cup

Kern® [d] 0.1 & 1g, max.320 & 1,000g Pocket Balance & Calculator “CM”, 8.5×13×h2.5cm, 180g **NEW**
With Convenient 4-Key Operation & Hard Case Cover, Well Protected, 포켓 바란스 겸 계산기

NEW 2-Year Warranty



Pocket Balance & Calculator “CM” ;
8.5×13×h2.5cm

- Supplied by Kern® in Germany
- 2-Years Warranty
- CE & ISO 9001 Certified
- Highly Portable, Convenient Use due to Combined Balance & Calculator

- * Simple and Convenient 4-Key Operation
- * Robust, Handy, Well Protected
- * LCD Display : Backlit, Digit Height 12mm
- * Batteries Included ; 2×1.5V AAA, Operating Time up to 33h
- * Auto-Off Function to Preserve the Battery
- * Hard Case Cover as Protection against Pressure and Dust
- * Integrated Calculator
- * Optimal Temperature Range : 18℃~25℃

Specifications & Ordering information

<L1>

Cat. No.	Weighing Capacity Max g	Readability d g	Dimensions & Weight (W×D×H, g)	Weighing Plate (W×D)	Price, ₩
KE.CM320.1N	320g	0.1g	85×130×25mm, 180g	70×80mm	106,570
KE.CM1K.1N	1,000g	1g			100,750

Articles

Cat. No

Description

Kern® [d] 10g, max.15kg Ergonomically-Optimised Baby Scale, Ideal for Private **NEW**
 With Auto-off · Feeding · Hold · Memory-Function, Weight Displayed in kg or lb, 인기 보급형 신생아 체중계



2-Year Warranty

NEW

(1) Baby Scale



(2) Optional ; Carrying Case

- Supplied by Kern® in Germany
- 2-Years Warranty
- CE & ISO 9001 Certified
- Using the Scales in Medicine is not Allowed.
- Particularly Flat and Lightweight Construction, So it is Easy to Transport and Store.
- * Large, Ergonomically-Optimised Lying Surface for Safe Weighing of Infants ; 650×350×h55mm
- * Robust Plastic for Easy and Hygienic Cleaning.
- * Integrated AUTO-OFF Function to Preserve Batteries
- * Feeding Function ; Difference Function for Calculating the Weight Gain before and after Feeding
- * Hold Function ; When Patients do not lie completely still, a Stable Weight is Calculated Using an Average Weight
- * With Rubber Feet for Secure & Non-Slip Positioning
- * Batteries included (2×1.5V AAA), Operating Time up to 20h.

Specifications & Ordering information

<M1>

Cat. No.	Weighing Range Max kg	Readability d kg	Dimensions (W×D×H) & Weight	Price, ₩
(1) KE.MBD.20K2S05	15	0.01	650×350×55 mm, 2kg	147,220

Ea.	Price, ₩
	11,630

(2) KE.YTB.01S05 Optional ; Carrying Case with Handle and Shoulder Strap

Kern® [d] 2/5 & 10g, max.6/15 & 20kg Elegantly-Precision Baby Scale, *Medicaluse approved in Germany* **NEW**
 Ideal for Weighing Neonates in Paediatrics, with Feeding-& Hold-Function, 정밀형 신생아 체중계



2-Year Warranty

NEW

Medicaluse

(1), (2) Baby Scale



(3) Height Rod

* Figure ; Optional Height Rod Installed



(4) Optional Carrying Case

- Supplied by Kern® in Germany
- 2-Years Warranty
- CE & ISO 9001 Certified
- Verification Class III (Verification is Optional)
- ISO 13485 Certified
- Approval for Medical Use According to 93/42/EEC
- Ideally Suited for Weighing Neonates in Paediatrics
- * Robust ABS Plastic for Easy and Hygienic Cleaning
- * Feeding Function ; Difference Function for Calculating the Weight Gain before and after Feeding
- * Hold Function ; When Patients do not lie completely still, a Stable Weight is Calculated Using an Average Weight
- * Baby Weighing Pan ; 600×280×h55mm
- * Rubber Feet for Secure & non-Slip Positioning
- * Protective Working Cover
- * Batteries Included (6×1.5V AA)

Specifications & Ordering information

<M1>

Cat. No.	Weighing Range Max kg	Readability d kg	Verif. Value e kg	Dimensions (W×D×H) & Weight	Price, ₩
(1) KE.MBC.15K2DEM	6 / 15	0.002 / 0.005	0.002 / 0.005	600×407×120 mm,	513,340
(2) KE.MBC.20K10M	20	0.01	0.01	5.5 kg	552,070

Ea.	Price, ₩
	213,100
	96,870

(3) KE.MBC.A01 Optional ; Mechanical Height Rod, L80cm, 1mm Division

(4) KE.MBC.A02 ; Carrying Case, Only for Model without Height Rod



[d] 0.1kg, max.180 & 250kg

Kern® [d] 0.1kg, max.180 & 250kg Popular Maximum Body Scale, with Large LCD Display With Large · Flat Glass Weighing Plate, Ideal for Healthcare & Homecare, 가정용 스텝온 체중계 **NEW**

- Supplied by Kern® in Germany
- 2-Years Warranty
- CE & ISO 9001 Certified
- Large LCD Display and High-Contrast Display that is Easy to Read, Digit Height 40 & 50mm ; kg or lb
- Secure and Non-slip Positioning with Height-Adjustable Rubber Feet, Particularly Flat Design Facilitates Access
- * with Large · Flat · Sturdy Glass Weighing Plate
- * Easy and Hygienic Cleaning
- * Generous Weighing Capacity
- * Easy to Use and Time Efficient : Simply Tap on it, Stand on it, Read the Weight, Integrated AUTO-OFF Function
- * Battery Included, “MGD-100K-1” : 2ea×CR2032, “MGD-200K1L” : 3ea×1.5V AAA, Operating Time up to 100h

Specifications & Ordering information

<M1>

Cat. No.	Weighing -Range Max kg	Readability d kg	Weighing Plate Dimensions (W×D×H) & Weight	Price, ₩
KE.MGD.100K.1S05	180	0.1	300×300×19mm, 1.5kg	38,360
KE.MGD.200K.1LS05	250	0.1	380×330×27mm, 2kg	57,750



[d] 0.1kg, max.250kg

(1) “AC/DC겸용” with Backlight

Kern® [d] 0.1 & 0.2kg, max.250kg Step-on Floor Body Scale, Medicaluse approved in Germany With Large Display, Ergonomically Optimized Design, 의료용 스텝온 체중계 **NEW**

- Supplied by Kern® in Germany
- 2-Years Warranty
- CE & ISO 9001 Certified
- Approved as Medical Device according to 93/42/EEC
- ISO 13485 Certified
- * Easy to Use and Time Efficient : Simply Tap on it, Stand on it, Read the Weight.
- * Secure and Non-slip Positioning with Height-Adjustable Rubber Feet.
- * Large Platform with Non-Slip and Wear-Resistant Surface
- * Suitable for Easy and Hygienic Cleaning
- * Level Indicator Make to Level the Balance Precisely
- * Robust and Ergonomically Optimized Design
- * Dimensions of Display : 200×130×h60mm



[d] 0.2kg, max.250kg

(2) “DC용”

- (1) AC/DC겸용 with Backlight “MPD-M”
 - Large Backlight LCD Display, Digit Height 25mm
 - Mains Adapter External, Standard
 - Battery Operation Possible, 6ea×1.5V AA, Not Included, Operating Time up to 20h
- (2) DC용 “MPD-EM”
 - Large LCD Display without Backlight, Digit Height 25mm
 - Battery Operation, 6ea×1.5V AA, Included, Operating Time up to 20h

Specifications & Ordering information

<M1>

Cat. No.	Weighing -Range Max kg	Readability d kg	Verif. Value e kg	Weighing Plate Dimensions (W×D×H) & Weight	Price, ₩
(1) KE.MPD.250K.100M	250	0.1	0.1	365×360×80mm, 10 kg	561,750
(2) KE.MPD.200K.1EM	250	0.2	0.2		532,700



Step-on Function

Articles

Cat. No

Description

Kern® [d] 1/2g, max.5 & 8/15kg Compact Small Pet Scale, Plate Size 150×120mm & 252×200mm **NEW**
Stainless-steel with High Degree of Protection against Dust and Water Splashes, Bench-type, 소형 애완동물용 저울, 방수IP65-67

■ Supplied by Kern® in Germany

■ Stainless Steel Design of the Housing and Weighing plate, Its Smooth Surfaces Make it Simple to Clean

* Secure & Non-slip Positioning with Rubber Feet

* HACCP-Compliant Quality System.

■ CE & ISO 9001 Certified

* Protective Working Cover Included with Delivery

Features



Adjusting Program CAL



Weighing Unit



Protection Against Dust and Splashes IPxx



Stainless Steel



Battery Operation



Strain Gauges

NEW

2-Year Warranty



170×150×h40mm

(1) [d] 1g, Max. 5kg, "FOB_NS"



2-Year Warranty

285×255×h90mm

(2) [d] 1g/2g, Max. 8/15kg, "FOB_NL"

Specification

- Large LCD Display, Digit Height 20mm
- Batteries Included 9 V-Block, Running 24 hours
- Permissible Ambient Temperature 10°C~35°C
- Particularly Flat Design
- IP65 : Protected against Dust and Water Splashes

Specification

- Large Backlit LCD Display, Digit Height 25mm
- Batteries Included 4×1.5 V AA, Running 48 hours
- Permissible Ambient Temperature 5°C~35°C
- Dual-range Balance Switches Automatically to the Next Largest Weighing Capacity and Readability
- IP67 : Protected against Dust and Water Splashes

Specifications & Ordering information

<M1>

Cat. No.	Weighing -Range Max kg	Readability & Reproducibility d g	Linearity g	Overall Dimensions (w×d×h) & Weight	Weighing Plate (w×d×h)	Price(₩)
KE.FOB5K.3NS	5 kg	1 g	10	170×150×40mm, 0.8kg	150×120×10mm	203,420
KE.FOB10K.3NL	8 kg / 15 kg	1 g / 2 g	20	285×255×90mm, 3.8kg	252×200×14mm	445,530

Kern® [d] 5 & 10 & 20g, max.15 & 35 & 60kg Compact Veterinary Scale, for Diverse Applications, Plate Size 315×305mm
Stainless-steel, Painted Steel Base, with Wall Mount for Display, 수의과(동물병원)용 저울 **NEW**

NEW

2-Year Warranty

315×305×h57mm

**Specification**

- Large LCD Display : Digit Height 25 mm
- Dimensions of Display Device : 235×114×51mm
- Operating Time : up to 60h
- Permissible Ambient Temperature : 10°C~30°C

Stand ; Option

Figure ; Optional Stand,
(KERN EOB.A01N) Installed

Features



Adjusting Program CAL



Weighing Unit



Hold function



Battery Operation



AC 230V Adapter



Strain Gauges

■ Supplied by Kern® in Germany

* Simple and Convenient 4-key Operation

* Hold Function : When the Weighing Conditions are Unstable, a Stable Weight is Calculated Determining an Average Value

* Integrated AUTO-OFF Function to Preserve the Batteries

■ CE & ISO 9001 Certified

* Non-slip Rubber Mat & Protective Working Cover Included

* Optional Battery Operation, 6×1.5 V AA not Included

Specifications & Ordering information

<M1>

Cat. No.	Weighing Range Max kg	Readability d g	Reproducibility g	Linearity g	Weighing Plate (w×d×h) & Weight	Price(₩)
KE.EOB.15K5	15	5	5	± 10	315×305×57mm, 4kg	294,460
KE.EOB.35K10	35	10	10	± 20		294,460
KE.EOB.60K20	60	20	20	± 40		294,460

Ea. Price, ₩

KE.EOB.A01N Optional ; Stand to Elevate Display Device, Approx. h450mm

96,870

Kern® [d] 50g, max.150kg Affordable Veterinary Scale, Stainless-steel, Robust Platform 950×500mm **NEW**

Ideal for Weighing Large Animals, Suitable for Stationary or Mobile Use, 수의과(동물병원)용 대형 저울

NEW

3-Year Warranty



950×500×h58mm

Specification

- Large LCD Display, Digit Height 25mm
- Dimensions of Display Device : 235×114×h51mm
- Operating Time : up to 60h
- Permissible Ambient Temperature : 5℃~35℃



Including. Protective Working Cover

Features

- Adjusting Program CAL
- Weighing Unit
- Hold function
- Battery Operation
- AC 230V Adapter
- Strain Gauges



For Easy Transportation

■ Supplied by Kern® in Germany

■ Robust Platform Scale, Ideal for Weighing Large Animals

■ The Low Platform Height Facilitates Access

* Simple and Convenient 4-key Operation

* Hold Function : When the Weighing Conditions are Unstable, a Stable Weight is Calculated Determining an Average Value

* Integrated AUTO-OFF Function to Preserve the Batteries

* Non-slip Rubber Mat & Universal External Mains Adapter & Protective Working Cover included

* Optional Battery Operation, 4×1.5V AA not included

■ CE & ISO 9001 Certified

■ Wall Mount for Display Device Standard

* Easy to Move Using 2 Rollers and Handle

Specifications & Ordering information

<M1>

Cat. No.	Weighing Range Max kg	Readability d kg	Reproducibility g	Linearity g	Weighing Plate (w×d×h) & Weight	Price(W)
KE.EOS150K.50XL	150	50	50	±100	950×500×58mm, 17kg	765,120

Kern® [d] 1 & 10mg, max.350 & 2,500g Standard Precision Lab Balance, Compact, with Pcs. Counting **NEW**
 With Pre-Tare & Recipe Function, Freely Programmable Weighing Unit, 표준형 정밀 바란스, 계수계 겸용

NEW

(1) KE.PCB350.3



(2) KE.PCB2500.2



- Supplied by Kern® in Germany
- CE & ISO 9001 Certified
- Ideal for Standard Weighing Performance in Laboratory, with Compact Size
- 2-Year Warranty
- External Calibration

- * Pre-Tare Function for Manual Subtraction of a Known Container Weight, Useful for Checking Fill-Levels
- * Freely Programmable Weighing Unit, e.g. Display Direct in Special Units such as Length of Thread g/m, Paper Weight g/m²
- * With the Recipe Function you can Weigh the Different Ingredients of a Mixture, also Call up the Total Weight of all the Ingredients
- * Plus & Minus Weighing Procedures, e.g. Unit Weight Control, Fabrication Control etc.
- * Included Ring-Shaped Draught Shield Standard (Dimension : h90 × φ40mm), only for KE.PCB350.3
- * Included Protective Working Cover, for both of KE.PCB350.3 & KE.PCB2500.2
- * Backlit LCD Display, Digit Height 15mm
- * Batteries Operation ; 9V Block Standard, Operating Time up to 20h
- * Auto-Off Function to Preserve the Battery
- * Permissible Ambient Temperature : 5°C~35°C

Specifications & Ordering information

<L1>

Cat. No.	Weighing Capacity Max g	Readability d g	Reproducibility g	Linearity g	Dimensions & Weight (W×D×H, g)	Weighing Plate	Price, ₩
(1) KE.PCB350.3	350g	0.001g	0.002g	±0.005g	163×245×79mm, 1.1kg	φ81mm, Plastic with Conductive Lacquer	581,110
(2) KE.PCB2500.2	2,500g	0.01g	0.02g	±0.05g	163×245×79mm, 1.4kg	130×130mm, Stainless Steel	561,740

※ Optional Accessories are the Same as KB Models ⇒ See the Previous Page!

Kern® [d] 0.01g, max. 2,000g Reference Lab Balance, with Integrated Density Determination Function NEW

With Self-Explanatory Graphic 4 steps of Control Panel, 비중 측정형 랩 바란스, 참조용



2-Year Warranty



- Supplied by Kern® in Germany
- CE & ISO 9001 Certified
- 2-Years Warranty
- Ideal for Density Determination & Precision Weighing Performance in Education
- For Density Determination, Please Order the Following Optional Set (KE.YDB02) at the Same Time!
- Also with Carat Weighing Unit : [d]0.05ct, Max.10,000ct
- External Calibration

* The 4 steps are Carried Out from Left to Right :

- ① Tare Function
- ② Select Density Determination Mode
- ③ Weighing of Samples / Plummets in Air
- ④ Weighing of Samples / Plummets in Liquid

* Thanks to Self-Explanatory Graphic 4 steps Control Panel, the Density of Solids and Liquids can be Determined in Seconds

- * Large LCD Display, Digit Height 15mm
- * Permissible Ambient Temperature : 5°C~35°C
- * Batteries Operation ; 9V Block Standard, Operating Time up to 12h
- * Auto-Off Function to Preserve the Battery

* Hook for Underfloor Weighing : Objects which, because of their Size or Shape, cannot be Put on the Scale, can be Weighed by Means of Underfloor Weighing.



Specifications & Ordering information

<L1>

Cat. No.	Weighing Capacity Max g	Readability d g	Reproducibility g	Linearity g	Dimensions & Weight (W×D×H, g)	Weighing Plate (φ)	Price, ₩
KE.EMB2000.2V	2,000g	0.01g	0.02g	±0.05g	175×245×54mm, 0.85kg	φ 150, Plastic	484,260

Optional Accessories

		Ea. Price, ₩
KE.YKS.01	(1) Statistics Printer, "GLP" Capable, 0.75 lines/sec, Max. 40 Characters/line, with 112mm Paper & RS232, 165×140×50 mm, Adapter 230V/50Hz	755,440
KE.YKB.01	(2) Thermal Printer, "GLP" Capable, 0.75 lines/sec, Max. 40 Characters/line, with 112mm Paper, 165×140×50 mm, Adapter 230V/50Hz	600,500
KE.572.926	Interface Cable, PC or Thermal Printer, "YKS.01, YKB.01", L1.5m	89,110

Optional Set for Density Determination (Balance not Included)

■ Note : Balance and Appropriate Set for Density Determination should be Ordered at the same time!

* Complete Set with : Weighing Plate, Beaker(H135×φ100mm), Sample Holder, Plummets

	Ea. Price, ₩
KE.YDB02 Optional ; Set for Density Determination	639,240

(1) Statistics Printer (2) Thermal Printer



※ Figure ; Optional Set for Density Determination Installed

Kern® [d] 0.01g, max. 2,000g Convenient Lab Balance, φ 150mm Weighing Plate NEW

With Tare & Auto-Off Function, Hook for Underfloor Weighing, 다용도랩 바란스



2-Year Warranty



- Supplied by Kern® in Germany
- CE & ISO 9001 Certified
- 2-Years Warranty
- Ideal for Economical Precise Weighing Performance in Laboratory
- External Calibration

- * Hook for Underfloor Weighing : Objects which, because of their Size or Shape, cannot be Put on the Scale, can be Weighed by Means of Underfloor Weighing
- * Simple and Convenient 2-Key Operation
- * Tare Function : Used for Setting Weight to Zero, Facilitates Formulation Work
- * Auto-Off Function to preserve the battery
- * Large LCD Display, Digit Height 15mm
- * Batteries Operation ; 9V Block Standard
- * Permissible Ambient Temperature : 5°C~35°C



Simple and Convenient 2-Key Operation

Specifications & Ordering information

<L1>

Cat. No.	Weighing Capacity Max g	Readability d g	Reproducibility g	Linearity g	Dimensions & Weight (W×D×H, g)	Weighing Plate (φ)	Price, ₩
KE.EMB2000.2	2,000g	0.01g	0.01g	±0.05g	170×240×52mm, 0.75kg	φ 150, Plastic	436,830

Optional Accessories

		Ea. Price, ₩
KE.YKS.01	(1) Statistics Printer, "GLP" Capable, 0.75 lines/sec, Max. 40 Characters/line, with 112mm Paper & RS232, 165×140×50 mm, Adapter 230V/50Hz	755,440
KE.YKB.01	(2) Thermal Printer, "GLP" Capable, 0.75 lines/sec, Max. 40 Characters/line, with 112mm Paper, 165×140×50 mm, Adapter 230V/50Hz	600,500
KE.572.926	Interface Cable, PC or Thermal Printer, "YKS.01, YKB.01", L1.5m	89,110

(1) Statistics Printer (2) Thermal Printer

Articles

Cat. No

Description

Kern® [d] 0.1 & 0.2g, max.36 & 65kg High Precision Counting Scale, With Laboratory Function **NEW**
 With Self Explanatory Counting Function, <Germany-made>, 편리형 대용량 정밀 스케일/저울, 계수계 겸용

NEW

3-Year Warranty

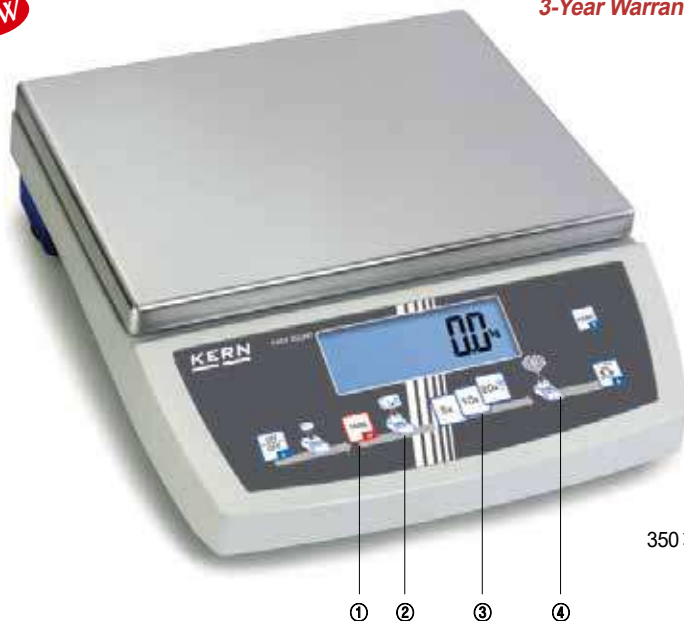











350 × 390 × h120mm

① ② ③ ④

The 4 steps are Carried Out from Left to Right

Features

-  External Calibration
-  Data Interface RS 232
-  Piece Counting
-  Totalising
-  % Determination
-  Weighing Unit
-  Weighing with Tolerance Range
-  Rechargeable Battery
-  AC 230V Adapter
-  Strain Gauges

Specification

- Backlit LCD Display : Digit Height 25mm
- Batteries Operation ; 6 × 1.5V Size C, Operating Time up to 40h
- Permissible Ambient Temperature : 10°C~40°C

■ CE & ISO 9001 Certified

■ 3-Year Warranty

■ Ideal for High Capacity Precision Weighing & Piece Counting Performance in Laboratory

■ Thanks to Self-explanatory Graphic Control Panel, Easy to Use, Ideal for Untrained Users

* The 4 steps are Carried Out from Left to Right :

- ① Place the Empty Container onto the Weighing Plate and Tare by Pressing the TARE Key
- ② Place the Reference Quantity for the Goods to be Counted into the Container (5, 10 or 20 pieces)
- ③ Confirm the Selected Reference Quantity by Pressing the Key (5, 10 or 20)
- ④ Pour in the Goods to be Counted. The Number of Pieces will Immediately be Shown in the Display

* **Two Balance in One** : Switching from Counting Mode to Weighing Mode at the Touch of a Key* **Precise Counting** : The Automatic Reference Weight Optimisation of Reference Weight Gradually Improves the Average Piece Weight Value

Specifications & Ordering information

<L1>

Cat. No.	Weighing Capacity Max kg	Read-ability d g	Smallest Part Weight Normal g / piece	Counting Resolution Point	Dimensions & Weight (W×D×H, kg)	Weighing Plate (W×D)	Price(₩)
(1) KE.CKE.36K0.1	36kg	0.1g	1g	360,000	350 × 390 × 120mm, 7kg	340 × 240mm, Stainless Steel	1,007,270
(2) KE.CKE.65K0.2	65kg	0.2g	2g	325,000			1,007,270

Optional Accessories

KE.FKB.A02S05 (3) Protective Working Cover, Weighing Plate Size 350 × 390 × h120mm, 5ea

Cs. Price, ₩

5ea 77,490

KE.YKS.01 (4) Statistics Printer, "GLP" Capable, 0.75 lines / sec, Max. 40 Characters / line, with 112mm Paper & RS232, 165 × 140 × 50mm, Adapter 230v / 50Hz

Ea. Price, ₩

755,440

KE.YKB.01 (5) Standard Printer, Capable, 0.75 lines/sec, Max. 40 Characters / line, with 112mm Paper & RS232

600,500

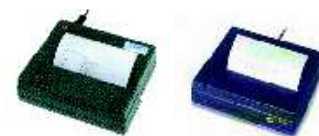
(4) Statistics Printer
KERN YKS.01(5) Thermal Printer
KERN YKB.01



(1)



(2)

(1) & (2) PP Volum™ Beaker

SciLab® PP Volum™ Beaker, with Precise Graduation · Spout, Autoclavable, 25~5,000ml
With or Without Handle, Hi-Transparency & Accuracy, 125/140℃ Stable, PP 계량 비커, 정밀눈금

- Made in Korea.
 - PP 25~5,000ml 정밀눈금부 다용도 계량 비커; 우수한-투명성·정밀성·내충격성·내약품성·내열성 (-10℃+125/140℃).
 - The PP Volum™ Beaker offers Multi-use in Laboratory & Industry, Volume Accuracy & High Transparency, and an Excellent Resistance of Acid/Chemicals/Impact/Temperature(-10℃+125/140℃).
- * Made of High-Grade Polypropylene(PP), With Precise Mould Graduation & Spout, Autoclavable.
* The Volume Graduation ; Measured by Water at Room Temperature 25℃

<L1>

(1) With Handle, PP, 250~5,000ml

			Ea.	Price, ₩
SL.Be3114	Vol.Beaker, PP, Handled, 250 / 10ml	, accu. approxi +1.6%, φ82×h98mm	New	1,370
SL.Be3115	, 500 / 10ml	, +1% , φ90×h133mm		1,460
SL.Be3116	, 1,000 / 10ml	, +1% , φ122×h167mm		1,750
SL.Be3117	, 2,000 / 20ml	, +0.3% , φ153×h200mm		4,070
SL.Be3118	, 3,000 / 50ml	, +1.7% , φ170×h240mm		8,140
SL.Be3119	, 5,000 / 100ml	, +2% , φ200×h270mm		10,650

(2) Without Handle, PP, Stackable, 25~5,000ml

			Ea.	Price, ₩
SL.Be3100	Vol.Beaker, PP, 25 / 5ml	, accu. approxi +0% , φ43×h50mm	New	780
SL.Be3101	, 50 / 5ml	, +2% , φ50×h61mm		490
SL.Be3102	, 100 / 10ml	, +2% , φ63×h75mm		880
SL.Be3104	, 250 / 10ml	, +2% , φ82×h93mm		970
SL.Be3105	, 500 / 10ml	, +1% , φ96×h128mm		1,260
SL.Be3106	, 1,000 / 10ml	, +1.2% , φ125×h145mm	New	2,740
SL.Be3107	, 2,000 / 20ml	, +1.9% , φ160×h185mm	New	5,470
SL.Be3108	, 5,000 / 100ml	, +0.8% , φ215×h260mm	New	12,560

, Stainless-steel



Beaker / Measure, 100~5,000ml

Stainless-steel High-performance Beaker/Measure, Medical-grade, 100~5,000ml
With Fine-graduation & -Safety Handle, 고품질 스텐계량컵/비커, 정밀눈금

- Made in Korea
- * Inner & Outer Precise Gradation
- * Medical-grade, Seamless and Polished Surface
- * (dia.) Size without Handle.

<L3>

			Ea.	Price, ₩
C9.1246	Beaker, SS, with handle / graduation, 100 / 25ml	, φ54×h58mm		9,070
C9.1247	, 200 / 20ml	, φ71×h66mm		10,330
C9.1248	, 300 / 50ml	, φ77×h77mm		15,110
C9.1249	, 500 / 50ml	, φ85×h110mm		20,770
C9.1250	, 1,000 / 100ml	, φ109×h126mm		27,690
C9.1251	, 2,000 / 200ml	, φ130×h150mm	New	34,610
C9.1252	, 3,000 / 500ml	, φ155×h180mm	New	44,050
C9.1261	, 5,000 / 500ml	, φ180×h210mm	New	55,370

Articles

Cat. No

Description



10 & 20Lit PE Convenient Water Aspiration Bottle, Square, with Stopcock & Handle & Screwcap Allow Water Supply without Air Removal, PE 편리형 사각 아스피레이터 바틀 **NEW**

- 세척이 용이하고 운반 및 사용이 편리함
- Material : Body-PE(Polyethylene), Stopcock-HDPE(High Density Polyethylene) & PP(Polypropylene) Screwcap-PP(Polypropylene), Autoclavable

- * Easy Cleaning Inside with Large Screwcap
- * Available for Only Water
- * Stopcock Tip Size : I.D φ 17mm / O.D φ 18mm
- * Mouth I.D φ 11.8 cm



<L2>

SL.Bot3411 Container, Square, PE, 10Lit, 215×350×h255mm
 SL.Bot3412 , 20Lit, 255×395×h320mm

Ea.	Price, ₩
	27,160
	28,750

, Centrifuge



250 & 500ml PP Centrifuge Bottle, with PP Screwcap, Autoclavable, -10°C + 125/140°C **NEW**
 Excellent Chemical Resistance, Translucent, <USA-made>, PP 원심관(병) / 大광구병

- 내구성, 내약품성 뛰어남
- 각사의 로터(히타치·쿠보타·토미·베크 맨·코쿠산등)에 적합한 원심병
- Material : Body/PPCO(Polypropylene Copolymer), Lid/PP(Polypropylene)

- * Centrifugal Resistance Max. 13,200 & 4800 G
- * Ideal for Large-Volume Cell Harvesting, Pelleting and Protein Purification
- * For Low- to Moderate-Speed Centrifugation of Biological and Chemical Samples
- * Maintain Stereength by Refrigerated Centrifuge -10°C

<L2>

SL.Bot3871 Centrifuge Bottles, 250ml, φ 61.8×125.2mm
 SL.Bot3873 , 500ml, φ 69.5×170.2mm

Ea.	Price, ₩	Pk.	Price, ₩
110,270		4ea	427,840
121,790		4ea	472,530

DURAN® Primary Packaging PURE Bottle & Screwcap, Developed for Pharma, GL25 · GL45 · GLS80, 25~20,000ml **NEW**
 Ideal for APIs & GMP Manufacturing, Clear & Amber, Qualification Package, Boro-glass 3.3, **퓨어바틀**, 제약 및 바이오 산업에 적합, 캡 발매

- Ready to Use
- Single Batch Delivery
- GMP & APIs
- COA & COC
- Retrace Code



(1) GL25 & GL45 PURE Bottles w/ Dust Cover, w/o Cap



(2) GLS80 PURE Bottles w/ Dust Cover, w/o Cap

(3) Optional Closures;



(c) GL45 Pouring Rings

■ **Supplied by DURAN® in Germany**

■ 제약 및 바이오 산업에 적합한 **DUST FREE** 바틀로 세척없이 바로 사용할 수 있고, COA · COC · 싱글 배치 공급이 가능하여 GMP 제조시설 및 APIs(원료의약품) 저장 & 이동에 용이함.

■ Application : GMP(Good Manufacturing Practices) Manufacturing of Pharmaceutical Drugs & Biotech Products, Storage & Transport of APIs(Active Pharmaceutical Ingredient), Bulk Drug Intermediates, Excipients and Media

■ Scope of the DURAN PURE Qualification Package; Download Documents at www.dwk.com

- Certificate of Conformity & Analysis
- Individual Certificates : BSE/TSE, USP, FDA Conformity, Certified for Food Applications, REACH, RoHS
- Qualification Documentation : Contains Information for Product and Supplier Qualification
- Questionnaire Processing / Customer Audit / Drug Master File Available on Request
- Change Service : by Registering and Initial Downloading, Customers are Automatically Informed about Changes to Products, New Analysis, or Test Results.

- * Glass Type I (USP, Ph.Eur., JP conformity)
- * Single Batch Certificate Delivery Available on Request
- * Sealed With Protective Dust Cover to Prevents Contamination During Storage & Shipment
- * Dust Cover is Made of High Density Polyethylene(HDPE); Not Autoclavable
- * Screwcaps can be Purchased Separately
- * 100% Traceability of All Manufacturing Steps
- * No Pre-cleaning Necessary



Sample COA & COC

(1) 25~20,000ml GL25 & GL45 PURE Bottle, Clear & Amber, with Dust Cover, without Cap <L1>

Spec.	Cat. No & Price	Clear				Amber			
		Cat. No.	Pk.	Price, ₩	Q'ty./Cs.	Cat. No.	Pk.	Price, ₩	Q'ty./Cs.
GL25, 25/15ml, φ36×h70mm		DU.8180114	10ea	87,040	94pk	DU.8180614	10ea	367,840	94pk
GL45, 100/10ml, φ56×h100mm		DU.8180124	10ea	82,350	54pk	DU.8180624	10ea	403,230	54pk
, 250/25ml, φ70×h138mm		DU.8180136	10ea	93,300	28pk	DU.8180636	10ea	484,610	28pk
, 500/50ml, φ86×h176mm		DU.8180144	10ea	108,010	36pk	DU.8180644	10ea	531,260	36pk
, 1,000/50ml, φ101×h225mm		DU.8180154	10ea	151,840	21pk	DU.8180654	10ea	747,580	21pk
, 2,000/100ml, φ136×h260mm		DU.8180163	10ea	311,810	12pk	DU.8180663	10ea	1,045,290	12pk
, 5,000/250ml, φ182×h330mm		DU.8180173	1ea	215,930	48pk	DU.8180673	1ea	380,570	48pk
, 10,000/500ml, φ227×h410mm		DU.8180186	1ea	413,510	30pk	DU.8180686	1ea	657,080	30pk
, 20,000/1,000ml, φ288×h505mm		DU.8180191	1ea	946,820	12pk	DU.8180691	1ea	1,552,510	12pk

(2) 500~20,000ml GLS80 PURE Bottle, Clear & Amber, with Dust Cover, without Cap

Spec.	Cat. No & Price	Clear				Amber			
		Cat. No.	Pk.	Price, ₩	Q'ty./Cs.	Cat. No.	Pk.	Price, ₩	Q'ty./Cs.
500/50ml, φ101×h148mm		DU.8186044	10ea	334,350	28pk	DU.8186644	10ea	1,390,270	28pk
1,000/50ml, φ101×h218mm		DU.8186054	10ea	397,270	21pk	DU.8186654	10ea	1,688,290	21pk
2,000/100ml, φ136×h248mm		DU.8186063	10ea	852,760	12pk	DU.8186663	10ea	2,441,810	12pk
5,000/250ml, φ182×h310mm		DU.8186073	1ea	380,570	48pk	DU.8186673	1ea	683,430	48pk
10,000/500ml, φ227×h385mm		DU.8186086	1ea	650,530	30pk	DU.8186686	1ea	1,052,160	30pk
20,000/1,000ml, φ288×h480mm		DU.8186091	1ea	1,407,680	12pk	DU.8186691	1ea	2,178,020	12pk

(3) Optional PURE Closures, GL25 · GL45 · GLS80, PE-packed

- * Autoclavable
- * USP <88> Class VI Pharmaceutical Quality
- * High Cleanliness Due to Manufacturing in Clean Rooms; DU.8910813~DU.8910886

- DU.8910813** (a) Screwcap, PFA, with Inert PTFE Coated Silicone Liner, GL25, φ32×h22mm
- DU.8910886** , GL45, φ51×h26mm
- DU.8911691** (b) , PSU, with Inert PTFE Coated Silicone Liner, GLS80, φ88×h40mm
- DU.8910888** (c) Pouring Ring, PFA, GL45, h4mm

Pk.	Price, ₩
5ea	58,240
5ea	110,510
5ea	350,150
5ea	34,200

Articles	Cat. No	Description
----------	---------	-------------

Wisdom PP Straight Sided **Volum™** Bottle, Precisely Graduated, Autoclavable, 25~1,000ml **NEW**
 Jar-type, Transparent, with BS Standard Large Neck Screwcap / Liner-less, 125/140°C, Good for Foodstuffs and Laboratory, **대광구 정밀농금 바틀**



- **Made in Korea**
- **Ideal for Foodstuffs and Laboratory for Storage of Samples, Powders, etc.**
- * Useful Straight Sided / Large Neck Bottles with Liner-less Screwcaps
- * Transparent Bottle and White Opaque Cap. BS Standard Thread
- * Good Chemical Resistance & High Temperature 125/140°C, Autoclavable

Article No	Capacity	Dimensions
DH.Con3012	25 / 5ml	φ37 × h37 mm
DH.Con3013	50 / 5ml	φ37 × h64 mm
DH.Con3014	125 / 12.5ml	φ58 × h60 mm
DH.Con3015	250 / 25ml	φ58 × h106 mm
DH.Con3016	500 / 50ml	φ92 × h95 mm
DH.Con3017	1,000 / 50ml	φ92 × h168 mm

Pk.	Price, ₩	Cs.	Price, ₩
5ea	5,760	12pk	63,890
5ea	6,710	9pk	55,820
4ea	6,420	9pk	53,370
4ea	10,680	6pk	59,250
4ea	14,020	2pk	25,950
4ea	15,300		

<L1>



(1) Narrow Neck Bottle, 4~60ml



(2) Wide Neck Bottle, 30 & 60ml

4~60ml PP Mini Lab Bottle, Narrow-& Wide-Neck, Excellent for Sealing with Inner Thread **NEW**
 Excellent Chemical / Heat Resistant, Translucent, 125/140°C Stable, Autoclavable, PP **미니바틀**

- * Used to Store a Small Amount of Sample
- * Complete Emptying is guaranteed through Inclination of Shoulders

(1) Narrow-Neck Bottle, 4~60ml

Article No	Capacity	Dimensions
DH.Bot3701	4ml	φ16 × h40 mm, Neck φ8mm
DH.Bot3702	8ml	φ25 × h43 mm, Neck φ13mm
DH.Bot3703	15ml	φ25 × h58 mm, Neck φ13mm
DH.Bot3704	30ml	φ34 × h61 mm, Neck φ13mm
DH.Bot3705	60ml	φ40 × h84 mm, Neck φ13mm

dh pk.	Price, ₩	Cs.	Price, ₩
10ea	2,320	10dh.Pk.	21,390
10ea	2,810	10dh.Pk.	25,950
10ea	3,310	10dh.Pk.	30,550
		12ea	5,320
		12ea	5,510

<L1>

(2) Wide-Neck Bottle, 30 & 60ml

Article No	Capacity	Dimensions
DH.Bot3714	30ml	φ35 × h61 mm, Neck φ21mm
DH.Bot3715	60ml	φ40 × h84 mm, Neck φ21mm

Cs.	Price, ₩
12ea	5,800
12ea	6,120



(1) 100 ~ 2,000ml



(2) 100 ~ 2,000ml

Wisdom HDPE **Volum™** Bottle, with DIN/GL-32 & 45 PP Screwcap, 100~2,000ml **NEW**
 Translucency & Opaque Amber, Precisely Graduated, -50°C +105/120°C Stable, HDPE **광구 랩바틀**, 정밀 눈금

- **Made in Korea**
- **Made of Good Chemical Resistant High Density Polyethylene(HDPE)**
- **Ideal for Multi-use Bottle of Liquids in Laboratory or Industry ; Reagent, Sample, Transportation and Long Term Storing**
- **With DIN/GL32 & 45 Basic Screwcap Attached, and the Cap has a Built-In Wedge Shaped Sealing Ring.**
- * Translucent and Amber for Light-Sensitive Materials
- * With Inner Pack / Reusable Zipper PE Bag.

(1) Translucent HDPE, Wide-Neck, Graduated, Cap Attached

Article No	Capacity	Dimensions
DH.Bot3642	100 / 10ml	φ52 × h102 mm
DH.Bot3643	GL 45, 250 / 25ml	φ65 × h136 mm
DH.Bot3644	500 / 50ml	φ80 × h169 mm
DH.Bot3645	1,000 / 50ml	φ95 × h221 mm
DH.Bot3646	2,000 / 100ml	φ125 × h261 mm

Pk.	Price, ₩	Cs.	Price, ₩
10ea	7,350	6pk	42,680
10ea	8,570	4pk	33,200
5ea	5,010	5pk	24,270
4ea	9,250	3pk	26,880
2ea	7,050	2pk	13,650

<L1>

(2) Amber HDPE, Wide-Neck, Graduated, Cap Attached

Article No	Capacity	Dimensions
DH.Bot3652	100 / 10ml	φ52 × h102 mm
DH.Bot3653	GL 45, 250 / 25ml	φ65 × h136 mm
DH.Bot3654	500 / 50ml	φ80 × h169 mm
DH.Bot3655	1,000 / 50ml	φ95 × h221 mm
DH.Bot3656	2,000 / 100ml	φ125 × h261 mm

Pk.	Price, ₩	Cs.	Price, ₩
10ea	8,310	6pk	48,270
10ea	9,830	4pk	38,110
5ea	5,730	5pk	27,730
4ea	10,500	3pk	30,530
2ea	8,160	2pk	15,830

(4) With Eco-Bulk Case with Cap Separately in PE Bag, Translucent & Amber Bottle, Graduated, Good for Industry

Translucent	Amber	Bottle Specification Wide-Neck, Precisely Graduation	Bulk Cs. Q'ty	Price, ₩	
				Translucent	Amber
DH.Bot3642.1	DH.Bot3652.1	Bulk Bottle, HDPE, W-N, GL32, 100 / 10ml , φ52 × h102 mm	140ea	85,090	97,560
DH.Bot3643.1	DH.Bot3653.1	, GL45, 250 / 25ml , φ65 × h136 mm	70ea	50,260	58,520
DH.Bot3644.1	DH.Bot3654.1	, 500 / 50ml , φ80 × h169 mm	40ea	32,470	37,660
DH.Bot3645.1	DH.Bot3655.1	, 1,000 / 50ml , φ95 × h221 mm	20ea	38,860	44,760
DH.Bot3646.1	DH.Bot3656.1	, 2,000 / 100ml, φ125 × h261 mm	10ea	27,920	32,930

Wisdom HDPE SQUARE Volum™ Bottle, Wide-neck, with DIN/GL-32 & 45 Basic Cap Attached, 100~1,000ml NEW

Precisely Graduated, Translucent, Good Chemical Resistance, 105/120°C Stable, HDPE 4각 광구 랩 바틀, 정밀눈금



- Made in Korea ■ Made of Good Chemical Resistant. ■ With Inner Pack / Reusable Zipper PE Bag.
 - Suitable for Multi-use Bottle of Reagent, Sample, Transfer, and Long Term Storing
- * With DIN/GL32 & 45 Basic Screwcap Attached, and the Cap has a Built-In Wedge Shaped Sealing Ring.

(1) SQUARE Bottle, Translucent HDPE, Wide-Neck, Graduated, Cap Attached

<L1>

DH.Bot	Capacity	Dimensions	Pk.	Price, ₩	Cs.	Price, ₩
DH.Bot3662	100 / 10ml	54 × 54 × h96 mm	10ea	7,130	6pk	41,420
DH.Bot3663	250 / 25ml	61 × 61 × h141 mm	10ea	8,520	4pk	33,030
DH.Bot3664	500 / 50ml	74.1 × 74.1 × h165 mm	5ea	5,340	5pk	25,850
DH.Bot3665	1,000 / 50ml	92.6 × 92.6 × h205 mm	4ea	9,500	3pk	27,630



(2) With Eco-Bulk Case, SQUARE Bottle, Translucent HDPE, Wide-Neck, Graduated, Good for Industry

DH.Bot	Capacity	Dimensions	Bulk Cs.	Price, ₩
DH.Bot3662.1	100 / 10ml	54 × 54 × h96 mm	140ea	82,380
DH.Bot3663.1	250 / 25ml	61 × 61 × h141 mm	70ea	49,990
DH.Bot3664.1	500 / 50ml	74.1 × 74.1 × h165 mm	40ea	34,790
DH.Bot3665.1	1,000 / 50ml	92.6 × 92.6 × h205 mm	20ea	40,020



4~60ml HDPE Mini Lab Bottle, Narrow-& Wide-Neck, Excellent for Sealing with Inner Thread NEW
Good Chemical Resistance, 105/120°C Stable, Non-Autoclavable, HDPE 미니라벨

- Made of High Density Polyethylene(HDPE), 105/120°C Stable
- * Used to Store a Small Amount of Sample * Complete Emptying is guaranteed through Inclination of Shoulders

(1) Narrow-Neck Bottle, 4~60ml

<L1>

DH.Bot	Capacity	Dimensions	dh pk.	Price, ₩	Cs.	Price, ₩
DH.Bot3721	4ml	16 × h40 mm, Neck φ 8mm	10ea	1,890	10dh.Pk.	17,400
DH.Bot3722	8ml	25 × h43 mm, Neck φ 13mm	10ea	2,510	10dh.Pk.	23,190
DH.Bot3723	15ml	25 × h58 mm, Neck φ 13mm	10ea	2,980	10dh.Pk.	27,520
DH.Bot3724	30ml	34 × h61 mm, Neck φ 13mm	12ea	5,410		
DH.Bot3725	60ml	40 × h84 mm, Neck φ 13mm	12ea	5,700		

(2) Narrow-Neck Bottle, Amber, 4~60ml

DH.Bot	Capacity	Dimensions	dh pk.	Price, ₩	Cs.	Price, ₩
DH.Bot3731	4ml	16 × h40 mm, Neck φ 8mm	10ea	2,320	10dh.Pk.	21,390
DH.Bot3732	8ml	25 × h43 mm, Neck φ 13mm	10ea	2,810	10dh.Pk.	25,950
DH.Bot3733	15ml	25 × h58 mm, Neck φ 13mm	10ea	3,310	10dh.Pk.	30,550
DH.Bot3734	30ml	34 × h61 mm, Neck φ 13mm	12ea	5,800		
DH.Bot3735	60ml	40 × h84 mm, Neck φ 13mm	12ea	6,120		

(3) Wide-Neck Bottle, 30 & 60ml

DH.Bot	Capacity	Dimensions	Cs.	Price, ₩
DH.Bot3744	30ml	35 × h61 mm, Neck φ 21mm	12ea	5,180
DH.Bot3745	60ml	40 × h84 mm, Neck φ 21mm	12ea	6,120

(4) Wide-Neck Bottle, Amber, 30 & 60ml

DH.Bot	Capacity	Dimensions	Cs.	Price, ₩
DH.Bot3754	30ml	35 × h61 mm, Neck φ 21mm	12ea	6,440
DH.Bot3755	60ml	40 × h84 mm, Neck φ 21mm	12ea	7,720

Articles

Cat. No

Description



DM.13.1001



DM.13.1002

UN Transport Container, PP, 1000ml, Secondary Container Including Absorbent · Cushioning Material · Labels For Safe Transport of Pathogenic Organisms & Clinical Specimens, 유엔 수송 용기, 스왑튜브 수송용 **NEW**

- WHO 감염성 물질 운송규정을 따른 용기
- 감염 물질 및 검체의 안전한 이동을 위한 수송용기(흡수패드 / 완충포장지 / 라벨 포함)
- Packaging for Infectious Substance (UN2814 / UN3373) ■ Tightly Sealed to Prevent Possible Leakage.
- * Category A : An Infectious Substance which is Transported in a Form that, when Exposure to it Occurs, is Capable of Causing Permanent Disability, Life-threatening or Fatal Disease in otherwise Healthy Humans or Animals. (S30.bot3001)
- * Category B : An Infectious Substance which does not Meet the Criteria for Inclusion in Category A. (S30.bot3002)
- * According to ISO 9001:2015 Quality Management System (K-QA-Q031478)

Specifications & Ordering information

<M5>

Cat No.	Total Volume (ml)	Internal Dimension (mm)	External Dimension (mm)	Empty Weight (g)	Pk.	Price, ₩
DM.13.1001	1,000	132×155	164×164×168	260g	10ea	100,000
DM.13.1002	1,000	107.5×176.3	112×110×190	147g	10ea	75,000

1~22Lit Clean-grade & UN-certified or not Bottle, Heavy-duty, Rectangle HDPE, with Leakproof Tamper Evident Screwcap **NEW**
With 10,000-Clean Grade & UN RTDG Certified, Good Resistance of Impact & Chemicals, -50°C + 105/120°C Stable, 크린바틀 & 안전바틀



(1) & (2) 4~22Lit Clean Grade & UN Certified Bottle

- Made in Korea ■ Ideal for Use in Clean Packaging · Foodstuffs · Fine Chemicals ; Storage & Transfer
- Certificated UN RTDG(Recommendation for Transport of Dangerous Goods), Specially Heavy Duty Structure
- Leakproof Structure Tamper Evident Screwcap and Good Resistance of Impact & Chemicals
- * Standard White Tamper Evident Screwcap : When the Screwcap is Opened, the Ring is Detached from the Screwcap, Ensuring Easy Recognition that the Container has been Opened.
- * Clean Bottle ; Clean grade 10,000 or Less, Clean-Washed, and Some Protection of UV
- * Standard White, Optional White(w/o Tamper Evident Ring) Screwcap and Blue Screwcap

(1) 4~22Lit Clean Grade & UN-RTDG Certified Bottle, Clean-Washed, Cap Attached, Packed in Poly Bag

<L1>

* 5Lit is not UN Certification, But Clean-grade !

- DH.Bot3352 Bottle, Rectangle, 4Lit , 120 × 190 × h270mm, Neck id. φ 38 mm
- DH.Bot3353 , 5Lit , 120 × 190 × h310mm, Neck id. φ 38 mm
- DH.Bot3354 , 20Lit, 230 × 290 × h370mm, Neck id. φ 48 mm
- DH.Bot3355 , 22Lit, 230 × 290 × h400mm, Neck id. φ 48 mm

dh pk.	Price, ₩	Cs.	Price, ₩
2ea	17,890	24ea	198,630
2ea	21,310	24ea	236,690
1ea	27,670	6ea	153,610
1ea	29,890	6ea	165,990



① 1Lit ② 5Lit ③ 10Lit
(3) Non UN Certified Bottle

(2) UN-RTDG Certified Bottle 4 · 20 · 22-Lit, Cap Attached

* RTDG ; Recommendation for Transport of Dangerous Goods

- DH.Bot3357 Bottle, Rectan., 4Lit , W-neck id φ 38mm, 120 × 190 × h270mm
- DH.Bot3358 , 20Lit, W-neck id φ 48mm, 230 × 290 × h370mm
- DH.Bot3359 , 22Lit, W-neck id φ 48mm, 230 × 290 × h400mm

Ea.	Price, ₩	Cs.	Price, ₩
	3,380	24ea	74,930
	10,770	6ea	59,830
	12,460	6ea	69,120

(3) Non UN-RTDG Certified Bottle 1 · 2 · 4 · 5 · 10-Lit, Cap Attached

- DH.Bot3361 ① Bottle, Rectan., 1Lit, N-neck id. φ 30mm, 60 × 128 × h210mm
- DH.Bot3362 , 2Lit, N-neck id. φ 30mm, 74 × 156 × h248mm
- DH.Bot3363 , W-neck id. φ 35mm, 76 × 153 × h250mm
- DH.Bot3364 , 4Lit, N-neck id. φ 30mm, 110 × 185 × h275mm
- DH.Bot3365 , W-neck id. φ 38mm, 120 × 190 × h270mm
- DH.Bot3366 , 5Lit, W-neck id. φ 38mm, 120 × 190 × h310mm
- DH.Bot3367 ② Bottle, Comfort Side Handle, 5Lit, N-neck id. φ 30mm, 148 × 180 × h310mm
- DH.Bot3368 ③ Bottle, Square, 10Lit, W-neck id. φ 48mm, 210 × 210 × h310mm

Ea.	Price, ₩	Cs.	Price, ₩
	2,450	30ea	70,890
	1,740	20ea	33,530
	1,840	50ea	84,610
	2,410	8ea	56,040
	3,380	24ea	74,930
	4,110	24ea	91,000
	2,910	6ea	67,390
	6,730	6ea	37,370

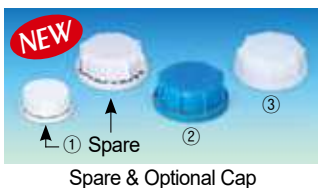

① Spare ② ③
Spare & Optional Cap



④ Optional Cap Opener

Spare & Optional Accessory

- DH.Cap3202 ① Spare Screwcap, with Evident Ring, id. φ 35 mm, for 2Lit, White
- DH.Cap3203 , id. φ 38 mm, for 4 · 5Lit, White
- DH.Cap3204 , id. φ 48 mm, for 20 · 22Lit, White
- DH.Cap3205 ② Optional Screwcap, with Evident Ring , id. φ 48 mm, for 20 · 22Lit, Blue
- DH.Cap3206 ③ , without Evident Ring, id. φ 48 mm, for 20 · 22Lit, White
- DH.Cap3207 , id. φ 48 mm, for 20 · 22Lit, Blue
- DH.Opn3002 ④ Optional Cap Opener/Jig for id. φ 48 mm, 20 · 22Lit Bottles

Ea.	Price, ₩
	590
	590
	970
	970
	970
	970
	1,940

4 Lit Clean-grade and General Purpose Bottle, Temper Evident, HDPE, 10,000-Clean Grade, with ASTM 38-400 Screwcap **NEW**
 Good Chemical Resistance, Can be used with Bottle Top Dispensers, -50°C +105/120°C Stable, 크린바틀 & 안전바틀



- Made in Korea ■ Ideal for Use in Clean Packaging · Foodstuffs · Fine Chemicals ; Storage & Transfer
- * Clean Bottle ; Clean grade 10,000 or Less, Clean-Washed, and Some Protection of UV. * Non Autoclavable
- * Can be Used with Bottle Top Dispensers with 38-400 Thread Adapter

(1) 4 Lit Clean Grade Bottle, with 38-400 Screwcap

DH.Bot3372 Bottle, Clean grade, 4Lit, ϕ 168×h305mm, neck id. ϕ 30 mm

<L1>			
Ea.	Price, ₩	Cs.	Price, ₩
	10,820	20ea	200,310

(2) 4Lit General Purpose Bottle, Comfort Handle, Non Clean-grade

DH.Bot3374 Bottle, Tamperproof, 4Lit, ϕ 156×h310mm, neck id. ϕ 30 mm

Ea.	Price, ₩	Cs.	Price, ₩
	20,570	10ea	199,530

, Sprayers



400~800ml PET Reversible Spray Bottle, High Transparent **NEW**
 Suitable for liquids Spray, PET 분무기, 어떤위치(거꾸로)로도 분주 가능

- Made in Korea ■ Works from any angle
- High Transparent PET(Polyethylene Terephthalate) Bottle
- * Ideal for Instant Sanitizer, water * Non-Autoclavable, up to 60°C
- * Anti-Spray Function for Safety * with Overhead Valve
- * Adjustable from a Fine Mist to a Narrow Jet Reaching 3~4 meter

DH.Bot3256 (1) Spray Bottle, PET, 400ml, ϕ 73×h219mm
 DH.Bot3257 (2) , 650ml, ϕ 87×h213mm
 DH.Bot3258 (3) , 850ml, ϕ 87×h245mm

<B1>	
Ea.	Price, ₩
	6,700
	7,070
	7,330



Air Pressure Sprayer, with Transparent Resin Bottle, 1.2 & 1.8-Lit **NEW**
 For General Purpose, with Graduation, Non-Breakage, Q-Mark, 다용도/강력 압축 분무기

- * Good for Water Compressing Spray
- * Non-Breakage Transparent PP Bottle
- * Stainless-steel Nozzle for Corrosion Resistance
- * Powerful Spray by Hand Pump Compressed Air
- * Adjustable from a Fine Mist to a Narrow Jet Reaching 7meter

0493-903 Air Pressure Sprayer, 170×130×290mm, 1.2Lit
 0493-902 , 180×140×310mm, 1.8Lit

<B3>	
Ea.	Price, ₩
	8,560
	9,800

Articles

Cat. No

Description

NEW

PP Multiuse Bowl, for Cleaning, with Flat Bottom, 3,500ml **NEW**

With Non-slip Grip, Practical and Simple Design, 다목적 대야·보울, 대형

■ 편안한 그립감과 심플한 디자인을 갖춘 다목적 대형 대야·보울

* Use Helps as Non-slip is by Structure that Comfortable Grip

* Material : PP

* Dimension : ϕ 395(outer), ϕ 360(inner), h130mm

* Color will be Delivered Randomly

<B1>

Ea.	Price, ₩
-----	----------

DH.Bow3001 Bowl, PP, 3,500ml, ϕ 395(outer)×h130mm

	6,120
--	-------

Articles

Cat. No

Description

NEW



(1) 2-layer



(3) 4-layer

PP Desk Drawer Cabinet, Multi-layer Classification Storage, w260×d195mm, h15~29cm
Durable, Suitable for Storing, Practical, 2~4단 서랍식 캐비닛, 서류정리함 **NEW**

- 뛰어난 내구성의 PP소재, 넉넉한 수납공간; 각종 서류, 문구, 생활 잡동사니 수납가능
- Ideal for Storing Documents and Organizing Office Supplies

* Made of Polypropylene * Easy to Use * Safe and Odorless * Good for Storing <B1>
* Keep Desk Clean and Tidy

DH.Dra3011	(1) Drawer, PP, 2-layer, w260×d195×h153mm, 605g	
DH.Dra3012	(2) , 3-layer, w260×d195×h223mm, 845g	
DH.Dra3013	(3) , 4-layer, w260×d195×h290mm, 1090g	

Ea.	Price, ₩
	18,340
	24,440
	30,560

, Tools 공구함

NEW



번호키 타입



알루미늄 공구함, Aluminium Tool Box

다국적

Safe & Secure 번호키 타입으로 편리하고 안전한 보관

※ 비밀번호 변경법

1. 다이얼 위 ①번 부분을 옆으로 밀니다
2. 밀고 있는 상태에서 번호를 바꿉니다
3. 번호를 바꾼후 ①번을 다시 원위치시킵니다

<B3>

ORDER NO.	MODEL NO.	PRICE, ₩ Ea.	규격(mm)	포장단위 Ea. / Pk.
0480-192	426105	39,200	355×325×135	1 / 2
0480-193	426205	47,040	445×370×145	1 / 2

NEW



공구함, Cantilever Tool Box

TURKEY

- 상단 공구함내 액세서리 수납가능
- 산업현장, 가정 등 다양한 환경에서 사용가능
- 알루미늄 손잡이로 가볍고 내구성이 우수

<B3>

ORDER NO.	MODEL NO.	PRICE, ₩ Ea.	규격(mm)	포장단위 Ea. / Pk.
0446-146	ASR-4016	36,270	500×283×248	1 / 6
0446-144	ASR-4017	40,190	560×300×277	1 / 6

NEW



멀티공구함 (전문가용), Technician Tool Box

TURKEY

- 수납용, 분리용 칸막이 설치
- 깊고 넓은 다용도 수납칸
- 용도에 맞는 공구 보관 용이

<B3>

ORDER NO.	MODEL NO.	PRICE, ₩ Ea.	규격(mm)	포장단위 Ea. / Pk.
0465-081	ASR-4025	53,910	490×405×136	1 / 4

NEW



멀티공구함, Pro-Mobile Tool Box

TURKEY



- 수레형 공구박스로 이동이 편리
- 견고하고 안전하게 공구류 보관
- 효율적인 공간 활용
- 상단부분 약세사리 수납 용이

<B3>

ORDER NO.	MODEL NO.	PRICE, ₩ Ea.	규격(mm)	포장단위 Ea. / Pk.
0454-916	ASR-2010	68,600	625×400×420	1 / 2

Articles

Cat. No

Description

NEW



멀티공구함, Mega Mobile Tool Box

TURKEY



- 수레형 공구박스로 이동 간편
- 깊고 넓어 수평기, 톱 등 다양한 공구류 보관용이
- 내구성 우수한 철재 잠금장치

<B3>

ORDER NO.	MODEL NO.	PRICE, ₩ Ea.	규격(mm)	포장단위 Ea./Pk.
0463-787	ASR-4026	93,110	725×500×465	1/1

NEW



Steel Tool Cart, with 2 Drawers · Shelf · Rubber Sheet · Mobile Casters & Brake **NEW**
 Functional Storage Solution for the Laboratory · Medical · Industry, 이동형 다용도 스틸 공구함

■ Supplied by SciLab Korea

- * Steel Body : Excellent Strength
- * Drawers Lock Adopted : Prevention Loss
- * Freely Configurable Use by Shelves & Drawers

0312-406 Tool Cart, 600×500×h895mm, 29kg

※ 운임 착불 <B3>

Ea.	Price, ₩
	209,440

NEW



Laboran[®] Syringe Brush, Gentle Cleaning for Syringe, ϕ 21~30mm NEW
 Made of Steel Wire, with Horse Hair & Special Both Hair, L200~300mm, 시린지용 브러쉬

<L2>

* Ideal for Cleaning Syringe

SL.Bru3095	Syringe Brush, Bristle L125 × ϕ 21, Total L200mm
SL.Bru3096	L150 × ϕ 25, Total L260mm
SL.Bru3097	L165 × ϕ 30, Total L300mm

Ea.	Price, ₩	Pk.	Price, ₩
	2,590	11ea	26,350
	3,560	11ea	36,220
	4,700	11ea	47,740

NEW



PET Sieve Brush, with Wood Handle, Bristle ϕ 25 × L50mm, Total Length 210mm NEW

Ideal for Removal Sieve Clogging & Corner, Hair Thickness 0.2~0.4mm, 시브 브러쉬, 체는 막힘 제거용

■ 시브 메시에 따라 전용 크기의 브러쉬 사용 가능

* Material : Bristle/PET(Polyethylene terephthalate), Grip/Wood, Tip/Tin-rolled

<L2>

SL.Bru3041	Sieve Brush, for 400~125 Mesh, Hair Thickness 0.2mm
SL.Bru3042	, for 100~65 Mesh, Hair Thickness 0.3mm
SL.Bru3043	, for 50 or less Mesh, Hair Thickness 0.4mm

Ea.	Price, ₩
	17,200
	17,200
	17,200

NEW



Heat Resistant All PP Brush, Autoclavable, -10°C + 125/140°C, L185mm, PP 브러쉬, 내열성 NEW

■ 모든 재질이 PP로 된 브러쉬

* Made of PP(Polypropylene), Autoclavable

* Possible to Use for Medical Products

<L2>

SL.Bru3101	Brush, PP, w15 × L185mm
SL.Bru3102	, w30 × L185mm
SL.Bru3103	, w50 × L185mm

Ea.	Price, ₩
	2,620
	2,930
	3,570

NEW



Blower Goat Hair Brush, with ABS Handle, Natural Rubber Pump, 블로워브러쉬 NEW

■ 공기를 내뿜어 먼지를 날리는 블로워(Blower)와 먼지를 제거하는 브러쉬(Brush)의 두가지 기능

■ Ideal for Dust Removal

* Material : Pump/Natural Rubber, Brush/Goat Hair, Handle/ABS

* Brush is Removable

<L2>

SL.Bru3085	Blower Brush, w52 × L119mm
SL.Bru3086	, w41 × L86mm

Pk.	Price, ₩
	13,790
	12,040

NEW



PP Beaker Brush, with Easy Grip PP Handle, Heat Resistant, 80°C NEW

Round Bristle in Front for Cleaning Bottom & Shoulders of Bottles, 비커/바틀 브러쉬

■ 직각 타입의 브러쉬 : 모서리, 구석부분 세척 용이

■ Material : Handle · Bristle/PP(Polypropylene)

* Available 2-way Washing : Rotary Washing or Vertical Washing

* Dual Structure Nylon Bristle & Easy Grip PP Handle

* Use a Round Bristle in Front, It can be Washed Clean the Bottom of the Bottle

* Quick & Easy Cleaning

<L2>

SL.Bru3091	Beaker Brush, Bristle L15(Max.23) × w20mm, Total L230mm
-------------------	---

Ea.	Price, ₩
	7,630

Articles	Cat. No	Description
----------	---------	-------------



PU Sponge Brush, for Bottles, with Easy Grip PP Handle NEW
 Ideal for Cleaning Bottom & Shoulders of Bottles, 국산 바들 브러쉬, 폴리우레탄 솔

- Made in Korea
- PU재질의 스펀지솔로 거품이 풍성하게 나며 병의 각진 바닥 부분도 깨끗하게 세척이 가능함
- * PU(Polyurethane) Bristles and PP(Polypropylene) Handle
- * Bristle made of PU helps to make Foam of Detergent and clean Bottom & Shoulders of Bottles easily <B1>
- * Color will be Delivered Randomly. (Blue · Pink)

DH.Bru3005 Brush, for Bottle, with PU Bristle & PP Handle, Bristle L80×φ52mm, Total L370mm	Ea. Price, ₩ 1,540
---	------------------------------

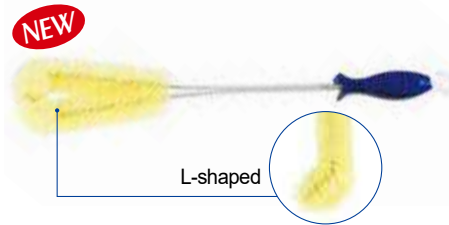

L-shaped Bottle PP Brush, with Styrole Resin Handle & Hook NEW
 Ideal for Reach Deep into Bottom of Bottles, Multi-use, L자형 다용도 병 세척솔 · 코너솔

- 닿기 힘든 병의 밑바닥과 코너부분을 깨끗하게 세척이 가능함
- * With L-shaped PP Bristle Ideal for Reach Deep into Bottom of Bottles
- * With Styrole Resin Handle & Hook
- * With Hook Ideal for Hanging to Dry and Store easily <B1>

DH.Bru3006 Brush for Bottle, with L-shaped PP Bristle, Bristle L130×55mm, Total 400mm	Ea. Price, ₩ 4,740
--	------------------------------



Silicone Brush, with 18/8 Stainless-steel Handle, Microwavable, L250mm NEW
 Ideal for Kitchen, Easy-to-use, Multi-use, -40℃+260℃, 실리콘 솔

- Made in Korea
- 100% 실리콘재질 브러쉬와 18/8 스테인레스재질의 손잡이
- * Material : Brush / Silicone, Handle / 18/8 Stainless-steel
- * Color will be Delivered Randomly <B1>

DH.Bru6011 Brush, Silicone, with 18/8 Stainless-steel Handle, φ45×L250mm	Ea. Price, ₩ 28,320
---	-------------------------------



All Silicone Brush, Multi-use, Heat Resistant at -40℃+260℃, L205mm, 실리콘 미니솔 NEW

- Made in Korea
- 100% 실리콘재질
- * -40℃+260℃ Heat Resistant
- * Color will be Delivered Randomly <B1>

DH.Bru6012 Brush, Silicone, φ35×L205mm	Ea. Price, ₩ 9,180
---	------------------------------



3M® Scotch® “503” Glass Bottle Brush, for glass, with Easy Grip Rubber Handle NEW
 Ideal for Cleaning Bottom- & Shoulders- of Bottles, 유리병 세척 브러쉬, 솔타입

- 손쉽게 유리병 내부 세척가능
- 박테리아로 인한 악취 억제용 항균제가 포함된 브러쉬
- * Ideal for Reach deep into Glasses and Bottles
- * Soft Comfort Grip
- * Long Lasting Bristles
- * Easy to Reach the Bottom of most Glassware

3M.02.2050 “503” Glass Bottle Brush, Bristle L80×φ60mm, Total L300mm	Pk. Price, ₩	Cs. Price, ₩
	1ea 3,800	6pk



3M® Scotch® “554” Household Scrubber Brush, with Easy Grip Rubber Handle NEW
 Various Purposes, Ideal for Cleaning Surface, 세척 강력 브러쉬

- 욕실, 베란다 등 다양한 장소에서 사용
- 뛰어난 내구성과 미끄럼 방지 핸들로 청소 용이
- * Ergonomic design - Easy to Hold and Use
- * Cleans Dirt from Tiles and Stained Floors <B4>
- * Heavy Nylon Bristles for Cleaning Tough Stains
- * Rubber Handle for Easy Grip

3M.02.2051 “554” Household Scrubber Brush, Bristle L130×w96×h53mm, Total L160mm	Pk. Price, ₩	Cs. Price, ₩
	1ea 4,350	6pk



3M® Scotch® “511P” Tile & Grout Brush, Ideal for Bathroom, Scour-power Brush NEW
 With PP Anti-slip Handle, Ergonomic Angled Handle, 타일 및 틈새용 브러쉬

- 닿기 힘든 틈새까지 청소 용이
- 욕실 틈새 · 바닥 · 욕조 변기 · 수도꼭지 등 다양하게 사용 가능
- * Ergonomic Angled Handle Cleans easily Bathroom.
- * Specially Designed with the Bathroom in Mind. <B4>
- * Nylon Scour-power Brush + PP Anti-slip Handle.

3M.02.2052 “511P” Tile & Grout Brush, Angled Handle, Bristle L50×w19×h31mm, Overall 260mm	Pk. Price, ₩	Cs. Price, ₩
	1ea 3,390	6pk

NEW



3M® Scotch® Toilet Cleaning Comfort Scrubber Brush, Extendable Aluminium Handle
Ideal for Cleaning Bathroom, with Non Scratch Scrubber, 길이 조절 화장실 브러쉬 **NEW**

■ 부드러운 흡집 방지 클리닝 헤드와 길이 조절 핸들로 손이 닿지 않는 곳 청소 용이

- * Handle Length can be Adjusted
- * Easy to Clean into Hard to Reach Places such as Toilet Ceiling
- * Adjustable Head Angle up to 180°
- * Slip-Resistant and Extendable Handle
- * No need to Bend the Back for Cleaning
- * Easily Removes Hard Water Spots and Soap Scum

<B4>

3M.02.2054 Toilet Scrub, Bristle L150×w100×h20mm,
Total L460mm(Max. 640)

Pk.	Price, ₩	Cs.	Price, ₩
1ea	9,660	6pk	

NEW



3M® Scotch® "552" Nylon Handy Brush, with PP Anti-slip Handle, Scour-power Brush
Ideal for Bathroom, One-touch Exchangeable Head, 욕실 및 욕조용 핸드 브러쉬 **NEW**

■ 구석진 곳까지 청소하기 쉬우며 나일론 브러쉬로 흡집 없이 사용 가능

■ 우수한 내구성 : 견고하고 튼튼해서 오랫동안 사용 가능

- * Effectively Cleans Dirt & Grime from the Grout Line.
- * Ergonomic Angled Handle Cleans easily Bathroom.
- * Nylon Scour-power Brush + PP Anti-slip Handle.

<B4>

3M.02.2053 "552" Nylon Handy Brush, Bristle 60×43×h25mm, Overall 220mm

Pk.	Price, ₩	Cs.	Price, ₩
1ea	4,080	6pk	

NEW



3M® Scotch® "555" Toilet Bowl Brush Set, Available Vertical & Horizontal Keep
With PP Anti-slip Handle & Holder, Ergonomic Angled Handle, Scour-power Brush, 변기용 브러쉬 세트 **NEW**

■ 변기 안쪽 구석을 닦을 수 있도록 디자인되어 청소용 용이

- * Specially Designed with the Toilet in Mind.
- * Convenient Holder.(Vertical & Horizontal Keep)
- * Ergonomic Angled Handle Cleans easily Toilet.
- * Nylon Scour-power Brush + PP Anti-slip Handle.

<B4>

3M.02.2055 "555" Toilet Bowl Brush Set, Scour-power, Bristle ϕ 100×110mm,
Overall 400mm

Pk.	Price, ₩	Cs.	Price, ₩
1ea	6,620	4pk	

NEW



3M® Scotch® "497" Nylon & Rubber Handy Wiper, with PP Anti-slip Handle
Ideal for Window & Glass, Ergonomic Angled Handle, 유리창닦이용 핸드 와이퍼 **NEW**

■ 밀착력이 뛰어나 유리나 거울을 얼룩 없이 말끔하게 닦을 수 있음

- * Excellent Adhesion Clean the Glass or Mirrors can be Neatly and Evenly.
- * Ergonomic Angled Handle Cleans easily Window
- * Nylon & Rubber Brush + PP Anti-slip Handle

<B4>

3M.02.2056 "497" Nylon & Rubber Handy Wiper, w260×L190mm

Pk.	Price, ₩	Cs.	Price, ₩
1ea	4,280	6pk	



NEW

Pre-Made Buffer

Essential Buffer for Biotechnology

Application :

- ✓ DNA Electrophoresis
- ✓ Southern(DNA) Blot Analysis
- ✓ Northern(RNA) Blot Analysis
- ✓ Western Blot Analysis

효율적 실험 · 연구를 위한 필요 Buffer

Save Time and Money!
Consistent and Accurate Results!

⚠ 화학물질관리법 제31조의 2에 따른 유해화학물질 시약 관리 안내

- 1) 시험용 · 연구용 · 검사용 시약은 해당 용도로만 사용하실 수 있습니다.
- 2) 취급시 유해화학물질 취급기준을 준수하여야 합니다.

세부 기준은 [화학물질관리법 시행규칙 별표 1]에서 확인하실 수 있습니다.

⚠ Guidance about Management of Hazardous Chemicals under Article 31-2 of the Toxic Chemicals Control Act

- 1) Reagents for Testing, Research or Inspection should be Used Only for That Purpose.
- 2) The Handling Standards for Hazardous Chemicals must be Observed.

For Details, Please Refer to [Annex 1 of Enforcement Regulations of the Chemicals Control Act].

모든 Buffer는 조성별, 용량별 주문 제작 가능합니다. 대용량 버퍼(5 & 10L) 구매시 버퍼 탱크를 무료로 제공해 드립니다.
All Buffers can be Customized by Composition and Capacity. Free Buffer Tank for Large Capacity Buffers (5 & 10L)



PB.AS500 Acrylamide-Bis Solution 30%, 29 : 1 C

Description

Acrylamide : Bis-acrylamide = 29 : 1, 30% Solution (w/v)

Application

For SDS-PAGE Analysis

Package	500ml
Price ₩	70,000

PB.AB10 6X Agarose gel loading buffer Type I C

Description

Bromophenol Blue 0.25%, Xylene cyanol 0.25%, Sucrose 40%

Application

For DNA Electrophoresis

Package	10ml
Price ₩	30,000

PB.AM20 Ampicillin Solution (100mg/ml) F

Description

Ampicillin Solution, 100mg/ml

Application

Use as a selective antibiotic for resistant bacteria and prevent bacterial contamination of cell cultures due to concerns of mammalian and insect cell toxicity

Package	20ml
Price ₩	80,000

PB.BS5 BSA Solution (100mg/ml) F

Description

Albumin fraction V, 100mg/ml

Application

Suitable for protein concentration determination

Package	5ml
Price ₩	80,000

PB.CC500 1M Calcium Chloride Solution RT

Description

Calcium Chloride 1M, Sterile Solution

Application

Suitable for molecular biology applications

Package	500ml
Price ₩	30,000

PB.CB1000 Coomassie Blue G-250 Staining Solution RT

Description

Methanol 50%, Acetic Acid 10%, Coomassie Blue G-250 0.05%

Application

Used for staining proteins in analytical biochemistry

Package	1L
Price ₩	60,000

PB.CB1000-02 Coomassie Blue R-250 Staining Solution RT

Description

Methanol 50%, Acetic Acid 10%, Coomassie Blue R-250 0.05%

Application

Used for staining proteins in analytical biochemistry

Package	1L
Price ₩	60,000

PB.CT250 CTAB Extraction Buffer RT

Description

CTAB (Cetyltrimethylammonium bromide) 2%, Tris-HCl pH 8.0 0.1M, NaCl 1.4M, EDTA pH 8.0 20mM

Application

Suitable for molecular biology applications

Package	250ml
Price ₩	30,000

PB.DT50 1M DTT F

Description

Dithiothreitol(DTT) 1M, Sodium Acetate 10mM, pH 5.2

Application

Used in preparing samples for electrophoresis or other applications

Package	50ml
Price ₩	120,000

PB.ED500 0.5M EDTA, pH 8.0 RT

Description

EDTA 0.5M, pH8.0. pH adjusted to 8.0 with NaOH

Application

Suitable for molecular biology applications

Package	500ml
Price ₩	35,000

PB.EB20 Ethidium Bromide Solution C

Description

Ethidium Bromide(EtBr) 10mg/ml Solution

Application

Used on agarose or acrylamide gel for band detection

Package	20ml
Price ₩	50,000

PB.GS250 50% Glycerol Solution C

Description

Glycerol Solution 50%, Sterile Solution

Application

For use in growth media

Package	250ml
Price ₩	40,000

PB.GH1000 4M Guanidine-HCl Solution RT

Description

Guanidine-HCl Solution 4M, Filtered Solution

Application

Used in the purification and extraction of mRNA, nucleic acids and proteins

Package	1L
Price ₩	400,000

PB.GE10 2% Gelatin Solution C

Description

Gelatin Solution 2%

Application

Used in coating cell culture plate and stabilizer of Taq DNA polymerase

Package	10ml
Price ₩	20,000

PB.IP20 IPTG Solution (0.1M) F

Description

IPTG(Isopropyl β-D-1-thiogalactopyranoside) Solution 0.1M

Application

IPTG functions by binding to the LacI repressor and altering its conformation, which prevents the repression of the β-galactosidase coding gene lacZ.

Package	20ml
Price ₩	40,000

PB.LY10 Lysozyme Solution (10mg/ml) F

Description

Lysozyme Solution 10mg/ml

Application

Used for lysing bacterial cells by hydrolyzing the peptidoglycan present in the cell walls.

Package	10ml
Price ₩	25,000



Pre-Made Buffer NEW

<L1>

<table border="1" style="width: 100%; border-collapse: collapse;"> <tr> <td style="background-color: #0056b3; color: white; padding: 5px;">PB.MC500</td> <td style="background-color: #0056b3; color: white; padding: 5px;">1M Magnesium chloride Solution</td> <td style="text-align: right; color: red; font-weight: bold; padding: 5px;">RT</td> </tr> <tr> <td colspan="3" style="padding: 5px;">Description Magnesium chloride Solution 1M, sterile filtered Solution</td> </tr> <tr> <td style="padding: 5px;">Package</td> <td colspan="2" style="padding: 5px;">500ml</td> </tr> <tr> <td style="padding: 5px;">Price ₩</td> <td colspan="2" style="padding: 5px;">100,000</td> </tr> <tr> <td colspan="3" style="padding: 5px;">Application Suitable for PCR as well as other molecular biology application</td> </tr> </table>	PB.MC500	1M Magnesium chloride Solution	RT	Description Magnesium chloride Solution 1M, sterile filtered Solution			Package	500ml		Price ₩	100,000		Application Suitable for PCR as well as other molecular biology application			<table border="1" style="width: 100%; border-collapse: collapse;"> <tr> <td style="background-color: #0056b3; color: white; padding: 5px;">PB.PS1000</td> <td style="background-color: #0056b3; color: white; padding: 5px;">Ponceau S Solution</td> <td style="text-align: right; color: red; font-weight: bold; padding: 5px;">RT</td> </tr> <tr> <td colspan="3" style="padding: 5px;">Description Ponceau S Solution 1X</td> </tr> <tr> <td style="padding: 5px;">Package</td> <td colspan="2" style="padding: 5px;">1L</td> </tr> <tr> <td style="padding: 5px;">Price ₩</td> <td colspan="2" style="padding: 5px;">110,000</td> </tr> <tr> <td colspan="3" style="padding: 5px;">Application For rapid (5min) staining of protein bands on nitrocellulose of PVDF membranes and also for satining protein on cullulose acetate membranes</td> </tr> </table>	PB.PS1000	Ponceau S Solution	RT	Description Ponceau S Solution 1X			Package	1L		Price ₩	110,000		Application For rapid (5min) staining of protein bands on nitrocellulose of PVDF membranes and also for satining protein on cullulose acetate membranes		
PB.MC500	1M Magnesium chloride Solution	RT																													
Description Magnesium chloride Solution 1M, sterile filtered Solution																															
Package	500ml																														
Price ₩	100,000																														
Application Suitable for PCR as well as other molecular biology application																															
PB.PS1000	Ponceau S Solution	RT																													
Description Ponceau S Solution 1X																															
Package	1L																														
Price ₩	110,000																														
Application For rapid (5min) staining of protein bands on nitrocellulose of PVDF membranes and also for satining protein on cullulose acetate membranes																															
<table border="1" style="width: 100%; border-collapse: collapse;"> <tr> <td style="background-color: #0056b3; color: white; padding: 5px;">PB.PB1000</td> <td style="background-color: #0056b3; color: white; padding: 5px;">1X PBS</td> <td style="text-align: right; color: blue; font-weight: bold; padding: 5px;">C</td> </tr> <tr> <td colspan="3" style="padding: 5px;">Description NaCl 137mM, KC1 2.7mM, NazHPO₄ 10mM, KH₂PO₄ 1.76mM, Sterile Solution</td> </tr> <tr> <td style="padding: 5px;">Package</td> <td colspan="2" style="padding: 5px;">1L</td> </tr> <tr> <td style="padding: 5px;">Price ₩</td> <td colspan="2" style="padding: 5px;">35,000</td> </tr> <tr> <td colspan="3" style="padding: 5px;">Application A standard phosphate buffer used in many biomolecular procedures applications</td> </tr> </table>	PB.PB1000	1X PBS	C	Description NaCl 137mM, KC1 2.7mM, NazHPO ₄ 10mM, KH ₂ PO ₄ 1.76mM, Sterile Solution			Package	1L		Price ₩	35,000		Application A standard phosphate buffer used in many biomolecular procedures applications			<table border="1" style="width: 100%; border-collapse: collapse;"> <tr> <td style="background-color: #0056b3; color: white; padding: 5px;">PB.RB500</td> <td style="background-color: #0056b3; color: white; padding: 5px;">RIPA Buffer</td> <td style="text-align: right; color: red; font-weight: bold; padding: 5px;">RT</td> </tr> <tr> <td colspan="3" style="padding: 5px;">Description RIPA Buffer 1X</td> </tr> <tr> <td style="padding: 5px;">Package</td> <td colspan="2" style="padding: 5px;">500ml</td> </tr> <tr> <td style="padding: 5px;">Price ₩</td> <td colspan="2" style="padding: 5px;">30,000</td> </tr> <tr> <td colspan="3" style="padding: 5px;">Application Used for rapid, efficient cell lysis and solubilization of protein from both adherent and suspension cultured mammalian cells</td> </tr> </table>	PB.RB500	RIPA Buffer	RT	Description RIPA Buffer 1X			Package	500ml		Price ₩	30,000		Application Used for rapid, efficient cell lysis and solubilization of protein from both adherent and suspension cultured mammalian cells		
PB.PB1000	1X PBS	C																													
Description NaCl 137mM, KC1 2.7mM, NazHPO ₄ 10mM, KH ₂ PO ₄ 1.76mM, Sterile Solution																															
Package	1L																														
Price ₩	35,000																														
Application A standard phosphate buffer used in many biomolecular procedures applications																															
PB.RB500	RIPA Buffer	RT																													
Description RIPA Buffer 1X																															
Package	500ml																														
Price ₩	30,000																														
Application Used for rapid, efficient cell lysis and solubilization of protein from both adherent and suspension cultured mammalian cells																															
<table border="1" style="width: 100%; border-collapse: collapse;"> <tr> <td style="background-color: #0056b3; color: white; padding: 5px;">PB.PB1000-02</td> <td style="background-color: #0056b3; color: white; padding: 5px;">1X PBS with Tween 20</td> <td style="text-align: right; color: blue; font-weight: bold; padding: 5px;">C</td> </tr> <tr> <td colspan="3" style="padding: 5px;">Description PBS 1X with Tween-20, pH 7.4</td> </tr> <tr> <td style="padding: 5px;">Package</td> <td colspan="2" style="padding: 5px;">1L</td> </tr> <tr> <td style="padding: 5px;">Price ₩</td> <td colspan="2" style="padding: 5px;">40,000</td> </tr> <tr> <td colspan="3" style="padding: 5px;">Application A standard phosphate buffer used in many biomolecular procedures applications</td> </tr> </table>	PB.PB1000-02	1X PBS with Tween 20	C	Description PBS 1X with Tween-20, pH 7.4			Package	1L		Price ₩	40,000		Application A standard phosphate buffer used in many biomolecular procedures applications			<table border="1" style="width: 100%; border-collapse: collapse;"> <tr> <td style="background-color: #0056b3; color: white; padding: 5px;">PB.RS10</td> <td style="background-color: #0056b3; color: white; padding: 5px;">RNase A solution (10mg/ml), DNase Free</td> <td style="text-align: right; color: green; font-weight: bold; padding: 5px;">F</td> </tr> <tr> <td colspan="3" style="padding: 5px;">Description RNase A 10mg/ml, Tris-HCl pH 7.5 10mM, NaCl 15mM, DNase Free</td> </tr> <tr> <td style="padding: 5px;">Package</td> <td colspan="2" style="padding: 5px;">10ml</td> </tr> <tr> <td style="padding: 5px;">Price ₩</td> <td colspan="2" style="padding: 5px;">150,000</td> </tr> <tr> <td colspan="3" style="padding: 5px;">Application Removal of RNA from preparations of plasmid DNA</td> </tr> </table>	PB.RS10	RNase A solution (10mg/ml), DNase Free	F	Description RNase A 10mg/ml, Tris-HCl pH 7.5 10mM, NaCl 15mM, DNase Free			Package	10ml		Price ₩	150,000		Application Removal of RNA from preparations of plasmid DNA		
PB.PB1000-02	1X PBS with Tween 20	C																													
Description PBS 1X with Tween-20, pH 7.4																															
Package	1L																														
Price ₩	40,000																														
Application A standard phosphate buffer used in many biomolecular procedures applications																															
PB.RS10	RNase A solution (10mg/ml), DNase Free	F																													
Description RNase A 10mg/ml, Tris-HCl pH 7.5 10mM, NaCl 15mM, DNase Free																															
Package	10ml																														
Price ₩	150,000																														
Application Removal of RNA from preparations of plasmid DNA																															
<table border="1" style="width: 100%; border-collapse: collapse;"> <tr> <td style="background-color: #0056b3; color: white; padding: 5px;">PB.PB1000-03</td> <td style="background-color: #0056b3; color: white; padding: 5px;">20X PBS</td> <td style="text-align: right; color: red; font-weight: bold; padding: 5px;">RT</td> </tr> <tr> <td colspan="3" style="padding: 5px;">Description NaCl 2.7M, KC1 54mM, NazHPO₄ 0.2M, KH₂PO₄ 35.2mM</td> </tr> <tr> <td style="padding: 5px;">Package</td> <td colspan="2" style="padding: 5px;">1L</td> </tr> <tr> <td style="padding: 5px;">Price ₩</td> <td colspan="2" style="padding: 5px;">65,000</td> </tr> <tr> <td colspan="3" style="padding: 5px;">Application A standard phosphate buffer used in many biomolecular procedures applications</td> </tr> </table>	PB.PB1000-03	20X PBS	RT	Description NaCl 2.7M, KC1 54mM, NazHPO ₄ 0.2M, KH ₂ PO ₄ 35.2mM			Package	1L		Price ₩	65,000		Application A standard phosphate buffer used in many biomolecular procedures applications			<table border="1" style="width: 100%; border-collapse: collapse;"> <tr> <td style="background-color: #0056b3; color: white; padding: 5px;">PB.RB100</td> <td style="background-color: #0056b3; color: white; padding: 5px;">RBC lysis buffer, 10X</td> <td style="text-align: right; color: red; font-weight: bold; padding: 5px;">RT</td> </tr> <tr> <td colspan="3" style="padding: 5px;">Description Red Blood Cell Lysis Buffer 10X</td> </tr> <tr> <td style="padding: 5px;">Package</td> <td colspan="2" style="padding: 5px;">100ml</td> </tr> <tr> <td style="padding: 5px;">Price ₩</td> <td colspan="2" style="padding: 5px;">80,000</td> </tr> <tr> <td colspan="3" style="padding: 5px;">Application To ensure optimal lysis of RBCs in single cell suspensions with minimal effects on leukocytes</td> </tr> </table>	PB.RB100	RBC lysis buffer, 10X	RT	Description Red Blood Cell Lysis Buffer 10X			Package	100ml		Price ₩	80,000		Application To ensure optimal lysis of RBCs in single cell suspensions with minimal effects on leukocytes		
PB.PB1000-03	20X PBS	RT																													
Description NaCl 2.7M, KC1 54mM, NazHPO ₄ 0.2M, KH ₂ PO ₄ 35.2mM																															
Package	1L																														
Price ₩	65,000																														
Application A standard phosphate buffer used in many biomolecular procedures applications																															
PB.RB100	RBC lysis buffer, 10X	RT																													
Description Red Blood Cell Lysis Buffer 10X																															
Package	100ml																														
Price ₩	80,000																														
Application To ensure optimal lysis of RBCs in single cell suspensions with minimal effects on leukocytes																															
<table border="1" style="width: 100%; border-collapse: collapse;"> <tr> <td style="background-color: #0056b3; color: white; padding: 5px;">PB.PH500</td> <td style="background-color: #0056b3; color: white; padding: 5px;">Phenol / CHCl₃ / IAA</td> <td style="text-align: right; color: yellow; font-weight: bold; padding: 5px;">☠ C</td> </tr> <tr> <td colspan="3" style="padding: 5px;">Description Phenol : Chloroform : Isoamylalcohol = 25 : 24 : 1, pH 8.0</td> </tr> <tr> <td style="padding: 5px;">Package</td> <td colspan="2" style="padding: 5px;">500ml</td> </tr> <tr> <td style="padding: 5px;">Price ₩</td> <td colspan="2" style="padding: 5px;">100,000</td> </tr> <tr> <td colspan="3" style="padding: 5px;">Application Used in the purification of nucleic acids</td> </tr> </table>	PB.PH500	Phenol / CHCl₃ / IAA	☠ C	Description Phenol : Chloroform : Isoamylalcohol = 25 : 24 : 1, pH 8.0			Package	500ml		Price ₩	100,000		Application Used in the purification of nucleic acids			<table border="1" style="width: 100%; border-collapse: collapse;"> <tr> <td style="background-color: #0056b3; color: white; padding: 5px;">PB.SS500</td> <td style="background-color: #0056b3; color: white; padding: 5px;">10% SDS Solution</td> <td style="text-align: right; color: red; font-weight: bold; padding: 5px;">RT</td> </tr> <tr> <td colspan="3" style="padding: 5px;">Description Sodium dodecyl sulfate (SDS) solution 10%, (w/v), filtered solution</td> </tr> <tr> <td style="padding: 5px;">Package</td> <td colspan="2" style="padding: 5px;">500ml</td> </tr> <tr> <td style="padding: 5px;">Price ₩</td> <td colspan="2" style="padding: 5px;">30,000</td> </tr> <tr> <td colspan="3" style="padding: 5px;">Application Suitable for molecular biology applications</td> </tr> </table>	PB.SS500	10% SDS Solution	RT	Description Sodium dodecyl sulfate (SDS) solution 10%, (w/v), filtered solution			Package	500ml		Price ₩	30,000		Application Suitable for molecular biology applications		
PB.PH500	Phenol / CHCl₃ / IAA	☠ C																													
Description Phenol : Chloroform : Isoamylalcohol = 25 : 24 : 1, pH 8.0																															
Package	500ml																														
Price ₩	100,000																														
Application Used in the purification of nucleic acids																															
PB.SS500	10% SDS Solution	RT																													
Description Sodium dodecyl sulfate (SDS) solution 10%, (w/v), filtered solution																															
Package	500ml																														
Price ₩	30,000																														
Application Suitable for molecular biology applications																															
<table border="1" style="width: 100%; border-collapse: collapse;"> <tr> <td style="background-color: #0056b3; color: white; padding: 5px;">PB.PS500</td> <td style="background-color: #0056b3; color: white; padding: 5px;">Phenol saturated for DNA, pH8.0</td> <td style="text-align: right; color: yellow; font-weight: bold; padding: 5px;">☠ C</td> </tr> <tr> <td colspan="3" style="padding: 5px;">Description Tris saturated phenol, pH8.0</td> </tr> <tr> <td style="padding: 5px;">Package</td> <td colspan="2" style="padding: 5px;">500ml</td> </tr> <tr> <td style="padding: 5px;">Price ₩</td> <td colspan="2" style="padding: 5px;">100,000</td> </tr> <tr> <td colspan="3" style="padding: 5px;">Application Used for a wide variety of molecular biology applications, including nucleic acid extractions using standard phenol-chloroform protocols.</td> </tr> </table>	PB.PS500	Phenol saturated for DNA, pH8.0	☠ C	Description Tris saturated phenol, pH8.0			Package	500ml		Price ₩	100,000		Application Used for a wide variety of molecular biology applications, including nucleic acid extractions using standard phenol-chloroform protocols.			<table border="1" style="width: 100%; border-collapse: collapse;"> <tr> <td style="background-color: #0056b3; color: white; padding: 5px;">PB.SA500</td> <td style="background-color: #0056b3; color: white; padding: 5px;">3M Sodium Acetate, pH 5.2</td> <td style="text-align: right; color: red; font-weight: bold; padding: 5px;">RT</td> </tr> <tr> <td colspan="3" style="padding: 5px;">Description Sodium Acetate 3M, pH 5.2</td> </tr> <tr> <td style="padding: 5px;">Package</td> <td colspan="2" style="padding: 5px;">500ml</td> </tr> <tr> <td style="padding: 5px;">Price ₩</td> <td colspan="2" style="padding: 5px;">25,000</td> </tr> <tr> <td colspan="3" style="padding: 5px;">Application Suitable for molecular biology applications</td> </tr> </table>	PB.SA500	3M Sodium Acetate, pH 5.2	RT	Description Sodium Acetate 3M, pH 5.2			Package	500ml		Price ₩	25,000		Application Suitable for molecular biology applications		
PB.PS500	Phenol saturated for DNA, pH8.0	☠ C																													
Description Tris saturated phenol, pH8.0																															
Package	500ml																														
Price ₩	100,000																														
Application Used for a wide variety of molecular biology applications, including nucleic acid extractions using standard phenol-chloroform protocols.																															
PB.SA500	3M Sodium Acetate, pH 5.2	RT																													
Description Sodium Acetate 3M, pH 5.2																															
Package	500ml																														
Price ₩	25,000																														
Application Suitable for molecular biology applications																															
<table border="1" style="width: 100%; border-collapse: collapse;"> <tr> <td style="background-color: #0056b3; color: white; padding: 5px;">PB.PK5</td> <td style="background-color: #0056b3; color: white; padding: 5px;">Proteinase K Solution (20mg/ml)</td> <td style="text-align: right; color: green; font-weight: bold; padding: 5px;">F</td> </tr> <tr> <td colspan="3" style="padding: 5px;">Description Proteinase K 20mg/ml, CaCl₂ 1mM, Tris-HCl pH 8.5 50mM, Glycerol 50%</td> </tr> <tr> <td style="padding: 5px;">Package</td> <td colspan="2" style="padding: 5px;">5ml</td> </tr> <tr> <td style="padding: 5px;">Price ₩</td> <td colspan="2" style="padding: 5px;">170,000</td> </tr> <tr> <td colspan="3" style="padding: 5px;">Application Used in molecular biology to digest protein and remove contamination from preparations of nucleic acid.</td> </tr> </table>	PB.PK5	Proteinase K Solution (20mg/ml)	F	Description Proteinase K 20mg/ml, CaCl ₂ 1mM, Tris-HCl pH 8.5 50mM, Glycerol 50%			Package	5ml		Price ₩	170,000		Application Used in molecular biology to digest protein and remove contamination from preparations of nucleic acid.			<table border="1" style="width: 100%; border-collapse: collapse;"> <tr> <td style="background-color: #0056b3; color: white; padding: 5px;">PB.SC500</td> <td style="background-color: #0056b3; color: white; padding: 5px;">5M Sodium Chloride Solution</td> <td style="text-align: right; color: red; font-weight: bold; padding: 5px;">RT</td> </tr> <tr> <td colspan="3" style="padding: 5px;">Description Sodium Chloride Solution 5M, filtered solution</td> </tr> <tr> <td style="padding: 5px;">Package</td> <td colspan="2" style="padding: 5px;">500ml</td> </tr> <tr> <td style="padding: 5px;">Price ₩</td> <td colspan="2" style="padding: 5px;">30,000</td> </tr> <tr> <td colspan="3" style="padding: 5px;">Application Suitable for molecular biology applications</td> </tr> </table>	PB.SC500	5M Sodium Chloride Solution	RT	Description Sodium Chloride Solution 5M, filtered solution			Package	500ml		Price ₩	30,000		Application Suitable for molecular biology applications		
PB.PK5	Proteinase K Solution (20mg/ml)	F																													
Description Proteinase K 20mg/ml, CaCl ₂ 1mM, Tris-HCl pH 8.5 50mM, Glycerol 50%																															
Package	5ml																														
Price ₩	170,000																														
Application Used in molecular biology to digest protein and remove contamination from preparations of nucleic acid.																															
PB.SC500	5M Sodium Chloride Solution	RT																													
Description Sodium Chloride Solution 5M, filtered solution																															
Package	500ml																														
Price ₩	30,000																														
Application Suitable for molecular biology applications																															
<table border="1" style="width: 100%; border-collapse: collapse;"> <tr> <td style="background-color: #0056b3; color: white; padding: 5px;">PB.PB1000-04</td> <td style="background-color: #0056b3; color: white; padding: 5px;">Paraformaldehyde 4%, / PBS</td> <td style="text-align: right; color: yellow; font-weight: bold; padding: 5px;">☠ C</td> </tr> <tr> <td colspan="3" style="padding: 5px;">Description Paraformaldehyde 4%, /1X PBS, pH7.2~7.6</td> </tr> <tr> <td style="padding: 5px;">Package</td> <td colspan="2" style="padding: 5px;">1L</td> </tr> <tr> <td style="padding: 5px;">Price ₩</td> <td colspan="2" style="padding: 5px;">110,000</td> </tr> <tr> <td colspan="3" style="padding: 5px;">Application Commonly used to preserve tissues for roution histology in many labs.</td> </tr> </table>	PB.PB1000-04	Paraformaldehyde 4%, / PBS	☠ C	Description Paraformaldehyde 4%, /1X PBS, pH7.2~7.6			Package	1L		Price ₩	110,000		Application Commonly used to preserve tissues for roution histology in many labs.			<table border="1" style="width: 100%; border-collapse: collapse;"> <tr> <td style="background-color: #0056b3; color: white; padding: 5px;">PB.SS1000</td> <td style="background-color: #0056b3; color: white; padding: 5px;">20X SSC</td> <td style="text-align: right; color: red; font-weight: bold; padding: 5px;">RT</td> </tr> <tr> <td colspan="3" style="padding: 5px;">Description Sodium Chloride 3M, Trisodium citrate 0.3M, filtered solution</td> </tr> <tr> <td style="padding: 5px;">Package</td> <td colspan="2" style="padding: 5px;">1L</td> </tr> <tr> <td style="padding: 5px;">Price ₩</td> <td colspan="2" style="padding: 5px;">35,000</td> </tr> <tr> <td colspan="3" style="padding: 5px;">Application For use in nucleic acid hybridizations and blot transfer applications</td> </tr> </table>	PB.SS1000	20X SSC	RT	Description Sodium Chloride 3M, Trisodium citrate 0.3M, filtered solution			Package	1L		Price ₩	35,000		Application For use in nucleic acid hybridizations and blot transfer applications		
PB.PB1000-04	Paraformaldehyde 4%, / PBS	☠ C																													
Description Paraformaldehyde 4%, /1X PBS, pH7.2~7.6																															
Package	1L																														
Price ₩	110,000																														
Application Commonly used to preserve tissues for roution histology in many labs.																															
PB.SS1000	20X SSC	RT																													
Description Sodium Chloride 3M, Trisodium citrate 0.3M, filtered solution																															
Package	1L																														
Price ₩	35,000																														
Application For use in nucleic acid hybridizations and blot transfer applications																															



PB.SH1000 10N NaOH (Sodium hydroxide Solution) RT

Description

Sodium hydroxide (NaOH) Solution 10N

Package	1L
---------	----

Application

Suitable for molecular biology applications

Price ₩	40,000
---------	--------

PB.TH500-02 1M Tris-HCl pH 8.0 RT

Description

Tris (hydroxymethyl) aminomethane buffer 1M, pH 8.0

Package	500ml
---------	-------

Application

Suitable for molecular biology applications

Price ₩	22,000
---------	--------

PB.SB500 Stripping Buffer RT

Description

Stripping Buffer

Package	500ml
---------	-------

Application

Removes primary and secondary antibodies from nitrocellulose and PVDF membranes to allow chemiluminescent Western blots to be reprobed

Price ₩	50,000
---------	--------

PB.TH500-03 1.5M Tris-HCl, pH 8.8 RT

Description

Tris (hydroxymethyl) aminomethane buffer 1.5M, pH 8.8

Package	500ml
---------	-------

Application

Suitable for molecular biology applications

Price ₩	30,000
---------	--------

PB.SB10 5X SDS-PAGE loading buffer w/ β -mercaptoethanol F

Description

Tris-HCl, pH 6.8 60mM, SDS 2%, β -mercaptoethanol 14.4mM, Glycerol 25%, Bromophenol Blue 0.1%

Package	10ml
---------	------

Application

Used in the SDS-PAGE analysis

Price ₩	30,000
---------	--------

PB.TG1000-02 10X Tris-Glycine Buffer (w / o SDS) RT

Description

Tris 0.25M, Glycine 1.92M

Package	1L
---------	----

Application

Used for sodium dodecyl sulfate - polyacrylamide gel electrophoresis (SDS-PAGE) of proteins

Price ₩	50,000
---------	--------

PB.TA1000 50X TAE Buffer RT

Description

Tris-Acetate 2M, EDTA 50mM

Package	1L
---------	----

Application

For electrophoresis of nucleic acids in agarose and polyacrylamide gels

Price ₩	62,000
---------	--------

PB.WD500 Water, DEPC treated RT

Description

Purified by ion exchange, carbon extraction, glass distillation, and filtration. Resistance greater than 18.0M ohms. Treated with DEPC(diethylpyrocarbonate)

Package	500ml
---------	-------

Application

For use in RNA/cDNA synthesis applications

Price ₩	40,000
---------	--------

PB.TB1000 10X TBE Buffer RT

Description

Tris 890mM, Boric Acid 890mM, EDTA pH 8.0 20mM

Package	1L
---------	----

Application

Used for DNA and RNA polyacrylamide gel electrophoresis

Price ₩	35,000
---------	--------

PB.WU1000 Water, Ultra Pure RT

Description

Water, Ultra Pure

Package	1L
---------	----

Application

Suitable for molecular biology applications

Price ₩	30,000
---------	--------

PB.TB1000-02 10X TBS with Tween-20 RT

Description

Tris 247mM, KCl 27mM, NaCl 1.37M, Tween-20 0.5%

Package	1L
---------	----

Application

Used as a wash solution for Western blot membranes and microtiter plate wells in ELISA assays

Price ₩	70,000
---------	--------

PB.XS5 X-gal Solution 20mg/ml F

Description

X-gal Solution 20mg/ml in DMF

Package	5ml
---------	-----

Application

Suitable for β -galactosidase assay applications

Price ₩	70,000
---------	--------

PB.TB1000-03 20X TBS Buffer RT

Description

Tris 494mM, KCl 54mM, NaCl 2.74M pH 7.4

Package	1L
---------	----

Application

Suitable for molecular biology applications

Price ₩	110,000
---------	---------

PB.DP1000 10X DPBS without Ca, Mg RT

Description

NaCl 1.37M, KCl 26.6mM, Na₂HPO₄ 80.5mM, KH₂PO₄ 14.7mM

Package	1L
---------	----

Application

Used to provide a buffer system to maintain cell culture media in the physiological pH range of 7.0 to 7.6

Price ₩	65,000
---------	--------

PB.TG1000 10X Tris-Glycine Buffer (w / SDS) RT

Description

Tris 0.25M, Glycine 1.92M, SDS 1%

Package	1L
---------	----

Application

Used for sodium dodecyl sulfate - polyacrylamide gel electrophoresis (SDS-PAGE) of proteins

Price ₩	50,000
---------	--------

Articles	Cat. No	Description
----------	---------	-------------

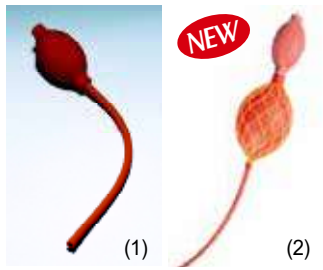

Pressure Rubber Bulb, 압력 벌브

■ Supplied by Witeg® in Germany(WI.-) & SciLab Korea(SL.-)

- WI.3157000** (1) Rubber Blowing Ball, Tubing Size id $\phi 5 \times L 200$ mm
- SL.Bul6041** (2) Rub. Safety Blowing Ball, Tubing Size id $\phi 4 \times L 570$ mm, w/Safety Cotton Net **New**

<L1>

Ea.	Price, ₩
	7,800
	9,910



Kovea® Gas Torch, Piezo-electric Auto-ignition, 135g NEW
 With Adjustable Flame, One-Touch Coupling, 가스 토치, 압전 자동점화

* 숯, 파이프 작업 등 다용도로 사용가능 * Size : 150×43×h200mm * Weight : 135g
 * Manual Ignition * Fuel : Butane * Gas Consumption : 80g / hr

K12.KT2211 Torch, Safety, 150×43×h200mm, 135g

<B3>

Ea.	Price, ₩
	11,680



Buffalo® Long Gas Torch, Brass, Excellent Hardness & Strength, 210mm×70mm NEW
 Various Uses, Max Temp 1800℃, 롱 가스토치, 다용도, 부탄가스사용

■ 야외활동이나 작업용 용접 등 다양한 활용 ■ Butane Gas(220g캔) 사용
 * Long Brass Brazier * Brass with Excellent Hardness and Strength
 * Various Application : Camping, Welding Etc. * Max Temp : 1800℃

BFL.801 Long Gas Torch, 210mm×70mm, Color : Blue

<B4>

Ea.	Price, ₩
	4,540



Kovea® Butane Gas Stove, Piezo-electric Auto-ignition NEW
 With Cylinder- & Screw-type Gas Connector, 오토 가스 스토브, 압전 자동점화

* Easy to burner control & Auto-ignition
 * Convenient Small size & Strong Fire Power
 * Easy Transport with Foldability of Pot Support & Legs
 * Allows Use at Temperatures Up to -10℃
 * Gas Consumption : 170g/hr(K12.JA1005), 246g/h(K12.JA0156)
 * Built in Flame Retention Device for wind(K12.JA1005)
 * Built in Fluorine Hose with Steel wire(K12.JA0156)

K12.JA1005 (1) Stove, Safety, 115×100×h90mm, 320g
K12.JA0156 (2) , 3 Burner Head, 100×100×90mm, 419g

<B3>

Ea.	Price, ₩
	29,400
	74,630

Convert Screw Type Stove to Cylinder Type Adapter & Butane Gas

K12.JAM2015 (3) Optional Screw- to Cylinder-type Adapter, Hose-type

Ea.	Price, ₩
	21,560

SUN 휴대용 부탄 가스렌지, Portable Butane Gas Range

KOREA



■ TY-101 : 가스 누설 방지 장치 ■ TY-108 : 폭발 2중 보완 장치 <B3>

ORDER NO.	MODEL NO.	PRICE, ₩	규격(mm)	중량(kg)
▶ 0448-549	TY-101	17,060	342×282×118	1.8
▶ 0448-550	TY-108	22,350	291×243×102	1.2

가스점화기, Auto Piezo-Lighter

* Safety Piezo · Electric Stick Lighter



(1) ARIM® <Korea> NEW
0512-571 "AGM-8801-II", 일반형, L250mm
0512-574 "AGM-8802TC-II", 터치식, L250mm

<B3>

Ea.	Price, ₩
	5,000
	11,370

(2) Bochem® <Germany>

* Randomly Delivered Colors

BC.7612 "PIEZO", Uni, L220mm

<L1>

Ea.	Price, ₩
	25,970



Butane Gas for Burner, Cylinder-type(220g) & Stove-type(230g), 부탄 가스 NEW

* Allows Use at Temperatures Up to -10℃

Cylinder Type, 가스렌지용, 220g

O3.S02115 (1) Premium Butane Gas, Cylinder Type, Click Contact, 220g
O3.S02203 (2) Butane Gas, Cylinder Type, Click Contact, 220g

<B4>

Ea.	Price, ₩	Pk.	Price, ₩
	1,190	28ea	33,040
	880	28ea	24,200

Stove Type, 등산·캠핑용, 230 & 450g

O3.S04207 (3) Butane Gas, Stove Type, Screw Contact, 230g
O3.S04013 (4) , 450g

Ea.	Price, ₩	Pk.	Price, ₩
	2,230	24ea	53,460
	4,270	12ea	51,110

Articles	Cat. No	Description
----------	---------	-------------

ABS Chemical-resist Assembly Cart, with Pan tray Shelf, and Caster, Multiuse of Foodstuff · Laboratory · Medical
 Good Resistance of Chemical & Corrosion, Best Durability, -40℃ + 85℃, 조립식 Plastic ABS 카트



(1) Basic-type



(2) Drawer-type



(3) Guardrail-type



(4) Drawer & Guardrail-type

■ Material ; Acrylonitrile Butadiene Styrene(ABS) Copolymer, 우수한 기계적·전기적·내약품성·내구성.

(1) Basic-type ABS Cart, with 2 · 3 · 4 Shelf

DH.Car30056R	Cart, ABS, 2 Shelf, 56×39×h54cm, Shelf Size(in) - 44×34cm, Shelf Distance - 27cm New
DH.Car30562	, 56×39×h82cm, - 44×34cm, - 56cm
DH.Car30662	, 66×46×h82cm, - 53×40cm, - 56cm
DH.Car30822	, 82×49×h82cm, - 68×44cm, - 56cm New
DH.Car30563	Cart, ABS 3 Shelf, 56×39×h82cm, Shelf Size(in) - 44×34cm, Shelf Distance - 27cm
DH.Car30663	, 66×46×h82cm, - 53×40cm, - 27cm
DH.Car30823	, 82×49×h82cm, - 68×44cm, - 27cm New
DH.Car30066R	Cart, ABS, 4 Shelf, 66×46×h112cm, Shelf Size(in) - 53×40cm, Shelf Distance - 27cm New
DH.Car30082R	, 82×49×h112cm, - 68×44cm, - 27cm New

※ 운임 착불 <L1>

Ea.	Price, ₩
	47,670
	53,370
	62,620
	89,470
	62,910
	74,890
	104,430
	107,560
	133,410

(2) Drawer-type ABS Cart, with 3 Shelf

DH.Car30563D	Cart, ABS, 3 Shelf, 1 Drawer, 56×39×h83cm, Shelf Size(in) - 44×34cm, Shelf Distance (Upper/Under Floor) - 17/28cm
DH.Car30663D	, 2 Drawer, 66×46×h83cm, - 53×40cm, - 20/28cm

Ea.	Price, ₩
	69,700
	84,400

(3) Guardrail-type ABS Cart, with 2 & 3 Shelf

DH.Car30562G	Cart, ABS, 2 Shelf, 56×39×h82cm, Shelf Size(in) - 44×34cm, Shelf Distance - 56cm
DH.Car30662G	, 66×46×h82cm, - 53×40cm, - 56cm
DH.Car30563G	Cart, ABS, 3 Shelf, 56×39×h82cm, Shelf Size(in) - 44×34cm, Shelf Distance - 27cm
DH.Car30663G	, 66×46×h82cm, - 53×40cm, - 27cm
DH.Car30823G	, 82×49×h82cm, - 68×44cm, - 27cm New

Ea.	Price, ₩
	61,530
	68,070
	75,150
	81,680
	122,140

(4) Drawer & Guardrail-type ABS Cart, with 2 & 3 Shelf

DH.Car30562GD	Cart, ABS, 2 Shelf, 1 Drawer, 56×39×h82cm, Shelf Size(in) - 44×34cm, Shelf Distance - 45cm
DH.Car30662GD	, 2 Drawer, 66×46×h82cm, - 53×40cm, - 47cm
DH.Car30563GD	Cart, ABS, 3 Shelf, 1 Drawer, 56×39×h83cm, Shelf Size(in) - 44×34cm, Shelf Distance (Upper/Under Floor) - 17/28cm
DH.Car30663GD	, 2 Drawer, 66×46×h83cm, - 53×40cm, - 17/28cm
DH.Car30823GD	, 82×49×h83cm, - 68×44cm, - 17/28cm New

Ea.	Price, ₩
	69,700
	77,610
	80,590
	92,570
	130,310

(5) Optional Handle **NEW**

DH.30562.HD	Optional, ① Handle, 36×9×7cm, for DH.Car30562, 30563, 30563D, 30562G, 30563G, 30562GD, 30563GD
DH.30662.HD	, ② , 42×8×7cm, for DH.Car30662, 30663, 30663D, 30662G, 30663G, 30562GD, 30663GD
DH.30822.HD	, ③ , 47×9×7cm, for DH.Car30822, 30823, 30823G, 30823GD

Ea.	Price, ₩
	1,110
	1,420
	1,890





ABS Two-way Drawer Dressing Cart, with 4 & 5 Drawer, with Handle NEW
Ideal for Lab · Medical · Industrial, with Stop-On Casters, 양방향 서랍식 Plastic 카트

■ **Made in Korea** * Open the Drawer Back and Forth * Accessory Drawer for Storage / Handling Convenience.
* Multi-Purpose : Laboratories, Hospitals, and Work Site for Transport and Storage

(1) 4-Drawer Dressing Cart

* 2 Drawer(39×43×h8cm) & 2 Drawer(39×43×h17cm)

DH.Car3064D4 Cart, ABS, 4 Drawers, 64×48×h85cm, Shelf Size(in) - 44×43cm, Drawer Size(in) - 39×43×8/17cm

※ 운임 착불 <L3>

Ea. Price, ₩

275,590

(2) 5-Drawer Dressing Cart

* 4 Drawer(39×43×h8cm) & 1 Drawer(39×43×h17cm)

DH.Car3064D5 Cart, ABS, 5 Drawers, 64×48×h85cm, Shelf Size(in) - 44×43cm, Drawer Size(in) - 39×43×8/17cm

Ea. Price, ₩

258,130

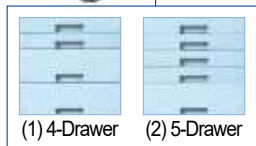

(1) 1~3 Drawer Dressing Cart



ABS Drawer Dressing Cart, with 3~6 Drawer, with Guardrail NEW
Ideal for Lab · Medical · Industrial, with Stop-On Casters, 서랍식 Plastic 카트

■ **Made in Korea** * Accessory Drawer for Storage / Handling Convenience.
* Multi-Purpose : Laboratories, Hospitals, and Work Site for Transport and Storage

(1) 1~3 Drawer Dressing Cart

* Shelf Size(in) - 55×43cm, Drawer Size(in) - 51×36×16cm

DH.Car3075D1 ① Cart, ABS, 1 Drawer, 74×48×h89cm
DH.Car3075D2 ②, 2 Drawers, 74×48×h89cm
DH.Car3075D3 ③, 3 Drawers, 74×48×h89cm

※ 운임 착불 <L3>

Ea. Price, ₩

256,880

306,430

351,890

(2) 4 Drawer Dressing Cart

* 2 Drawer(51×36×h8cm) & 2 Drawer(51×36×h16cm)

DH.Car3075D4 Cart, ABS, 4 Drawers, 74×48×h89cm, Shelf Size(in) - 55×43cm, Drawer Size(in) - 51×36×8/16cm

Ea. Price, ₩

330,330

(3) 5 & 6 Drawer Dressing Cart, with Detachable Hanger

* Shelf Size(in)-55×43cm, Drawer Size(in)-51×36×8/16cm

DH.Car3075D5 ④ Cart, ABS, 5 Drawers, 74×48×h89cm
DH.Car3075D6 ⑤, 6 Drawers, 74×48×h89cm

Ea. Price, ₩

355,820

334,420



(2) 4 Drawer Dressing Cart

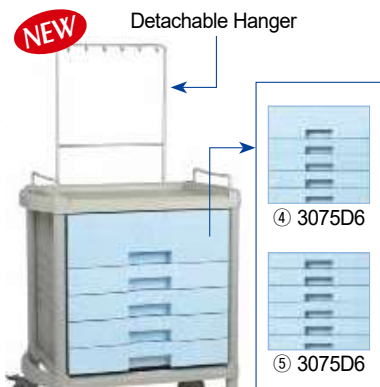

(3) 5 & 6 Drawer Dressing Cart



(1) With 2 Shelf, 85 & 90cm Height



(2) With 3 Shelf, 90cm Height

Stainless-steel Dressing Cart, with 2 & 3 Shelf and Guard Rails
For Lab · Medical · Industrial, with Stop-On Caster, 다용도 2 & 3단 카트

■ **Made in Korea** ■ **Guard Rails help Prevent Items from Slipping off Shelves.**
* Composed Stainless-steel Frame/Plate Shelves and Can be Fixed 4ea Casters.

(1) With 2 Shelf, 85 & 90cm Height

C9.4011 Cart, 2 Shelf, 50×40×h85cm
C9.4012, 60×43×h85cm
C9.401S, 65×45×h90cm
C9.401M, 75×45×h90cm
C9.401L, 95×45×h90cm

※ 운임 착불 <L3>

Ea. Price, ₩

96,900

110,740

166,110

193,800

235,330

(2) With 3 Shelf, 90cm Height NEW

C9.4014 Cart, 3 Shelf, 65×45×h90cm
C9.4015, 95×45×h90cm

Ea. Price, ₩

235,330

318,380

Articles	Cat. No	Description
----------	---------	-------------



Utility Stainless-steel Tray Shelved Cart, with Stop-On Caster
For Lab · Medical · Industrial, **트레이 선반식 다용도 카트**

■ *Made in Korea*

* 3cm Shelf Assistance Wall : Not Drop Equipment on Cart when Move

※ 운임 착불 <L3>

(1) 2 Tray Shelf-type

- C9.4021 Cart, 2 Shelf, 65×45×h90cm
- C9.4022 , 75×45×h90cm
- C9.4023 , 85×45×h90cm

Ea.	Price, ₩
	166,110
	193,800
	207,640



(2) 2 Shelf-type, with Guardrail & Handle

- C9.4032 Cart, 4 Side, 2 Shelf, 75×45×h95cm
- C9.4033 , 85×45×h90cm

Ea.	Price, ₩
	276,850
	318,380

(3) 3 Tray Shelf-type, Height Adjustable **NEW**

- C9.S609 Cart, 3 Shelf, 76×46×h90cm
- C9.S610 , 91×46×h90cm

Ea.	Price, ₩
	441,230
	588,310



(4) 3 Tray Shelf-type, with Handle

- C9.4027 Cart, 3 Shelf, 75×45×h90cm
- C9.4028 , 85×45×h90cm

Ea.	Price, ₩
	276,850
	318,380

(5) 3 Shelf-type, with Guardrail & Handle **NEW**

- C9.4035 Cart, 4 Side, 3 Shelf, 75×45×h95cm
- C9.4036 , 85×45×h95cm
- C9.4037 , 95×45×h95cm

Ea.	Price, ₩
	346,060
	373,750
	387,590



Utility Stainless-steel Cart, with 1~8 Wire Basket
Ideal for Drying, Storage, and Transfer, **건조 · 보관 · 운반용 다용도 카트**

■ *Made in Korea*

* with Stop-On Casters

※ 운임 착불 <L3>

(1) 1 Basket & 1 Shelf-type

- C9.4101 Cart, Multi-purpose, 65×50×h90cm

Ea.	Price, ₩
	338,280

(2) 2 Basket-type

- C9.4102 Cart, Multi-purpose, 65×50×h90cm

Ea.	Price, ₩
	367,700



(3) 3 Basket-type **NEW**

- C9.4103 Cart, with 3 Basket, 65×50×90cm

Ea.	Price, ₩
	470,650

(4) 8 Basket & 4 Shelf-type **NEW**

- C9.4432 Cart, with 8 Basket, 4 Shelf, 85×50×95cm

Ea.	Price, ₩
	1,088,360



Stainless-steel Cart, with Wire-Shelf · Wire-Basket
With Stop-On Caster, 와이어 선반 · 바스켓 서랍식 카트

■ **Made in Korea**

- * Clean, No Pollution, Long Life All Stainless-steel(SS) Products : Stainless-steel(SS) Frame, SS Plate Shelves and Position Consists of the Four Wheels as possible.
- * Purposes: (1) Laboratories, Hospitals, and Work Sites for Transport and Storage.
 (2) Laboratory Instruments and Accessories for Dry Cleaning.

※ 운임 착불 <L1>

(1) 2 Wire Basket-type

SL.Car7041 Cart, 2×Shelves, 75×40×h75cm

Ea.	Price, ₩
	282,690

(2) 3 Wire Shelf-type

SL.Car7042 Cart, 3×Shelves, 70×50×h100cm
SL.Car7043 , 90×50×h100cm

Ea.	Price, ₩
	325,220
	397,940

(3) 2 Basket-type, with 2 Drawer & Handle **NEW**

C9.4232 Cart, 2 Drawer & 2 Basket, 2 Shelf, 85×50×95cm

<L3>

Ea.	Price, ₩
	632,440

(4) 2 Shelf-type, with 3 Drawer **NEW**

C9.4242 Cart, 3 Drawer, 2 Shelf, 75×45×90cm
C9.4243 , 85×45×90cm

Ea.	Price, ₩
	691,270
	764,800



Stainless-steel Surgical Operating Add-Table, With 2 Shelf **NEW**
Good for Instruments & Tools, 수술준비대

■ **Made in Korea** ■ **High Quality Stainless-steel : Easy to Clean, Long Life-time**

※ 운임 착불 <L3>

(1) Straight Long-type

C9.4255 Operating Table, 2 Shelf, 90×50×h90cm
C9.4256 , 120×50×h90cm

Ea.	Price, ₩
	397,110
	470,650

(2) Curved-type, with Guardrail

C9.4250 Operating Table, 2 Shelf, 120×50×h90cm
C9.4251 , 160×50×h90cm
C9.4252 , 190×50×h90cm

Ea.	Price, ₩
	500,060
	632,440
	764,800



Laundry Bag Cart, with Stainless-steel Frame, 162 & 234Lit **NEW**
Good for Hospital, 세탁물 운반카트, 병원용에 적합

■ **Made in Korea**

※ 운임 착불 <L3>

(1) Without Lid

C9.4411 Cart, Laundry, 60×60×h85cm, 234Lit

Ea.	Price, ₩
	294,160

(2) With Lid Operated Foot Pedal (ON-OFF)

C9.4415 Cart, Laundry, 50×50×h85cm, 162Lit

Ea.	Price, ₩
	367,700

Foot Pedal
 (2) 발페달로 작동되는 뚜껑

Articles	Cat. No	Description				
(1) (2)	NEW	Aluminum Alloy Folding Hand Cart, Personal-type, Portable, Loading Capacity 70~90kg NEW Ideal for Shopping · Travelling · Moving Stuffs, Height Adjustable, Durable, 접이식 핸드카트 ■ 알루미늄 합금으로 제작하여 내구성이 뛰어나고 무거운 물건을 적재하고 이동이 가능 ■ 핸들 높이 조절 가능 (1) For Loading Capacity 70kg * Weight : 3.3kg * Specification : Full-280×390×h1,000mm, Folded-390×630×50mm DH.Car7001 Cart, Portable Hand, Loading Capacity 70kg				
(3) Folding Cart		(2) For Loading Capacity 80kg * Weight : 3.1kg * Specification : Full-280×390×h1,010mm, Folded-390×770×50mm DH.Car7002 Cart, Portable Hand, Loading Capacity 80kg (3) For Loading Capacity 90kg * Weight : 4.8kg * Specification : Full-340×490×h1,080mm, Folded-490×820×60mm DH.Car7003 Cart, Personal Hand, Loading Capacity 90kg				
		※ 운임 착불 <L4> <table border="1"> <thead> <tr> <th>Ea.</th> <th>Price, ₩</th> </tr> </thead> <tbody> <tr> <td></td> <td>48,400</td> </tr> </tbody> </table>	Ea.	Price, ₩		48,400
Ea.	Price, ₩					
	48,400					
		<table border="1"> <thead> <tr> <th>Ea.</th> <th>Price, ₩</th> </tr> </thead> <tbody> <tr> <td></td> <td>65,040</td> </tr> </tbody> </table>	Ea.	Price, ₩		65,040
Ea.	Price, ₩					
	65,040					
		<table border="1"> <thead> <tr> <th>Ea.</th> <th>Price, ₩</th> </tr> </thead> <tbody> <tr> <td></td> <td>80,170</td> </tr> </tbody> </table>	Ea.	Price, ₩		80,170
Ea.	Price, ₩					
	80,170					

MEGA 핸드 팔레트 트럭, Hand Pallet Truck

CHINA



(1) Popular 인기 보급형

MPT-2500L3	포크(mm)	
	폭×길이	높이(최대/최소)
	685×1,220	195/85

ORDER NO.	MODEL NO.	PRICE, ₩	용량(t)	중량(kg)
▶ 0518-529	MPT-2500L3	352,800	2.5	60

(2) Low Profile 저상형

MFL-1500	포크(mm)	
	폭×길이	높이(최대/최소)
	685×1,220	142/52

ORDER NO.	MODEL NO.	PRICE, ₩	용량(t)	중량(kg)
▶ 0299-432	MFL-1500	571,540	1.5	80

DAIHAN® 24-Places Hi-Speed Micro Centrifuge I. "Cef-M24" & II. -20°C Refrigerated "Cef-M24R", Max. 15,000rpm NEW
 With Aluminum Fixed-Angle Rotor for 0.2 · 0.5 · 1.5 · 2.0ml Tubes, Fast Cooling, 21,380 × g, **고속 마이크로 원심분리기, 일반형 & 냉각형**

NEW



I. "Cef-M24", Normal-type

NEW



II. "Cef-M24R", Refrigerated-type



(1) Fixed Angle Rotor "AS 24-2" ;
24 × 0.2 · 0.5 · 1.5 · 2.0ml Tubes
(Included)

Optional Rotors & Adapters



(2) Fixed Angle Rotor
"AS 36-05" ;
36 × 0.2 · 0.5ml Tubes

(3) Fixed Angle Rotor
"AS4-PCR8" ;
4 × PCR8/0.2ml Tubes



(4) Fixed Angle Rotor
"AS12-V5" ;
12 × 5ml Tubes
(Eppendorf)

(5) Fixed Angle Rotor
"AS 18-5" ;
18 × 5ml Tubes
(Round-Bottom)



①&② 0.2ml/0.5ml × 24
Tube Adapters

③ 0.2ml × 36
Tube Adapters

■ **CE Certified**

■ **바이오 세이프 로터/샘플 오버플로우 방지기능으로 원심분리기 작동 중 돌발적인 누출에 의한 미생물 오염 방지.**

- * Patented Multi-Flow Air Cooling Design Ensures Fast Cooling of the Rotor and Low Energy Consumption.
- * Bio-safe Rotor/Anti-sample Overflow Prevents Accidental Leakage during Centrifugal Process allowing Risk-free Microbial Contamination.
- * High Strength Aluminum Alloy Rotor can be Fully Autoclaved for Unlimited Service Life.
- * Ergonomic Electronic Lock Design, the Centrifuge Lid can be Closed with Single Finger Touch.
- * Each and Every Rotor is Hermetically Sealed by Three Rubber Seals.
- * Rotors are Seated on a Tapered Shaft, Concentric and Self-aligning, Perfect to Achieve Running Stability at High Speeds.
- * Rotor Imbalance Detection Alarm Function.
- * Rotation Speed/RCF Switchover, Inching Operation, Running Process Indicator, Sound Alert.
- * Up to 9 Program Storage Capacity According to Experimental Needs.

▶ **II. Refrigerated-type "Cef-M24R" : Powerful Cooling System for Precise Temp Control**

- Pre-cooling Program ensures Optimal Protection of the Sample before Warming
- Guaranteed 2°C Cooling within only 7 minutes of both Chamber and Samples even at max Speed.
- Lid Lock Facility allows for Internal Temp Maintenance even after Centrifugation.
- CFC-free Refrigerant, Low Carbon, and Environmental Protection.
- An External Condensation Tank Prevents Water Accumulation within the Centrifuge Chamber.

Specifications & Ordering information

<L1>

Spec.	Model	I. "Cef-M24" 24places, Normal-type	II. "Cef-M24R" 24places, Refrigerated-type
Speed Range		200~15,000rpm ±20rpm	
RCF		21,380×g	
Temp Range		-	-20°C+40°C
Rotor Capacity		Standard : 0.2 · 0.5 · 1.5 · 2.0ml × 24 Tubes Optional : 0.5ml × 36 Tubes, 5ml × 18 Tubes, 5ml × 12 Culture Tubes, PCR(8) × 4 Tubes	
Run Time		30sec~99min / Continuous	
Motor		Brushless DC Motor	
Noise Level		≤ 64dB	≤ 56dB
Safety Devices		Dual Door Interlock, Over-speed Detection, Over-temp Detection, Automatic Internal Diagnosis	
Acceleration & Breaking Time		≤ 25sec (at Max. speed)	
Dimension & Weight		280×364×h266mm, 12kg	332×553×h283mm, 30kg
Power Consumption		200W	500W
Electric Reqts.		AC220V-240V, 50Hz/60Hz, 5A	
Cat. No.		DH.CefM0024	DH.CefM0024R
Price, Each. ₩		1,808,950	4,174,500

* Other Specifications are available upon Customer's Request.

Spare Rotor and Tube Adapters

Ea. Price, ₩

DH.Rot8001 (1) Aluminum Fixed Angle Rotor, "AS 24-2", 24 × 0.2 · 0.5 · 1.5 · 2.0ml Tubes

250,470

Optional Rotor and Tube Adapters

Ea. Price, ₩

DH.Rot8002 (2) Aluminum Fixed Angle Rotor, "AS 36-05", 36 × 0.2 · 0.5ml Tubes

250,470

DH.Rot8003 (3) , "AS4-PCR8", 4 × PCR8/0.2ml Tubes

640,090

DH.Rot8004 (4) , "AS 12-V5", 12 × 5ml Tubes(Eppendorf)

250,470

DH.Rot8005 (5) , "AS 18-5", 18 × 5ml Tubes(Round-Bottom)

250,470

Pk. Price, ₩

DH.Ada3001 ① 0.2ml Tube Adapter-set, "A02P2", 24 Adapters/set, for Rotor "AS24-2"

24ea 53,440

DH.Ada3002 ② 0.5ml Tube Adapter-set, "A05P2", 24 Adapters/set, for Rotor "AS24-2"

24ea 53,440

DH.Ada3003 ③ 0.2ml Tube Adapter-set, "A02P05", 36 Adapters/set, for Rotor "AS36-05"

36ea 80,160

Examining Stool, Durable, Swivel & Soft Cushion, Footrest, Stable, Adjustable Height, $\phi 350 \times h450\sim600\text{mm}$ **NEW**

Ideal for Laboratory & Hospital, With or Without Caster, 실험·진찰 의자/결상

NEW



(1) With Caster



(2) Without Caster

■ **Made in Korea**

■ 고급 인조가죽으로 제작되어 내구성이 좋고 편안하고 폭신한 쿠션으로 착석감이 좋음

- * Adjustment Height Up to 600mm * Pre-Assembled Control
- * Light Weight * Easy to Move
- * without Back Cushion * Comfort & Soft Cushion

<L3>

Ea.	Price, ₩
(1)	71,730
(2)	71,730

- C9.4461** (1) Examining Stool, With Caster, $\phi 350 \times h450\sim600\text{mm}$
C9.4462 (2) , Without Caster, $\phi 350 \times h450\sim600\text{mm}$

NEW



Case

Buffalo® Foldable Lawn Chair Set, Pair, Steel Frame, Easy and Quick Installation **NEW**

520 × 500 × h900mm, Durability, Polyester Fabric, Easy to Carry, 접이식 캠핑 체어 세트(2Ea)

■ **휴대가 간편하고 내구성이 좋은 접이식 의자**

- * Durable Steel Frame * Mesh Pocket
- * Easy and Quick Installation * Easy to Carry
- * No Toxic Substances Detected * Long-Lasting Use without Sagging
- * Installation Size : 520 × 500 × H900mm / Storage Size : 150 × 150 × L910mm
- * Complete Set with : ① 2P Lawn Chair
 ② Carrying case

<B4>

Set.	Price, ₩
1	39,320

- BFL.701** Lawn Chair, Steel Frame, Polyester, 520 × 500 × H900mm, Color : Black

V.D.Heijden® COOL-CARE® 5 °C ~ 25 °C Air Cooled Chiller, Compact Table-top Design, Fill-1.6Lit, Cooling Capa 180W at 20°C **NEW**
 Max Pumping Capa 24Lit/min at 0.3bar, Prevent Cooling Water Consumption, <Germany-made>, 다용도 소용량 써클레이터/질러

NEW



- Made in Germany
 - 순환 냉각기의 원리로 작동하며, 농축기, 전기영동, 증탕기 등 여러 제품들과 사용 가능.
 - Applications : HPLC, Rotary Evaporators, Electrophoresis, Micro-Rotis, Soxleth, Water Baths, and Other More
 - Operates on the Principle of a Circulating Cooler
 - A Wear-resistant Microprocessor Controlled Unit Regulated a Container Heating Unit and Ensures a Very Precise Water Outlet Temperature.
- * 100% Water Savings
 - * Available with Higher Pump Pressure and a Lower Temperature Range
 - * Temperature of Cooling Water Can be Set as Required
 - * Minimal Space Requirements on Any Laboratory Table
 - * Suitable for Wide Range of Uses
 - * Exceptionally Easy to Use
 - * Virtually Silent in Operation

Specifications & Ordering information

<L1>

Spec.	Model	COOL-CARE® -16
Cooling Capacity		180 W at 20°C
Temperature Range		5 ~ 25°C
Ambient Temperature		Approved up to +28°C
Pumping Capacity Max.		24 Lit/min
Feed Pressure Max.		0.4 bar
Connections		3/8" Quick Lock Coupling Rear of Unit
Tank Contents		1.6 liter
External Dimension & Weight		290 × 450 × h270 mm, 15kg
Type of Current		230 V / 50 Hz / 1 PH / N / PE
Power Consumption		160 W max.
Refrigerant		R134a (CFE-free)
Cat. No.		VD.3010
Price, Each. ₩		5,097,730

V.D.Heijden® MINORE® 16 °C ~ 22 °C Circulatory Cooling Unit, Compact Tank, Fill-5Lit, Cooling Capa 300W at 20°C **NEW**
 Max Pumping Capa 28Lit/min at 0.3bar, Ideal for Cool the Circulating Water & Antifreeze Mixture, <Germany-made>, 다용도 중용량 써클레이터/질러

NEW



- Made in Germany
 - 전자식 전원 제어 기능으로 매우 일정한 온도를 자랑하며, 회전식 증발기, 증류장치, 유기용매 추출 등 다양편으로 사용이 가능.
 - Applications : Rotation Evaporators, Distillation Devices, Soxleth Extractions, Water Baths
 - The Container is Filled From Under the Hinged Cover on the Top of the Unit and is Easily Accessible.
- * 100% Water Savings in Tap Water
 - * Cooling Water Temperature, Pressure and Flow can be Regulated
 - * Constant Water Quality, No lime, No algae
 - * Almost Noiseless
 - * Available with Higher Pump Pressure and Many Different Options and Accessories
 - * No Sewage Costs for Waste Water
 - * Minimum Space Requirements on Every Laboratory Table
 - * Temperature Display in O-LED Capacitive Touch Pad Controller

Specifications & Ordering information

<L1>

Spec.	Model	MINORE® 0-A-RB400
Cooling Capacity		300 W at 20°C
Temperature Range		16 ~ 22°C
Ambient Temperature		Approved up to +32°C
Pumping Capacity Max.		28 Lit/min
Feed Pressure Max.		0.4 bar
Connections		Quick Lock Coupling with 9 mm Hose Sleeve
Tank Contents		5 Lit
Dimensions W×D×H		360 × 470 × 590 mm
Type of Current		230 V / 50 Hz / 1 PH / N / PE
Power Consumption		220 W
Weight		31 kg
Refrigerant		R290
Cat. No.		VD.3011
Price, Each. ₩		6,688,980

Articles	Cat. No	Description
----------	---------	-------------

※ Hammacher® Premium Maintenance Service for Diamond Coating, Sharpening, Refinishing & c.
⇒ See the “Forceps” Section.

Hammacher® Premium Haemostatic Forceps/Tubing Clamp, with Serrated Clamp Heads, L120~140mm, *Medicaluse approved* **NEW**
Crile · Halsted · Kelly · Kocher · Mosquito-Forceps, Stainless-steel 410, 프리미엄 지혈 겸자 포셉 및 튜빙 클램프 겸용, 독일제 의료용 & 랩 겸용

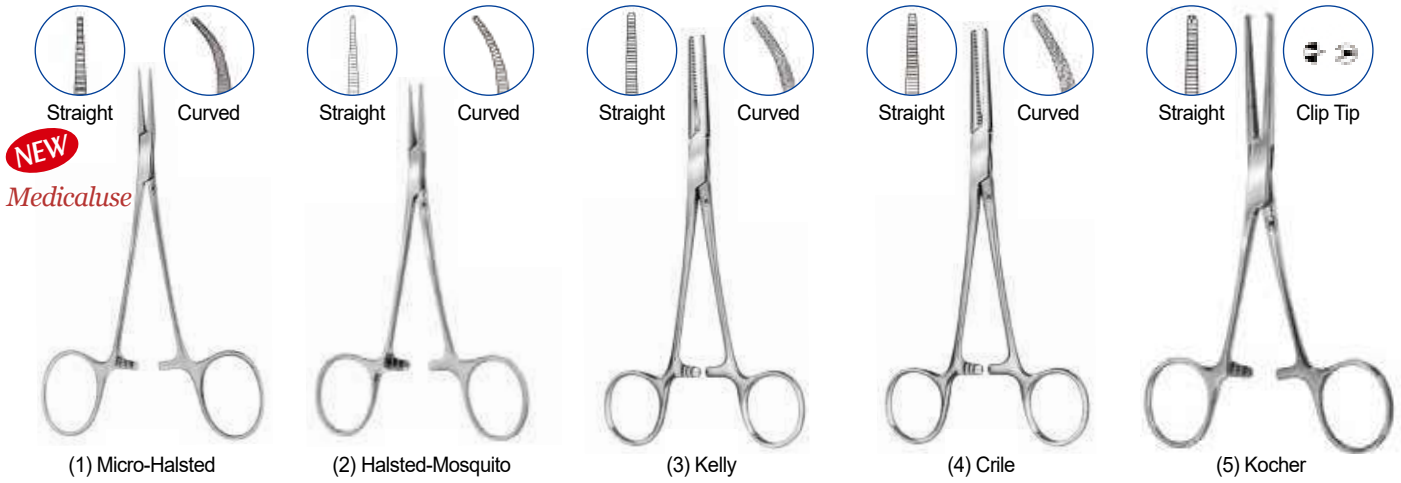

- Germany-made 프리미엄급; 비부식, 고강도, 고경도, 내약품성
- 용도 : 조직이나 혈관을 잡거나 조작, 압박, 절단, 결합, 또는 호스나 튜브를 고정시켜 기밀을 유지하는 등 다목적 기구
- 격자로 된 홈이 있는 팁이 미끄러지지 않게 잡도록 도와주고, 가위형 손잡이로 간편하게 고정시키거나 잡을 수 있음
- Stainless-steel 410 : Rust-proof, High-Strength/Hardness, Chemical Resistance

(1) Micro-Halsted Forceps, L125mm, 마이크로-할스테드 포셉

* 작은 섬유조직을 잡을 때 유용 * Very Delicate model

		<M1>
		Ea. Price, ₩
HA.HSE016.12	Forceps, SS, Micro-Halsted, Straight, L125mm	41,520
HA.HSE017.12	, Curved, L125mm	42,890

(2) Halsted-Mosquito Forceps, L120mm, 할스테드-모스키토 포셉

* 작은 섬유조직을 잡을 때 유용

		Ea. Price, ₩
HA.HSE022.12	Forceps, SS, Halsted-Mosquito, Straight, L120mm	38,130
HA.HSE023.12	, Curved, L120mm	39,680

(3) Kelly Forceps, L140mm, 켈리 포셉

* 비교적 큰 조직을 잡을 때 유용

		Ea. Price, ₩
HA.HSE044.14	Forceps, SS, Kelly, Straight, L140mm	44,880
HA.HSE045.14	, Curved, L140mm	45,820

(4) Crile Forceps, L140mm, 크리얼 포셉

* 비교적 큰 조직을 잡을 때 유용

		Ea. Price, ₩
HA.HSE048.14	Forceps, SS, Crile, Straight, L140mm	44,590
HA.HSE049.14	, Curved, L140mm	45,820

(5) Tissue Kocher Forceps, with Clip Tip 1:2, L160mm, 코카 포셉

* 비교적 크고 단단한 조직을 잡을 때 유용

		Ea. Price, ₩
HA.HSE088.16	Tissue Forceps, SS, Kocher, Straight, with Clip Tip 1:2, L160mm	54,430

Articles

Cat. No

Description



Bochem® ϕ 30~65mm Grip Silicone-coated 360° Swivel Clamp, Steam od ϕ 12mm, L150mm
 For Condenser & Column, Malleable Cast Iron, 회전형 실리콘 코팅 클램프, 콘덴서 & 칼럼용 **NEW** <L1>
 ■ Supplied by Bochem® in Germany

	Ea.	Price, ₩	
BC.5474 Clamp, Grip Capa. ϕ 30~65mm, Overall Length 150mm		48,500	



Bochem® 3-Way Lab-frame Foot, Tempered Cast Iron, ϕ 80×h41mm, for Lab-Frames **NEW**
 Suitable for ϕ 12mm Pipe & Rod, <Germany-made>, 프레임 다리(뚝)
 ■ ϕ 12mm의 규격 Pipe/Rod용에 적합, Frame 하부 고정용 다리로 3개의 Pipe/Rod를 동시에 연결 가능 <L1>
 * Assembly Lab Frame Foot of ϕ 12mm Pipe or Rod * Can Connect Max. 3 Rods at once

	Ea.	Price, ₩	
BC.5060 Holder Lab-frame Foot, ϕ 80×h41mm, Grip Capa. ϕ 12mm, 430g		36,110	

, Living



3M® Command™ Multipurpose Hook, Excellent Bonding, Damage-Free Hanging, Reusable **NEW**
 Ideal for Hang Home Décor, Cleaning Tools, and Other Small Items, 다용도 훅, 접착식

- 거실, 주방, 공부방 등 다양한 장소에서 주변정리에 도움을 줌
- 못질 자국이나 잔사가 남지 않음 - 혁신적인 테이프 기술력으로 강력하게 붙고, 표면 손상 없이 깨끗하게 떼어낼 수 있음
- * Can be Reused with Command® Refill Tapes * Easy to Apply and Remove
- * Excellent Bonding to Help Hold Items Securely
- * Hang Freely Without the Need for Tools or Other Equipment
- * Leaves Behind No Holes, Marks, or Sticky Residue



Round Hook, Limit Load 300g~1.8kg, 라운드 훅 <B4>

		Pk. Price, ₩	Cs. Price, ₩	
3M.02.17402	(1) Round Hook, Small , 22mm×40mm, Limit Load 300g, 3 Hooks	3ea 1,800	12pk	
3M.02.17401	(2) , Medium, 22mm×70mm, Limit Load 900g, 2 Hooks	2ea 1,800	12pk	
3M.02.17403	(3) , Large , 28mm×95mm, Limit Load 1.8kg, 1 Hooks	1ea 1,800	12pk	



Utility Hook, Limit Load 300g~1.8kg, 유틸리티 훅

		Pk. Price, ₩	Cs. Price, ₩	
3M.02.17502	(4) Utility Hook, Small , 16mm×30mm, Limit Load 300g, 3 Hooks	3ea 1,800	12pk	
3M.02.17501	(5) , Medium, 18mm×55mm, Limit Load 900g, 2 Hooks	2ea 1,800	12pk	
3M.02.17503	(6) , Large , 22mm×80mm, Limit Load 1.8kg, 1 Hooks	1ea 1,800	12pk	



Spare Accessories

		Pk. Price, ₩	Cs. Price, ₩	
3M.02.17024S	(7) Refill Tape, White, 16mm×46mm, 10 Sheets	10ea 1,320	20pk	
3M.02.17024M	(8) , 15mm×70mm, 6 Sheets	6ea 1,320	20pk	
3M.02.17024L	(9) , 20mm×95mm, 4 Sheets	4ea 1,530	12pk	



3M® Command™ Clear Cord Clips, Damage-Free Hanging, Reusable **NEW**
 Ideal for Keep Cords Organized, Easy to Apply and Remove, 전선 정리용 클립, 접착식

- 다양한 표면에 강력하게 부착되어 전선 등을 깔끔하게 정리
- 구멍을 남기거나, 잔사를 남기지 않고 깨끗하게 제거 가능 * Available Cord Thickness : (1) Aprx. 10mm (2) Aprx. 12mm
- * Come off Cleanly - No Holes, Marks, Sticky Residue or Stains * Holds Strongly and Removes Cleanly <B4>
- * Can be Reused with Command™ Refill Tapes

		Pk. Price, ₩	Cs. Price, ₩	
3M.02.17301	(1) Cord Clips, Clear, 33mm×18mm, 4 Clips + 4 Tapes, Medium	4ea 3,800	6pk	
3M.02.17303	(2) , 55mm×23mm, 2 Clips + 2 Tapes, Large	2ea 3,800	6pk	



3M® Command™ Holding Hook, Broom Gripper, Damage Free Hanging **NEW**
 Ideal for Storing Broom Sticks, Fast & Easy to Hang, 막대걸레 훅, 접착식

- 막대걸레를 깔끔하게 보관가능
- * Good for Neatly Storing Brooms * Weight Capacity : 1.8kg
- * Can be Reused with Command™ Refill Tapes <B4>

		Pk. Price, ₩	Cs. Price, ₩	
3M.02.17007	Hook, for Broom, 1 Hook + 2 Large Tapes	1ea 4,560	12pk	

Articles	Cat. No	Description
----------	---------	-------------



3M® Command™ Metal Hook for Bathroom, with Water Resistant Strips NEW

Ideal for Bathroom Organization, Ideal for Bathroom Organization, **메탈훅, 욕실용, 접착식**

- 습기가 많은 욕실에서도 강력하게 부착가능
- Made of Satin Nickel
- * Good for Hanging Towels, Robes, Loofahs, or Any Other Bath Stuffs
- * Sticks to a Variety of Surfaces Including Glass, Mirror, Tile, Fiberglass
- * Good Work on Wet, Hot and Humid Conditions
- * Strong & Versatile
- * Can be Reused with Command™ Refill Tapes

<B4>

Pk.	Price, ₩	Cs.	Price, ₩
1ea	8,420	12pk	



3M® Command™ Picture & Frame Hanging Strips, Holds Strongly, Removes Cleanly NEW

Ideal for Detachable Stuffs, Easy to Use, **부착테이프**

- 테이프와 찍찍이 테이프가 결합되어 주로 액자나 탈부착을 자주하는 상품을 부착하는데 편리함
- 벽면 손상 없이 깔끔하게 정리 정돈할 수 있음
- * Come off Cleanly - No Nail Holes, Cracked Plaster or Sticky Residue
- * No Tools Required - No Need to Nails and Screws

<B4>

Pk.	Price, ₩	Cs.	Price, ₩
8set	3,390	6pk	
6set	3,800	6pk	
10set	5,110	6pk	

DBL Carabiner, Aluminum Die Casting TAIWAN

(1) 원터치 타입, One Touch-type



(1) One Touch-type, 6×60 and 8×80mm

- 심플하고 범용성 높은 원터치 타입

<B3>

ORDER NO.	MODEL NO.	COLOR	PRICE, ₩ Ea.	규격(mm)	포장단위 Ea. / Pk.
(1) 0538-104	SCB-660SM	● 건메탈			
0538-105	SCB-660SR	● 레드	3,110	6×60	1 / 10
0538-106	SCB-660SG	● 골드			
0538-109	SCB-880SM	● 건메탈			
0538-110	SCB-880SR	● 레드	4,010	8×80	1 / 10
0538-111	SCB-880SG	● 골드			

(2) 락 타입, Lock-type



(2) Lock-type, 6×60 and 8×80mm

- 물건을 더 안전하게 보관할 수 있는 락 타입

ORDER NO.	MODEL NO.	COLOR	PRICE, ₩ Ea.	규격(mm)	포장단위 Ea. / Pk.
(2) 0538-114	SCB-660LM	● 건메탈			
0538-115	SCB-660LR	● 레드	4,560	6×60	1 / 10
0538-116	SCB-660LG	● 골드			
0538-119	SCB-880LM	● 건메탈			
0538-120	SCB-880LR	● 레드	5,010	8×80	1 / 10
0538-121	SCB-880LG	● 골드			



Carabiner with Knife, Lock-type CHINA

- 3가지 기능의 다양한 툴
- 녹슬지 않는 재질 선택으로 견고함

<B3>

Ea.	Price, ₩
0402-393	4,620



어스 클램프, Earth Clamp

다국적

NEW



- 튼튼한 강철 스프링, 우레탄 고무손잡이로 뛰어난 내구성
- 50SQ 전용 (KJC-350, KJC-550)

<B3>

ORDER NO.	MODEL NO.	PRICE, ₩ Ea.	포장단위 Ea. / Cs.
0424-931	KEL-50(검정)	2,560	1 / 50
0425-876	KEL-50(빨강)	2,560	1 / 50



어스클램프, Earth Clamp, 50A · 100A · 200A

다국적

NEW



50A
100A
200A

ST200A(A급)

- 점프선 제작 및 어스용

<B3>

ORDER NO.	규격	색상	PRICE, ₩ Ea.	포장단위 Ea. / Cs.
0206-505	50A	적색	590	1 / 500
0256-811	100A	적색	1,210	1 / 300
0206-507	200A	적색	1,390	1 / 100
0256-808	ST-200A(A급)	적색	2,820	1 / 100



스프링 클램프, Spring Clamp

GERMANY

NEW



◀ XM3

- 빠른 작업용 스프링 클램프
- Metal Based

<B3>

ORDER NO.	MODEL NO.	PRICE, ₩	압착기장(mm)	깊이(mm)
▶ 0503-498	XM3	1,480	25	32
0503-491	XM5	2,460	50	56
0503-492	XM7	4,810	75	84



C형 클램프, C-Clamp With Swivel Pad

GERMANY

NEW

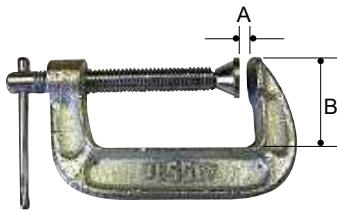

- DIY 등 가벼운 작업에 요하는 클램핑 최적
- 한번 회전으로 2번감김

<B3>

ORDER NO.	MODEL NO.	PRICE, ₩	압착범위 A(mm)	깊이 B(mm)
0503-735	CM15	2,950	38	38
0503-736	CM22	4,320	63	35
0503-737	CM30	5,490	75	45
0503-738	CM40	7,060	100	83



듀오 클램프, Duo-Clamp

GERMANY

NEW



- 한손 작업용 클램프
- 간단 스위치동작으로 압착, 벌림 가능

<B3>

ORDER NO.	MODEL NO.	PRICE, ₩	압착범위 A(mm)	깊이 B(mm)
0419-273	DUO30-8	32,450	300	85
0503-613	DUO65-8	39,600	600	85



밴드 클램프, Band Clamp

GERMANY

NEW



- 다양한 각도 조인트
- 액자, 테이블 조립 사용

<B3>

ORDER NO.	MODEL NO.	PRICE, ₩	압착길이(M)	끈넓이(mm)
0344-284	BAN700	26,960	7	25 × 1

Articles	Cat. No	Description
----------	---------	-------------

IRWIN 자동 압착 클램프, 이중조임, One-Handle Clamp, Duo-Tightening GERMANY

NEW



- 이중조임, 한손작업가능

<B3>

ORDER NO.	MODEL NO.	PRICE, ₩	압착범위 A(mm)	깊이 B(mm)
0503-694	EHZ30-2K	53,810	300	100

KDY C형 클램프, C-Clamp With Swivel Pad 다국적

NEW



- 다양한 두께의 구조물을 고정
- 부드러운 폴리머 레버 조작으로 안전함

<B3>

ORDER NO.	MODEL NO.	PRICE, ₩	규격
0111-905	4SP	18,980	100(4")
0264-783	K-6SP	7,260	150(6")
0522-755	K-9SP	10,500	225(9")
0264-784	K-11SP	11,870	275(11")
0457-170	K-14SP	15,990	350(14")
0264-785	K-18SP	21,560	450(18")
0140-944	24SP	56,860	605(24")

KDY 철판용 클램프, Sheet Metal Clamp 다국적

NEW



- 용접시 철판등 고정작업시 사용

<B3>

ORDER NO.	MODEL NO.	PRICE, ₩ Ea.	규격	포장단위 Ea. / Pk.
0264-782	K-8R	8,440	200(8")	1 / 4

KDY 용접용 클램프, Welding Clamp 다국적

NEW



- 철판 용접 작업 및 리벳팅 작업시 구조물을 고정시키기 위해 사용

<B3>

ORDER NO.	MODEL NO.	PRICE, ₩ Ea.	규격	포장단위 Ea. / Pk.
0264-780	K-9R	10,690	255(9")	1 / 6

IRWIN 목공용 킥 그립(강력형), One-Handed Bar Clamp 다국적

강력형

NEW



- 기존 킥 그립의 2.5배 압착력인 250kg으로 향상시켜 한손 작업에 편리하고 타사제품대비 탁월한 압착력, 강력한 압착, 벌림가능 등 목공, 접착작업향상에 획기적으로 기여할 수 있는 강력한 압착공구

<B3>

ORDER NO.	MODEL NO.	시리즈	PRICE, ₩	규격(mm)
0470-444	150HD	HD 클램프 강력형	41,420	150(6")
0478-486	300HD		46,610	300(12")
0470-453	450HD		51,780	450(18")
0470-454	600HD		56,970	600(24")
0470-455	910HD		64,210	910(36")
0470-456	1270HD		74,560	1270(50")

KDY 알루미늄 바이스/클램프, Aluminium Vise Clamp 다국적

NEW



회전 미니바이스

- 360° 회전기능 (회전조절 레버)
- 가볍고 간편하게 설치하여 사용가능
- Grip : 70mm, 무게 : 1.1kg



테이블 바이스

- 컴팩트한 규격과 경량화로 휴대가 간편
- 공예품, 전자부품, DIY 등 원하는 위치로 고정작업 용이
- Grip : 65mm, 무게 : 0.84kg

회전 미니바이스

<B3>

ORDER NO.	MODEL NO.	PRICE, ₩
0423-169	KTV-20	19,120

테이블 바이스

ORDER NO.	MODEL NO.	PRICE, ₩
0423-168	KTV-21	17,160

Articles

Cat. No

Description



(1) Refreshing, (2) Subtle



(3), (4) Refill

Febreze® Fabric Refresher Spray, Air Freshener, 370ml NEW

Ideal for Clothing, Shoes, Bags, Hat, etc, **페브리즈 섬유 탈취제**

■ **일상 냄새부터 세균 냄새까지 완벽 제거**

- * Use of Plant-derived Raw Materials
- * Effect of Removing Odor Molecules
- * Eliminates Odors due to 99.9% Antibacterial Effect

<B4>

- | | |
|-------------------|--|
| O3.F741866 | (1) Fabric Refresher Spray, 370ml, Refreshing |
| O3.F741873 | (2) , Subtle |
| O3.F113304 | (3) Fabric Refresher Refill, for Refreshing, 320ml |
| O3.F113106 | (4) , for Subtle, 320ml |

Ea.	Price, ₩
	5,480
	5,480
	4,980
	4,980



(1), (2) Vehicle-type



(3), (4) Restroom-type

Febreze® Stationary Deodorant, 2ml & 5.5ml NEW

For Vehicle- & Restroom-type, **실내 탈취제, 차량용 & 화장실용**

■ **악취 제거 및 재발 방지**

■ **오래 지속되는 상쾌함**

- * Remove Malodour
- * Relapse Prevention
- * Long-lasting Life (Vehicle-type : 30Days, Restroom-type : 45Days)

<B4>

- | | |
|-------------------|---|
| O3.F377010 | (1) Stationary Deodorant, Vehicle-type, 2ml, Lavender |
| O3.F377034 | (2) , Lime Orange |
| O3.F851657 | (3) , Restroom-type, 5.5ml, Refreshing Soapy |
| O3.F851664 | (4) , Subtle Lavender |

Ea.	Price, ₩
	5,360
	5,360
	6,880
	6,880



(1) for Refrigerator



(2) for Shoe Room

Deodorizer for Refrigerator & Shoe Rack, Odor Absorber, Eco-friendly, Compact Size

Ideal for Deodorization, Deodorant Capacity : max 1,000Lit, **탈취제, 냉장고 & 신발장용** NEW

■ **Made in Korea**

■ **유해물질 및 제품안정성 평가 완료**

■ **첨단소재인 첨착활성탄을 활용하여, 생활악취, 휘발성 유기화합물 등의 제거 성능을 극대화한 탈취제**

■ **빠른 시일 안에 자연으로 돌아갈 수 있는 친환경 소재 사용**

■ **탈취면적 : 1,000Lit**

■ **커버 제거방법에 따라 100%의 활성율로 1개월 사용하거나 50%의 활성율로 2개월 사용가능**

- * Remove the smell of food and fiber
- * Odor Absorber
- * Eco-friendly Material
- * Small Space Requirement

<B5>

- | | |
|-------------------|---|
| DH.Deo1001 | (1) Deodorant, for Refrigerator, 70×70×h100mm |
| DH.Deo1002 | (2) , for Shoe Room, 70×70×h100mm |

Ea.	Price, ₩
	7,400
	7,400



절취선
50% 사용시 (사용기간 : 2개월)
100% 사용시 (사용기간 : 1개월)

, Clean Room 크린룸 청소용품



Non-Woven Wiper, Class 10

AnyClean™ Non-Woven Wiper for Clean Room, 228×228mm, Class 10, 크린룸용 부직포와이퍼 NEW

■ **크린룸 Class 10에서 생산 & 포장된 크린룸 전용 와이퍼**

■ **침수성이 탁월하고 흡수력 및 닦임성이 뛰어나**

■ **거친면에 사용하더라도 보푸라기가 일어나지 않아 오염을 최소화함**

■ **Production and Packaging according to Class 10**

- * Low Particle & Lint, High Absorbency
- * Suitable for Wiping in Clean Room
- * Anti-static
- * Thickness : 0.336mm
- * Excellent Wiping Ability and Absorption Capacity

<L1>

- DH.Wip3011** Wiper, for Clean Room, Non-Woven, 228×228mm, 300sheets/Pk.

Pk.	Price, ₩
300sheets	16,120

Articles	Cat. No	Description
----------	---------	-------------



AnyClean™ Polyester Wiper for Clean Room, 228×228mm, 0.44 & 0.52mm-thick, Class 10
 Made of Polyester(100%), High Absorbency & Low Lint, 크린룸용 와이퍼, 정전기 방지 **NEW**

- 크린룸 Class 10에서 생산 & 포장된 크린룸 전용 와이퍼
- 크린룸 안의 장비 Cleaning 및 반도체 FAB, LCD, 생명공학 공정에 세척용으로 사용
- Production and Packaging according to Class 10
- * Suitable for Wiping in Clean Room
- * Excellent Chemical Resistance.
- Anti-static
- * Laser Cutting : Low Particle & Lint
- * Easily Wipes Up Liquid and Dust
- * 100sheets/Pk.

Specifications

Spec.	Model	(1) DH.Wip3001	(2) DH.Wip3002
Size / Thickness		228 ± 10mm / 0.52 ± 0.03mm	228 ± 10mm / 0.44 ± 0.03mm
Weight		Min 140g / m ²	Min 120g / m ²
Air Particle > 0.3 μ m		Max 80EA / SH	Max 200EA / SH
Absorbency		Min 340g / m ²	Min 320g / m ²
Absorption Speed		Max 8 sec	Max 8 sec
Fibrous Tissue		Double Knit	Interlock
Cat. No.		DH.Wip3001	DH.Wip3002
Price, Pk. ₩		16,420	15,290

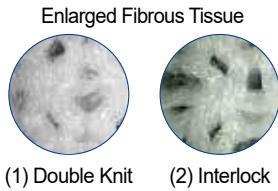

AnyClean™ Micro Denier Wiper for Clean Room, 228×228mm, 0.22~0.43mm-thick, Class 10
 Made of Polyester, Anti-Static, High Absorbency & Low Lint, 크린룸용 극세사 와이퍼, 정전기 방지 **NEW**

- 크린룸 Class 10에서 생산 & 포장된 크린룸 전용 와이퍼
- 크린룸 안의 장비 Cleaning 및 반도체 FAB, LCD, 생명공학 공정에 세척용으로 사용
- Production and Packaging according to Class 10
- * Laser Cutting : Low Particle & Lint
- * Suitable for Wiping in Clean Room
- * 100sheets/Pk.
- 초극세사 사용으로 흡수력, 뒹임성이 뛰어나
- 렌즈, 글라스 등 민감한 표면 세척에 사용
- * High Absorbency
- * Delicate, Sensitive Surfaces Cleaning without Scratches
- * Idea for Cleaning Sensitive Optical and Photomask Surfaces

Specifications

Spec.	Model	(1) DH.Wip3006	(2) DH.Wip3007	(3) DH.Wip3008
Size / Thickness		228 ± 10mm / 0.22 ± 0.03mm	228 ± 10mm / 0.43 ± 0.03mm	228 ± 10mm / 0.36 ± 0.03mm
Weight		Min 95g / m ²	Min 190g / m ²	Min 160g / m ²
Air Particle > 0.3 μ m		Max 70EA / SH	Max 100EA / SH	Max 100EA / SH
Absorbency		Max 150g / m ²	Min 350g / m ²	Min 240g / m ²
Absorption Speed		Max 7 sec	Max 12 sec	Max 10 sec
Fibrous Tissue		Plain Weave	Knit	Interlock
Cat. No.		DH.Wip3006	DH.Wip3007	DH.Wip3008
Price, Pk. ₩		20,730	33,290	19,670

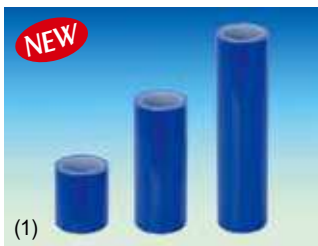
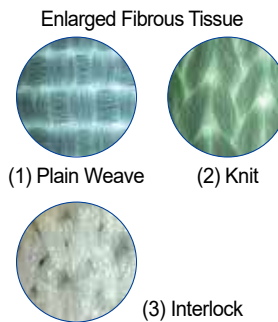

Sticky Roller & Handle, for Clean Room, Class 1000, w10~30cm, L18m, 50 μ m thick **NEW**
 Ideal for Removal Dust, High Adhesion, Lint-Free, 크린룸용 스티키 롤러 & 핸들

- Cleanroom 바닥이나 제품 및 의류의 먼지 제거용으로 매우 용이함
- Ideal for Removal Dust of Products, Clothes and Clean Room Floor.
- * Too Clean Because the Adhesives does not Adhere to the Object.
- * Easy to Peel with a Cutoff Line.

(1) Sticky Roller, PE, 10~30cm

- DH.Rol3001 Sticky Roller, Clean Room, w10cm×L18m, Blue
- DH.Rol3002 , w15cm×L18m, Blue
- DH.Rol3003 , w20cm×L18m, Blue
- DH.Rol3004 , w25cm×L18m, Blue
- DH.Rol3005 , w30cm×L18m, Blue

Ea.	Price, ₩
	2,030
	2,700
	4,360
	5,400
	4,980



(2) Roller Handle, with Plastic Handle, 10~30cm

- DH.Rol3011 Roller Handle, Clean Room, 10cm
- DH.Rol3012 , 15cm
- DH.Rol3013 , 20cm
- DH.Rol3014 , 25cm
- DH.Rol3015 , 30cm

Ea.	Price, ₩
	2,320
	2,640
	2,960
	5,230
	4,070

Articles

Cat. No

Description

NEW

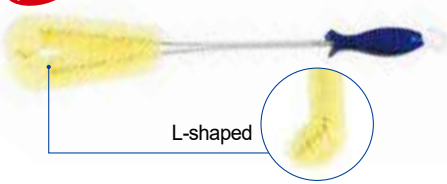

L-shaped Bottle PP Brush, with Styrole Resin Handle & Hook NEW
 Ideal for Reach Deep into Bottom of Bottles, Multi-use, L자형 다용도 병 세척솔 · 코너솔

- 닿기 힘든 병의 밑바닥과 코너부분을 깨끗하게 세척이 가능함
- * With L-shaped PP Bristle Ideal for Reach Deep into Bottom of Bottles
- * With Styrole Resin Handle & Hook
- * With Hook Ideal for Hanging to Dry and Store easily

<B1>

Ea. Price, ₩	4,740
--------------	-------

DH.Bru3006 Brush for Bottle, with L-shaped PP Bristle, Bristle L130×55mm, Total 400mm

NEW



Multi-use Nylon Brush-PP Scraper, with L-shaped Bristle & Hole in the PP Handle for Hanging NEW
 Ideal for Cleaning Corner & Other Gaps or Scrapping, L자형 다용도 나일론 브러쉬-PP스크래퍼

- L자형태의 솔로 손이 닿지 않아 청소가 힘든 구석구석을 깨끗하게 세척이 가능함
- 손잡이 부분에 스크래퍼가 있어 늘어붙은 이물질을 손쉽게 제거할 수 있음
- 손잡이 부분에 걸어서 보관할 수 있는 홀이 있어 건조하기에 편리함

- * L-shaped Nylon Bristle; Ideal for Cleaning Corner & Other Gaps easily
- * Scraper in PP Handle; Ideal for Removing Substance
- * With Hole in PP Handle; Ideal for Hanging to Dry the Bristle
- * Color will be Delivered Randomly. (Blue · Green · Pink)

<B1>

Ea. Price, ₩	5,360
--------------	-------

DH.Bru3007 Nylon Brush-PP Scraper, with L-shaped Bristle, Bristle L45×40mm, Total L175mm

NEW



Curved Handy Brush, with PP handle, Multipurpose, Overall Length 270mm NEW
 Suitable for Cleaning Bathroom, Quick & Easy Cleaning, 곡선형 다용도 브러쉬

- 골곡라인 솔로 구석구석 깨끗한 세척이 가능한 다용도 브러쉬
- Ideal for Cleaning Dirt from Tiles and Stained Floors

- * Color will be Delivered Randomly
- * Bristle w45×L100×h30mm, Handle L170mm

<B1>

Ea. Price, ₩	1,540
--------------	-------

DH.Bru3011 Handy Brush, Bristle w45×L100×h30mm, Overall 270mm

NEW



30×40×L250mm
▲ 패트 사각솔

65×40×L280mm
▲ 패트 주방솔

20×20×L230mm
▲ 동솔 (Copper)



다용도솔, Multiuse Brush

KOREA

<B3>

ORDER NO.	품명	MODEL NO.	PRICE, ₩
▶ 0481-939	패트 사각&재질솔	601067	1,650
▶ 0493-832	패트 주방솔	601074	2,010
▶ 0493-949	동솔 (Copper)	600145	3,640

NEW



(1) 다용도 바닥솔

(2) 패트 삼각 바닥솔

(3) 패트 센스 바닥솔



바닥솔, Floor Scraper Brush

KOREA

<B3>

- 타일바닥 목욕탕 등의 청소용에 적합

ORDER NO.	품명	MODEL NO.	PRICE, ₩	규격(mm)
(1) 0493-919	다용도 바닥솔	600176	4,320	120×60×750
(2) 0493-920	패트 삼각 바닥솔	601036	3,560	145×50×95
(3) 0493-922	패트 센스 바닥솔	601012	3,380	250×55×50

NEW



3M® Scotch® Toilet Cleaning Comfort Scrubber Brush, Extendable Handle NEW
 Ideal for Cleaning Bathroom, 길이 조절 화장실 브러쉬

- * Handle Length can be Adjusted
- * Easy to Clean into Hard to Reach Places such as Toilet Ceiling
- * Slip-Resistant and Extendable Handle
- * No need to Bend the Back for Cleaning
- * Easily Removes Hard Water Spots and Soap Scum

<B4>

Pk.	Price, ₩	Cs.	Price, ₩
1ea	9,660	6pk	

3M.02.2039 Toilet Scrub, Bristle L150×w100×h20mm, Total L500mm(Max. 640)

Articles	Cat. No	Description
----------	---------	-------------



NEW

Square Toilet Brush, with PP handle, Multi-use, Overall Length 420mm NEW
 Ideal for Cleaning Toilet, Durable & Long Lasting, PP 사각 변기용 브러쉬

- 탄력있고 촘촘한 와이드형 솔로 넓은면적도 꼼꼼한 세척이 가능한 브러쉬
- Suitable for Cleaning Hard Surfaces
- * Color will be Delivered Randomly
- * Bristle Length : w50×L120×h30mm, Handle 300mm

DH.Bru3012 Brush for Toilet, Square, Bristle w50×L120×h30mm, Overall 420mm

<B1>	
Ea.	Price, ₩
	1,540



NEW



변기솔, Toilet Brush

KOREA

		규격(mm)	<B3>
원형 변기솔 세트3호		130×100(통) / 76×370(솔)	
패트 바나나		460×55×40	
ORDER NO.	품명	MODEL NO.	PRICE, ₩
▶ 0493-905	원형 변기솔 세트3호	600091	2,560
▶ 0493-904	패트 바나나	601081	2,200

▲ 원형 변기솔 세트3호

▲ 패트 바나나



NEW

PP Toilet Bowl Brush Set, with Easy Grip PP Handle, Bristle L90×φ85mm, Overall 400mm
 Ideal for Cleaning Toilet, PP 변기용 브러쉬 세트 NEW

- 360도 모든면이 사용가능한 브러쉬로 위생적인 솔과 보관케이스가 함께 구성
- The Holder Serves as a Cup to Catch Any Excess Liquids from the Brush
- * Ideal for Cleaning Toilet
- * Color will be Delivered Randomly (Blue/Green/Orange)
- * Keep Toilet Clean and Free from Stains and Residue
- * Bristle L90×φ85mm / Case Size : w130×h135mm

DH.Bru3013 Brush Bowl Set, for Toilet, Bristle L90×φ85mm, Overall 400mm

<B1>	
Ea.	Price, ₩
	3,060



NEW

Spray Type Handy Brush · Wiper, with PET Spray Bottle & Handle, Convenient NEW
 Ideal for Cleaning Window & Glass, Multifunction, 스프레이 창유리닦이용 핸디 브러쉬 · 와이퍼

- 스프레이 & 와이퍼 일체형; 세정제 분사 후 바로 물방울 자국 청소 가능
- Suitable for Cleaning Windows, Bathtubs, Mirrors, Bathroom Tiles, Smooth Surfaces, &etc.
- * Easy to Remove the Dirt on the Glass * No Water Marks Left
- * Comes with a Spray Bottle, Use more Convenient
- * Do Not Need to Prepare Another Detergent when Wipe the Glass
- * Grey and White Color will be Delivered Randomly
- * Material - Silicone Brush + PP Frame + PET Spray Bottle

DH.Bru3014 Handy Brush · Wiper, Spray Type, w255×30×L240mm

<B1>	
Ea.	Price, ₩
	3,060

Articles

Cat. No

Description



Wisd Facial Tissue, 100% Virgin Natural Pulp, 2-Layer, 210×200mm NEW
 Non-Fluorescence · Fragrance · Dye, 250 Sheets, 미용티슈

- **Made in Korea**
- **100% 천연펄프, 무향·무염크·무형광증백제**
- * Made of 100% Virgin Natural Pulp * Softly Comfort Skin
- * Non-Fluorescence · Non-Fragrance · Non-Dye * 2-Layer

※ **Cs. 운임 착불** <B4>

Pk.	Price,₩	Cs.	Price,₩
3ea	4,260	8pk	31,510

DH.Tis901 Facial Tissue, Soft Comforts Skin, 210×200mm, 250 Sheets/Ea



Wisd Popular Kitchen Towel, Sheet- & Roll-type, Low-Lint, Non-Fluorescence, Non-Toxic NEW
 Made of 100% Virgin Natural Pulp, 2-Layer, 범용 키친타올, 시트타입 & 롤 타입

- **Made in Korea**
- **무형광의 100% 천연펄프로 위생적이며 안심하고 사용 가능**
- **Low-Lint, Excellent Tear Resistance**
- * Multi-Use in Household · Industry · Laboratory

※ **Cs. 운임 착불** <B4>

Pk.	Price,₩	Cs.	Price,₩
130sheet	1,320	12pk	14,550

(1) Sheet-type, 215×213mm, 130매

DH.Tis906 Kitchen Paper Towel, Sheet-type, 2-Layer, 130매

(2) Roll-type, 114×216mm, 130매/롤×6

DH.Tis908 Kitchen Paper Towel, Roll-type, 2-Layer, 130매/롤×6

Pk.	Price,₩	Cs.	Price,₩
6roll	3,680	4pk	13,590

Say+® General Purpose Hand Paper Towel & ABS Dispenser, 2 Layer, 213×213mm & 213×200mm
 With Embossing Texture, Non-Fluorescence Pulp, Soft, White Color, 다용도 핸드타올 & 분주기



- **Made in Korea**
- **Non-Fluorescence, Non-Toxic** ■ **Non-Fluorescence White Pulp**
- **Folded General-Purpose Paper Towel for Cleaning, Drying and Multi-use**
- **Excellent Tear Resistance**

(1) 2-Layers Hand Paper Towel made of Non-Fluorescence Pulp NEW

- * Thick & Soft with Excellent Absorbency

K18.KJH5002 Hand Paper Towel, 2-Layers, 213×200mm

※ **Cs. 운임 착불** <B4>

Pk.	Price,₩	Cs.	Price,₩
100sheet	560	50pk	25,910

(2) 2-Layers Hand Paper Towel with Excellent Tear Resistance

- * Soft, Excellent Tear Resistance and Absorbency

K18.KJH50012 Hand Paper Towel, 2-Layers, 213×200mm

Pk.	Price,₩	Cs.	Price,₩
100sheet	560	50pk	25,910

(3) ABS Dispenser for Hand Paper Towel, Easy to Installation

- * ABS(Acrylonitrile-Butadiene-Styrene Resin) Material

K18.HTD200 Dispenser, Hand Paper Towel, ABS, 253×340×118mm

Pk.	Price,₩	Cs.	Price,₩
1ea	6,680	10pk	61,750



Wisd Toilet Scroll Tissue, 3-Layer, Strong & Absorbent, 30Roll, 95mm×L30m NEW
 Embossing Texture, Soft, Non-Fluorescence/-Toxic, 100% Natural Pulp, 두루마리 화장지, 비데겸용, 3겹

- **Made in Korea**
- **100% 천연펄프, 3겹, 비데 겸용 화장지** ■ **부드럽고 물에 잘녹음**
- **무형광·무향료·무염크** ■ **에어쿠션 엠보싱으로 더 깨끗한 마무리**
- **Toilet Paper for Bidet**

- * Good Tear Resistance & Absorbency
- * Non-Fluorescence/-Fragrance/-Dye

<B4>

Pk.	Price,₩	Cs.	Price,₩
30Roll	11,190	3pk	31,080

DH.Tis904 Toilet Paper Towel, 3-Layers, 30Roll, 95mm×L30m

Articles	Cat. No	Description
----------	---------	-------------



Soom™ 100 Sheets Wet Tissue, Rayon & Polyester, Thick & Soft, Purified Water, 180×175mm NEW
 Chamomile Extract, Dispenser Bag-type With On-Off Cap, 100매 프리미엄 물티슈

- 10단계 초순수 정제수로 피부저자극, 도톰하고 부드러운 원단
- * Made with 10-step Purified Water * Skin Hypoallergenic Test Completed
- * Chamomile Extract * Free-Harmful Ingredients
- * Thick & Soft * Made of Rayon & Polyester

<B4>

K18.KJWT12 Wet Tissue, Soom™, 180×175mm, 100 Sheets/Pk

Pk.	Price, ₩	Cs.	Price, ₩
100sheet	1,000	25pk	22,920



Wisd. 80 Sheets Soft Wet Tissue, Rayon & Polyester, Clean & Soft, Purified Water, 140×175mm
 Chamomile Extract, Free-Harmful Ingredients, 80매 소프트 물티슈 NEW

- 10단계 초정밀 여과, 정수 시스템과 UV 자외선 살균으로 피부에 자극이 적음
- 카모마일 추출물 함유로 순하고 부드러운 프리미엄 물티슈
- * Made with 10-step Purified Water * Contains Chamomile Extract
- * Clean and Soft * Free-Harmful Ingredients
- * Dispenser Bag-type with On-Off Type * Made of Rayon & polyester

<B4>

DH.Wet901 Soft Wet Tissue, 140×175mm, 80 Sheets/Pk

Pk.	Price, ₩	Cs.	Price, ₩
80sheet	910	25pk	21,000

Articles

Cat. No

Description

NEW

Medicaluse



3M® Cavilon™ No-Rinse Skin Cleanser Sprayer, pH Balanced, Hypoallergenic, 236ml, *Medicaluse*
Daily Incontinence Skin Care, Control Odor, 노-린스 스킨 클렌저 스프레이 **NEW**

- 자극 없는 pH밸런스 스킨 클렌저; 실금 및 당뇨 환자의 소변, 대변 및 체액을 피부 자극없이 제거, 물로 따로 헹구지 않아도됨, 보습성 유지
- **No-Rinse Solution that Gently Cleans Skin without Irritation**
- **Protecting at-Risk Skin from Damage Associated with incontinence**
- **Using for Diabetic Foot Care, Dry Skin, Maceration, Irritation around a Peri-tube Opening, and Pressure Ulcers**
- * Trigger Sprayer for Ease of Use * Ideal for Cleaning All Body Fluid Types Including Urine and Stool
- * Can be Used on Both Intact and Irritated Skin * Helps to Control Odor for Improved Environment and Patient Well-Being <M4>
- * Contains Ingredients That Help Moisturize and Condition the Skin as it Cleans

3M.07.3380 No-Rinse Skin Cleanser, Spray-type, 236ml

Ea.	Price, ₩	Cs.	Price, ₩
	13,760	12ea	160,060

NEW



Yuhan® Portable Mouthwash with Peach, 250 & 750ml, 구강청결제, 가글용 **NEW**

- 타르색소, 에탄올 무첨가 ■ 입냄새 제거 ■ 불소막을 생성하여 충치 예방에 효과적인
- * Contains Isopropylmethylphenol (IPMP) * Fluorine Film Formation due to Sodium Fluoride
- * Contains Baking Soda and Xylitol

Y2.529581 Portable Mouthwash, with Peach, 250ml
Y2.529598 , 750ml

Ea.	Price, ₩
	2,940
	6,120

NEW

NEW



Systema® Toothpaste for Oral Care, 120g, 시스테마® 치약 **NEW**

- (1) 구취 제거용, (2)치석 제거용
- * Breath Care : Teeth/Gum Discoloration Prevention with TXA
- * Tartar Advanced : Protect against Tartar build up with TSPP

L9.616757 (1) Toothpaste, Breath Care, 120g
L9.616771 (2) , Tartar Advanced, 120g

Ea.	Price, ₩	Pk.	Price, ₩
	2,300	3ea	6,380
	2,300	3ea	6,380

NEW

(1) 연황색

(2) 연분홍



LG Household & Healthcare® Antibacterial Soap, Dermatology Tested, 140g × 3 **NEW**
LG 알뜨랑 오리지널 향균비누, 연황 & 연분홍

- 단단하고 잘 물러지지 않는 비누
- * Moisturising Ingredients and Pine Fragrance
- * Protection against Bacteria.

O3.578108 (1) Antibacterial Soap, Light-Yellow, 140g × 3ea
O3.578092 (2) , Light-Pink , 140g × 3ea

Pk.	Price, ₩
3ea	6,380
3ea	6,380

NEW

(1)



Foaming-type Hand Soap, 250ml **NEW**
With Antimicrobial Pump Head, Antibacterial Cleanser, 아이깨끗해 포밍형 손 세정 및 소독제

- 피부 테스트 완료 ■ 향균 99.9% 효과
- 풍성한 거품을 제공하는 포밍형 세정제
- * Remove Harmful Bacteria due to Strong Antibacterial Effect
- * Add Aroma * 1ml per serving

<B4>

NEW

(2)



Scent	(1) Bottle-type 250ml				(2) Refill-type 200ml			
	Cat. No.	Ea. Price, ₩	Cs.	Price, ₩	Cat. No.	Ea. Price, ₩	Cs.	Price, ₩
Lemon	L9.5009610	4,820	18ea	80,200	L9.5610809	3,440	24ea	76,380
Powder Scent	L9.5614258	4,820	18ea	80,200	L9.5614265	3,440	24ea	76,380
Moisturizing	L9.5613374	4,820	18ea	80,200	L9.5613381	3,440	24ea	76,380

Articles	Cat. No	Description
----------	---------	-------------



Aekyung® Perfume Bodywash, for Body Care, 1,200ml NEW
 With Perfume Sticky Bubble for More Fragrant, 샤워메이트 바디워시

- 자연에서 유래한 섬세하고 오래 지속되는 향 ■ 풍성하고 크림 같은 거품으로 피부를 촉촉하고 깨끗하게 유지
 - * Total Body Care * Delicate and Long-Lasting Scent * Creamy Bubble make Skin Clean and Moist.
- | O3.A307458 | (1) | Perfume Bodywash, 1,200ml, Clean-Cotton | | Ea. | Price, ₩ |
|-------------------|-----|---|--|-----|----------|
| O3.A307465 | (2) | , Citron | | | 7,000 |
| O3.A307472 | (3) | , Cranberry | | | 7,000 |



Aekyung® Hair Clinic Shampoo and Conditioner, 750ml NEW
 With Argan Oil, Jojoba Oil, Avocado, Herb, 케라시스 샴푸 & 컨디셔너

- 손상된 모발을 건강하고 윤기 있는 머릿결로 관리
 - * Nourish Hair with Low Molecular Vegetable Protein and Triple Oil.
 - * Add Luster to the Hair with Ceramide Ingredients * Prevent Hair Damage with Swiss Alpine Herb Extract.
- | O3.A285602 | (1) | Hair Clinic Shampoo, 750ml | | Ea. | Price, ₩ |
|-------------------|-----|--------------------------------|--|-----|----------|
| O3.A285626 | (2) | Hair Clinic Conditioner, 750ml | | | 8,280 |
| | | | | | 8,280 |



Oxy® Hand Sanitizer, Liquid Spray, 70% Ethyl Alcohol, 30ml, 휴대용 손 소독제 NEW

- 간편하게 휴대가능하며 물과 비누 없이 간단히 뿌려서 살균소독
 - * Prevent Various Bacteria and Viruses such as Influenza * KP Certification
 - * Residue-free and Fast Drying due to High Volatility
- | Y2.514273 | | Hand Sanitizer, Liquid Spray, 30ml | | Ea. | Price, ₩ |
|------------------|--|------------------------------------|--|-----|----------|
| | | | | | 2,300 |

, Detergents/Disinfecting-Household 생활 세제



Dishwashing Liquid Detergent, for Fruits · Vegetables · Tableware, 친환경 주방세제 NEW

- 화학성분이 무첨가된 복합세정시스템으로 기름기를 깔끔하게 제거
 - * Class-one Detergent : Vegetable washable, Kitchen ware Washable * Oil Removal & Skin Protection Formula
- | (1) Yuhan® Omeal, 700g | | | | Ea. | Price, ₩ |
|---|--|---|--|-----|------------|
| Y2.519551 | | Dishwashing Liquid Detergent, with Oatmeal, 690ml, 700g | | | 700g 3,920 |
| (2) LION® Green Tangerine Scent, 1kg | | | | Ea. | Price, ₩ |
| L9.623632 | | Dishwashing Liquid Detergent, 970ml, 1kg | | | 1kg 4,200 |



General Purpose Auto-washer Detergent, for Glass & Plastic-wares, 20kg, pH9.0 ± 1 NEW
 Ideal for SS, Glass, Plastic, Porcelain, 자동 식기 세척기용 범용 세제

- * Standard Volume : 18Lit.(20kg) * Potassium Hydroxide Detergent
 - * Use of Concentrate-type : Add Concentration Liquid to Empty Barrel(18Lit.) and Fill It with Water.
 - * High-enriched, Excellent Cleaning Power and High-Quality Detergent
- | DH.WGW02010 | (1) | Potassium Hydroxide Liquid Cleaning Detergent, 18Lit | | Ea. | Price, ₩ |
|--------------------|-----|--|--|-----|----------|
| DH.WGW02016 | (2) | , Concentrate, 1Lit | | | 30,860 |
| | | | | | 17,430 |



General Purpose Auto-washer Nonionic Surfactant Rinse, 20kg, pH6.9 ± 1 NEW
 Ideal for SS, Glass, Plastic, Porcelain, 자동 식기 세척기용 범용 린스

- * Standard Volume : 18Lit(20kg) * Nonionic Surfactant Liquid Rinse
 - * Use of Concentrate-type : Add Concentration Liquid to Empty Barrel(18Lit.) and Fill It with Water.
 - * Remove Residual Detergents and Accelerate Drying
- | DH.WGW02011 | (1) | Nonionic Surfactant Liquid Rinse, 18Lit | | Ea. | Price, ₩ |
|--------------------|-----|---|--|-----|----------|
| DH.WGW02017 | (2) | , Concentrate, 1Lit | | | 30,860 |
| | | | | | 17,430 |

Articles

Cat. No

Description

세탁망, Smart Wash Bag

KOREA

- 미세망으로 된 세탁망이 세탁물 원형 보호
- 지퍼에 안전 커버 부착
- 폴리에스테르 100%

<B3>

NEW



▶ 여성속옷용(상)

▶ 일반의류

ORDER NO.	품명	MODEL NO.	PRICE, ₩	규격(mm)	타입
▶ 0493-867		144380	4,180	130×180	여성속옷용(상)
▶ 0493-869	스마트	144410	3,920	직경 360	속옷용(하)
▶ 0493-870	세탁망	144403	3,730	270×400	와이셔츠
▶ 0493-868		144458	4,090	직경 450	일반의류

NEW



Yuhan® Oxygen Based Detergent, pH 8.5 and pH 11, 다용도 세제, 인체무해 천연원료

NEW

- (1)과탄산소다 : 표백에서 세탁조 청소까지 다양한 살균 표백, 얼룩제거용
- (2), (3) 베이킹소다 : 과일 세척, 세탁, 욕실 청소 외 다양하게 사용. 세척과 탈취에 탁월함.
- * Oxygen-Based Sterilization Bleach 100%, without Additives
- * Removes 99.9% of Harmful Bacteria

<B4>

Y2.551575	(1) Detergent, Sodium Percarbonat, Resealable Bag, pH 11, 1kg	6,240
Y2.520892	(2) , Baking Soda, Resealable Bag, pH 8.5, 2.1kg	5,600
Y2.000228	(3) , Water-resistant Container, pH 8.5, 400g	2,560

Ea.	Price, ₩
	6,240
	5,600
	2,560

NEW



1Lit

Aekyung® Neutral Detergent for Fabric Care, 1Lit, pH7.0

NEW

Ideal for Wool · Silk · Cotton · Linen, Acquired Official Wool Mark, 울 삼푸, 중성세제

- 알칼리에 손상될 수 있는 섬유를 케어해주는 올마크 인증받은 중성세제
- Wool-Mark Certified by APPAREL CARE®
- * Used for Hand-washing, Washing Machines
- * Keeping Clothes with Fabric Protection Effect
- * Hypoallergic Cleaning Substances

<B4>

O3.A878996 Neutral Detergent for Fabric Care, 1Lit

Ea.	Price, ₩
	4,840

NEW



3Lit

Pigeon® Act'z Liquid Detergent, General- & Antibac-type 3Lit

NEW

Ideal for Cotton · Polyester · Rayon · Nylon · Acrylic, No Detergent Residue, 액츠 액상 세탁세제

- 냉수에도 사용 가능한 액상형 강력 세제
- Added Natural Antimicrobial Substance
- * Powerful Washing
- * Enhancement to Prevent Recontamination.
- * 100% Soluble in Cold Water
- * High-performance Bleaching and Color Protection

<B4>

O3.P880283 Detergent, Liquid, General-type, 3Lit
O3.P880284 , Antibac-type, 3Lit

Ea.	Price, ₩	Cs.	Price, ₩
	10,820	4ea	43,280
	10,860	4ea	43,400

NEW



1Lit

Oxy® Liquid Oxygen Bleaching Agent for Clothes, Stain Remover, 1Lit

NEW

For White and Coloured Clothes, Bleaching & Sterilization, 천 표백 세탁제, 산소계 액상

- 빠른 얼룩제거, 살균, 표백 기능
- * Excellent Effect in 30 Seconds
- * without Chlorine Bleach
- * Dermatology Tested
- * Removing 99.9% of Germ

<B4>

O3.001064 Liquid Oxygen Bleaching Agent for Clothes, 1Lit

Ea.	Price, ₩
	11,980

NEW



2.5Lit

Pigeon® Fabric Softener, Pink Rose Aroma, Dermatology Tested, 2.5Lit

NEW

With Flower Essence, Deodorizing effect, Prevention of fine dust, Non-stimulation, 피죤 섬유 유연제, 핑크 로즈향

- 오래가고 풍부한 향기, 안전한 성분
- * Ideal for Clothing, Textiles, Footwear
- * Pink Rose Scent from Natural Flower Essence
- * Not added Hazardous Substances
- * Do not Mix with Detergent Bleach

<B4>

O3.P168093 Fabric Softener, 2.5Lit

Ea.	Price, ₩
	3,580

NEW



740ml

3M® Glass Cleaning Detergent, Spray-type, Fouling Resistant, Anti-Fogging, 740ml

NEW

Ideal for Remove Water-stain · Grime · Dust, Quick Drying, Long Lasting, 유리세정 보호제

- 친수성 보호막으로 습기를 방지하고, 자국을 빠르고 쉽게 세정함
- 유리표면 코팅하여 우수한 내오염성과 높은 투명도 구현
- * Reduce Fogging on Windows and Mirror with Repeated Use

<B4>

3M.08.1011 Detergent, Spray, for Glass, 740ml

Ea.	Price, ₩	Cs.	Price, ₩
	2,950	12ea	

Articles

Cat. No

Description



Yuhan® Tile/Silicone Cleaning Detergent, Liquid-type & Gel-type NEW
 For Easy and Effective Cleaning, Ideal for Remove Old Stains, 청소용 세제, 타일/실리콘 묵은 때 제거용

■ 살균 표백, 세척 ■ 뿌려 쓰는 노즐 타입
 * Use for : Surface of Tile, Cooking Table, Bath, Sink, Toilet, Oven, Shower Booth, Wastebasket <B4>
 * Ideal for Remove Old Stains, Silicone mold * Easy to Use : Spread, Wait(2~3min), Wipe off

Ea.	Price, ₩
	4,010
	3,940

Y2.508098 (1) Detergent, Liquid-type, for Tile & Silicone, 755ml
Y2.507930 (2) , Gel-type , for Tile & Silicone, 1Lit



3M® Bathroom Cleaning Detergent, Prevent Stain, Foam-type, Subacidity, 740ml NEW
 Ideal for Cleaning Toilet · Tile · Washbin, 욕실청소용 세정제

■ 사용 후 얇은 피막이 형성되어 피든 때 생성을 억제함 ■ 물때, 화장실 오염 제거에 탁월 <B4>
 * Easy to Use & Linsing * Suitable for Removal Contamination in Bathroom

Ea.	Price, ₩	Cs.	Price, ₩
	4,070	12ea	

3M.08.1012 Detergent, Spray, for Bathroom, 740ml



Yuhanrox® Bathroom Cleaning Spray Detergent, Foam-type, 500ml NEW
 Ideal for Bathroom Floor · Tile · Washbasin, 욕실청소용 살균세정제

■ 곱팡이와 각종 세균 및 냄새제거 ■ 간편한 스프레이 타입 * Powerful Sterilization and Cleansing <B4>
 * Abundant Foam * Easy Rinsing * Smell the Scent of Flowers

Ea.	Price, ₩	Cs.	Price, ₩
	6,330	10ea	61,500

Y2.507763 Detergent, Spray, Cleaning, for Bathroom, 500ml



Oxy® Toilet Bowl Cleaner, Solid- & Bottle-Type NEW
 Excellent Toilet Cleaning, Refreshing Blue, 청크린 변기 세정제

■ 세정 효과와 상쾌함을 느끼게 하는 파란 물로 변기는 항상 청결하게 유지 <B4>
 * Excellent Cleaning Effect * Refreshing Blue * Effect Lasts about 40 Days Each

Pk.	Price, ₩
4ea	3,820
2ea	5,860

O3.000173 (1) Toilet Bowl Cleaner, Solid-Type, 40g
O3.505067 (2) , Bottle-Type, 180g



BullsOne® Article Disinfectant Spray, HOCLER, 99.9% Remove of Germ, 500ml NEW
 Ideal for Smart Phone, Indoor, Vehicle, Dermatology Tested, 물품 살균소독 스프레이

■ 냄새 원인균 포함 51종 세균&바이러스 99.9% 강력제거 <B4>
 * Harmless to Humans * KTC, KITOX, KTR, KTC Certified
 * GRAS Certified (Generally Recognized as Safe) : FDA, USDA
 * Formula : HClO(Hypochlorous Acid), Water

Ea.	Price, ₩
	6,380

O3.B214959 Disinfectant Spray, HOCLER, 500ml



Yuhan® Disinfectant Cleaning Detergent, 1 & 2Lit NEW
 유한락스® 살균세척제

■ 살균, 악취 제거, 표백 및 바이러스를 99.9% 제거 <B4>
 ■ Ideal for Laboratories, Hospitals, etc.
 * Effective Sterilization, Disinfection and Removal of Bad Smell

Ea.	Price, ₩	Cs.	Price, ₩
	2,480	12ea	27,500
	4,820	6ea	26,740

Y2.1001 Disinfectant Cleaning Detergent, 1Lit
Y2.1002 , 2Lit

Articles

Cat. No

Description



NEW

Cleanwrap® Disposable Scrubber, Roll-type, Thick Embossing Fabric, 230×225mm NEW
Antibacterial Treatment, Convenient Use, 50 Sheets, 일회용 수세미

■ 두꺼운 엠보싱 원단으로 하루 한장 편리한 사용

- * Thick Embossing Fabric
- * Meltblown Material
- * Powerful Removal of Scraps
- * Take One Piece at a Time
- * Antibacterial Test Completed
- * Convenient Use

<B4>

C10.512 Disposable Scrubber, Roll-Type, 230×225mm, 50 Sheets

Pk.	Price, ₩	Cs.	Price, ₩
50sheets	3,420	15pk	47,360



NEW

Cleanwrap® Cellulose Scrubber, Natural Cellulose, Long-term Use, 115×90×23mm NEW
Antibacterial Treatment, Rich Foam, Excellent Design, SF-Mark, 셀룰로즈 수세미

■ 부드러운 셀룰로즈와 강력한 나일론의 이중기능

- * SF-Mark : Sanitary Processing Marks for Antibacterial and Odo
- * Natural Cellulose
- * Excellent Design for Cleaning Corners
- * Rich foam
- * Antibacterial Test Completed
- * Double Function of Rough Soft Cellulose & Rough Nylon

<B4>

C10.515 Cellulose Scrubber, 115×90×23mm

Pk.	Price, ₩	Cs.	Price, ₩
1ea	1,470	100pk	135,800



NEW

Cleanwrap® Sponge Scrubber, Nylon & Sponge, Double Function, Fast Drying NEW
Long-term Use, Powerful Removal, 스펀지 수세미

■ 찌꺼기를 강력제거하고 오래 사용 가능해 경제적

- * Double Function of Rough Nylon & Soft Sponge
- * Rich Bubbles with Less Detergent
- * Powerful Removal of Scraps
- * Economical for Long-term Use

<B4>

C10.517 (1) Sponge Scrubber, Large, 90×150×32mm

C10.518 (2) , Small, 75×115×30mm

Pk.	Price, ₩	Cs.	Price, ₩
1ea	670	100pk	60,200
1ea	410	100pk	36,400



(2)

, Dusters 먼지청소



NEW

3M® Scotch® Multi-purpose Duster, Ergonomic Design, with ABS Handle, Overall L285mm NEW
Ideal for Remove Dirt in Grout, Easy to Use, 다용도 먼지떨이개

■ 먼지 흡착 특수오일 코팅으로 틈새 먼지 청소 가능, 교체형 리필로 위생적인 청소 및 청소도구 관리 가능

- * Material : Head-Polyolefine+Polyester, Handle-ABS
- * Suitable for Cleaning Ceilings, Wall, Shelves, Key-board, and Furniture
- * Handle Color will be Delivered Randomly

<B4>

3M.02.2045 Duster, Multi-use, Bristle w80×160mm, Overall L285mm

3M.02.2046 , Refill, Bristle w80×160mm

Pk.	Price, ₩	Cs.	Price, ₩
1ea	2,970	8pk	
2ea	3,250	8pk	



NEW

3M® Scotch® Car Duster, PP Non-slip Extendable Handle, Overall L67cm NEW
Ideal for Remove Stubborn Dirt without Scratching, Reusable, 차량용 먼지떨이개

■ 초극세사 미세울 조직으로 차량의 미세먼지와 기름때를 흠집없이 제거

- * Material : Superfine Fibre, ABS, PP
- * 4 Steps Adjustable Length : 67cm~79cm
- * Duster Can be Easily Detached from the Handle for Washing

<B4>

3M.02.2047 Duster, for Car, Pad w150×L420mm, Overall L67(max.79)cm, 446g

Ea.	Price, ₩
	21,030

Articles	Cat. No	Description
----------	---------	-------------



LOTTE® e-Life™ Tape Cleaner, High Adhesion, I · T type, 100 & 160mm, L8 & 10m NEW
 With Case & Hanging Loop, Ideal for Removal Dust · Hair · Pet Hair · etc., Easy to Peel, **테이프클리너**

■ **Made in Korea**

- * 먼지, 머리카락 등을 간편하고 손쉽게 제거할 수 있음
- * Maintains Excellent Adhesion, Rip a Piece Easy to Use
- * Easy Use for Clothing & Floors * Allowing Quick & Comfortable Cleaning

<B3>

L5.601	(1) Tape Cleaner, I-type, 100mm × 8m
L5.602	(2) , T-type, 160mm × 10m
L5.606	(3) Refill, I-type, 100mm × 8m × 3ea
L5.607	(4) , T-type, 160mm × 10m × 3ea

Pk.	Price, ₩	Cs.	Price, ₩
1ea	3,720	20pk	68,840
1ea	7,590	10pk	70,160
3ea	5,370	20pk	99,280
3ea	9,160	20pk	169,440

, Mops/Brooms 막대걸레/빗자루



▲ 초극세사 백마포

▲ 초극세사 청마포

▲ 나사형 마포대



마포걸레 & 봉, Floor Mop

KOREA

■ 마포대와 걸레가 분리되어 위생적

<B3>

ORDER NO.	품명	MODEL NO.	PRICE, ₩	규격(mm)
▶ 0493-962	초극세사 백마포	470052	3,300	320 × 170 × 40
▶ 0493-960	초극세사 청마포	470076	3,640	320 × 170 × 40
▶ 0493-945	나사형 마포대	491910	5,000	190 × 1,450



▲ 마포대 짤순이

▲ 파워 짤순이(분체도장)



마포걸레 짤순이, Mop Squeezer

KOREA

■ "마포대 짤순이"는 바닥이 막혀있어 어느 곳에서든 세탁 가능

<B3>

ORDER NO.	품명	MODEL NO.	PRICE, ₩	규격(mm)
▶ 0493-830	마포대 짤순이	480037	41,760	390 × 290 × 310
▶ 0493-829	파워 짤순이(분체도장)	479000	52,730	425 × 245 × 220



NEW

285mm

Broom & Dustpan-set, Bristle w285mm, PP Handle with Hanging Hole NEW
 Ideal for Office or Home use, Polyester Bristle, **빗자루 & 쓰레받이 세트**

■ **Made in Korea**

- * PP Handle with Hanging Hole - Excellent Utilization of Space
- * Rubber Lip-type Dustpan - Excellent Contact with Floor

<B1>

DH.Bro3003 Broom & Dustpan-set, Bristle 285 × h90mm, Overall 350mm

Ea.	Price, ₩
	7,640

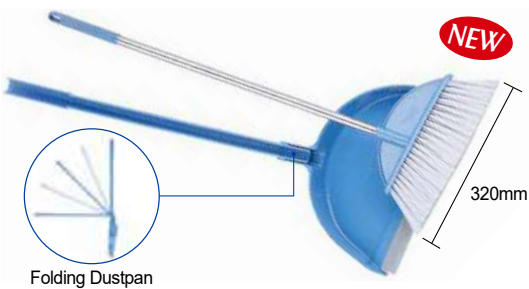

NEW

Folding Dustpan

320mm

Broom & Folding Dustpan-set, Bristle w320mm, PP Handle, Angled Dustpan, L72cm NEW
 Good for both Indoor & Outdoor, Compact Storage, **빗자루와 접이식 쓰레받이 세트** NEW

■ **Made in Korea**

- **쓰레받이 각도 조절 가능, 일체형으로 보관 용이, 특수 가공된 모로 수명이 길고 잘 빠지지 않음.**
- * Strong PP Handle with Hanging Hole / PVC Bristle
- * Easy to use with Angled Dustpan
- * No Need to Bend the Back for Cleaning
- * Convenient Step of Folding Dustpan & Broom, Available Vertical Keep

<B1>

DH.Bro3004 Broom & Folding Dustpan-set, Bristle 320 × h65mm, Overall 720mm |

Ea.	Price, ₩
	7,640



NEW

(1) 솔비

(2) 옥외용 패트비



정밀 마당 빗자루, Detailed Broom

KOREA

<B3>

ORDER NO.	품명	MODEL NO.	PRICE, ₩	규격(mm) 가로×세로×높이
(1) 0493-886	솔비	488002	5,640	350 × 40 × 1,310
(2) 0493-885	옥외용 패트비	470090	6,550	340 × 40 × 1,340

Articles

Cat. No

Description

KDY 마당 빗자루, Ground Broom

KOREA



- (1) 마당비 ; 사무실 학교 식당, 특히 아파트 베란다에서 물청소
- (2) 울트라가든비 ; 빗살 끝이 가늘게 갈라져 있어 작은 먼지도 부드럽게 청소가 가능하며, PET재질로 탄성이 우수함
- (3) 개량비 ; 빗살이 굵고 길어 넓은 면적을 쉽게 청소 가능 쓰레기, 낙엽, 눈까지 다목적으로 사용 가능

<B3>

ORDER NO.	품명	타입	PRICE, ₩ Ea.	규격(mm) 폭×길이	포장단위 Ea. / Pk.
(1) 0484-536	마당비	소	1,620	280×690	1 / 30
0484-537	마당비	중	2,240	300×860	1 / 20
(2) 0484-541	울트라 가든비	-	5,720	330×1,400	1 / 10
(3) 0484-545	개량비	소	4,830	1,550×120	
0484-546	개량비	중	5,520	1,580×140	1 / 12
0484-547	개량비	대	5,770	1,600×160	



쓰레받이, Dustpan

KOREA

<B3>

ORDER NO.	품명	MODEL NO.	PRICE, ₩	규격(mm) 가로×세로×높이
▶ 0493-849	쓰레받이 A	940012	1,560	245×340×60
▶ 0518-793	옥외용 쓰레받이	980056	13,530	360×120×970

, Plungers 배수관 청소



Nylon Long-Flexible Drain Clear, with Ring Handle, L530×w12mm NEW
For Remove Clogging of Drain, Simple Operation, 배수관 클리어, 일체형

- 인체에 유해한 화학약품을 사용하지 않아도 되며, 복잡한 배수관을 분해할 필요없이 간단하게 배수관 청소 가능
- 막힌 배수관 입구에 깊숙히 넣으면 배수관의 이물질이 걸리게 되며 상품을 배수관으로부터 제거시에 물질이 튀지않게 천천히 당겨 제거해야함

- * The Fast and Easy way to Clean Clogged and Slow Running Drains
- * For Use in many Residential Drains; Sinks, Showers, Bathtubs
- * Easy to use- Simply Push end into Drain as far as possible; then pull up to Remove Clogging

<B1>

DH.Cle3001 Nylon Long-Flexible Drain Clear, L530×w12mm

Ea.	Price, ₩
	1,540



변기 압축기, Toilet Plunger

KOREA

<B3>

ORDER NO.	품명	MODEL NO.	PRICE, ₩
(1) 0493-843	파워 2중 압축기	500520	5,100
(2) 0493-841	파워 피스톤 압축기	500704	6,370

Articles		Cat. No	Description		
	에어컨 클리너 Air Conditioner Cleaner Spray	KOREA			
<ul style="list-style-type: none"> ■ 에어컨 냉각핀 세정 ■ 세균과 냄새 제거로 건강하고 상쾌한 냉난방 유지 ■ 냉각핀에 직접 분사해도 에어컨에는 아무런 해가 없음 					<B3>
ORDER NO.	MODEL NO.	PRICE, ₩ Ea.	용량(ml)	포장단위 Ea. / Cs.	
0470-626	ACC-10	3,900	420	1 / 20	
	먼지 제거제 Dust Remover Blower	KOREA			
					<B3>
<ul style="list-style-type: none"> ■ 사용 후 잔유물이나 응축물이 남지 않음 ■ 불연성으로 화재걱정 없음 					<B3>
ORDER NO.	MODEL NO.	PRICE, ₩ Ea.	용량(g)	포장단위 Ea. / Cs.	
0523-132	DR-99	3,840	200	1 / 24	



3M® High Performance of Biodegradability Multiuse Cleaner, Hypo-allergenic Spray, 600 & 820ml
Ideal for Remove Old Stains, Oil and Dust, **생분해성 고성능 클리너, 오일/묵은때 용** **NEW**

- 천연 오일을 이용한 세제, 피부 저자극성, 각종 찌든때, 오일, 먼지 제거에 유용
- * Ideal for Remove Old Stains, Oil and Dust

3M.08.1013 Cleaner, Biodegradability(생분해성), 600ml
3M.08.1014 , 820ml

Ea.	Price, ₩	Cs.	Price, ₩
	2,670	12ea	
	3,560	12ea	



3M® Multi-purpose Cleaner, High Detergency, Easy to Use for Cleaning, Spray, 740ml **NEW**
Ideal for Remove Old Satins, Pen Mark, Oil, **다용도 강력 클리너**

- 세정력이 매우 뛰어남; 찌든때, 펜마크, 기름 성분 등의 각종 오염을 제거시 사용
- * Ideal for Remove Old Satins, Pen Mark, Oil * Orange Scent

3M.08.1015 Cleaner, Multi-purpose, 740ml

Ea.	Price, ₩	Cs.	Price, ₩
	2,800	12ea	



3M® "Pro-Metal" Liquid Metal Cleaner, Spray-type, Water Based, Oil-Free, 740ml **NEW**
Ideal for Cleaning All Type of Metal, No Water Mark, Quick Drying, **금속 크리너**

- 금속 표면 세정 및 보호 코팅 작업시 사용, 물자국이 남지 않음
- Scotchgard™ 보호성분이 금속표면에 보호막을 형성하여 오염을 흡착 방지, 손쉬운 세정이 가능
- * Invisible Layer of Protection on Stainless-steel Surfaces Making them Easier to Clean
- * Helps Reduce Labor and Time Saving * Suitable for Spot Cleaning of Industrial Materials

3M.08.1016 Metal Cleaner Spray, 740ml

Ea.	Price, ₩	Cs.	Price, ₩
	6,310	12ea	



3M® Premium Multiuse Adhesive Remover-Cleaner, Strong Cleaning Efficiency, 295g **NEW**
Excellent for Removal of Adhesive Residue, **다용도 접착제 제거제, 프리미엄**

- 천연 오일 성분을 함유한 강력 크리너, 탁월한 세정력과 세척력
- * Made of Natural Citrus Oil Based * Removing without Damaging the Surface
- * Wipes Away with Water after Use * Suitable for Adhesive Residue, Grease, Tar, Oil, Old Stains, and etc.
- * It Clean without Streaking and Has Proven to be Excellent for Cleaning a wide Variety of Industrial Materials

3M.08.1003 Premium Adhesive Remover, 295g

Ea.	Price, ₩	Cs.	Price, ₩
	5,320	12ea	

Articles

Cat. No

Description

NABAKEM 스티커 접착 제거제 KOREA
Sticker(Glue) Remover Spray

- 무자극 크리너
- 세척과 광택의 이중효과
- 금속, 플라스틱, 고무, 페인트에 안전
- RoHS(6대 유해물질) 검출안됨

SSR-450 ▶



<B3>

ORDER NO.	MODEL NO.	PRICE, ₩ Ea.	용량(ml)	포장단위 Ea. / Cs.
▶ 0470-602	SSR-450	5,080	450	1 / 20

NABAKEM 페인트 & 가스켓 제거제 KOREA
Paint & Gasket Remover, Spray

- 페인트, 가스켓의 박리
- 에나멜 동선의 박리
- 사출금형의 탄화물 제거
- 금속면에 부식이 없음



<B3>

ORDER NO.	MODEL NO.	PRICE, ₩ Ea.	용량(ml)	포장단위 Ea. / Cs.
▶ 0470-583	PR-50A	6,550	420	1 / 20

BEX 전기 접점부활제 KOREA
Electro Contact Cleaner, Spray

- 강력세척, 접점부활제
- 탁월한 침투로 기름, 구리스, 먼지 등 신속히 용해, 증발
- 컴퓨터 부품, 자동화기기, 가전제품, 정밀기기, 의료기기에 사용



<B3>

ORDER NO.	MODEL NO.	PRICE, ₩ Ea.	용량(g)	포장단위 Ea. / Cs.
▶ 0223-968	BW-100	15,000	225	1 / 20
▶ 0442-893	BW-100	28,330	450	1 / 12

NABAKEM 금속·금형 세정제(고기능) KOREA
Hi-Function Metal & Mold Cleaner

- High-Efficiency Spray
- 기존 금형크리너에 비해 저독성 용제 사용
- 냄새가 적어 친환경 세정제



<B3>

ORDER NO.	MODEL NO.	PRICE, ₩ Ea.	용량(ml)	포장단위 Ea. / Cs.
▶ 0479-894	C1	12,850	420	1 / 20

NABAKEM 녹 제거제 KOREA
Rust Remover, Spray

- 녹과 반응하여 보라색으로 변화하므로 제거효과를 육안으로 확인
- 중성타입으로 산성타입이나 알칼리타입에 비하여 안전하게 사용
- 녹제거 전용으로 거품이 발생하지 않으므로 후작업시 편리



▲ 500g

<B3>

ORDER NO.	MODEL NO.	PRICE, ₩ Ea.	용량	포장단위 Ea. / Cs.
▶ 0470-595	FC-1	8,730	500g	1 / 20

NABAKEM 고속 침투 녹분해 세척제 KOREA
Penet Oil for Rust Release, Spray

- ▶ High Speed Penetration and Rust Release
- 고속 침투 분해 세척제
- 녹과 열에 의해 고착된 볼트, 부품 해체에 최적
- 침수된 장비의 복구에 효과적
- 기계부품 및 전기계통의 보호에 적합



<B3>

ORDER NO.	MODEL NO.	PRICE, ₩ Ea.	용량(ml)	포장단위 Ea. / Cs.
▶ 0470-600	P-840	5,040	420	1 / 20

NABAKEM 용접 스파터부착 방지제 KOREA
Anti Spatter Agent

- 용접시 불통의 부착 방지
- 용접면의 녹방지 및 방청
- 철, 스테인리스 용접 시 부착 방지

▶ 420ml



<B3>

ORDER NO.	MODEL NO.	PRICE, ₩ Ea.	용량	포장단위 Ea. / Cs.
▶ 0470-728	AS-70	4,740	420ml	1 / 20
▶ 0242-452	AS-70	138,190	18ℓ	1 / 1

NABAKEM 용접 슬래그 제거제 KOREA
Welding Slag Remover

- 용접 슬래그 제거제
- 비부식성으로 금속에 안전
- 용접 슬래그의 유동성이 좋고 포피 박리성이 우수
- 기존에 비해 슬래그 박리성 탁월(3배 이상)
- 모재온도 60℃에서 슬래그 박리성 양호
- 우수한 침투력
- 비부식성으로 금속에 안전
- BLOW HOLE 발생이 없다(2PASS시)



<B3>

ORDER NO.	MODEL NO.	PRICE, ₩ Ea.	용량(ml)	포장단위 Ea. / Cs.
▶ 0471-805	WS-80	6,370	420	1 / 20

Articles	Cat. No	Description
----------	---------	-------------



NABAKEM 가스 누출 검사제, Gas Leak Checker Spray KOREA

- 미세한 누출도 확실하게 감지
- 사용후 금속 및 호스에 부식을 주지 않으며, 장기보관이 가능
- 무취, 무독성

ORDER NO.	MODEL NO.	PRICE, ₩ Ea.	용량(ml)	포장단위 Ea. / Cs.
▶ 0470-621	BC-100	4,150	220	1 / 20
▶ 0495-745	BC-100(스트로우형)			

, Vacuum 진공 청소기

KDY 휴대용 진공 청소기, Portable Vacuum Cleaner 다국적



■ Rechargeable, 차량용에 적합, 강력 흡입력

- 다양한 액세서리로 손에 닿지 않는 곳, 좁은 틈새 먼지도 완벽하게 청소
- 먼지필터의 미세한 먼지 분리로 모터에 먼지가 들어가는 것을 방지
- 재질 : ABS
- 소음 : 80dB
- 흡입력 : 2,700PA
- 전압 : 5V
- 무게 : 0.66kg
- 충전시간 : 3.5시간
- 출력 : 45W
- 규격 : 83×83×293mm
- 사용시간 : 최대 25분

ORDER NO.	MODEL NO.	PRICE, ₩ Ea.	포장단위 Ea. / Cs.
0483-956	KPV-3525	39,200	1 / 20

+ 산업용 청소기 (3모터), 104 Lit, Industrial Vacuum Cleaner, 3 Motor, Dry & Wet KOREA



- 규격 : 104 Lit
- 규격 : 650×720×1,100mm
- 재질 : 스테인리스
- 진공도 : 2,700mmH₂O
- Dry & Wet-type
- 중량 : 47kg
- 전압 : 220V/60Hz
- 코드선종류 : 25A13M3P(연직)

ORDER NO.	MODEL NO.	PRICE, ₩	타입	용량 (ℓ)	소비전력 (W)
0236-717	SUPER-1000	990,640	건/습식	104	4,050

, Water 고압세척기



WORX INNOVATION 충전 고압세척기 Cordless High Pressure Water Cleaner



WG630E.2

주문번호	0528-398	사용시간	터보모드 13분 에코모드 18분
전압	20V	정력토출량	210ℓ/시간
중량	2.5kg	최대압력	25bar
배터리	2.5Ah(1pcs)	정가	256,480

EXP 고압 물 세척기, High Pressure Water Cleaner, Electric Coded 다국적

(1) Midi-type



▲ EHP-120

공통

- 자흡기능 장착으로 고인 물을 스스로 흡입하여 물 공급
- 원터치 호스카플러가 내장되어 있어 편리한 호스장착 가능
- 원터치로 분리와 결합 용이

- 최대토출량 : 7.2 ℓ/min
- 호스길이 : 5M



(2) Standard-type



EHP-165 ▶

- 최대토출량 : 7.2 ℓ/min
- 호스길이 : 8M



<B3>

ORDER NO.	MODEL NO.	PRICE, ₩	규격(mm)	소비전력(W)	최대압력(Bar)	중량(kg)
▶ 0515-355	EHP-120	135,240	336×329×277	1,500	120	7.5
▶ 0463-731	EHP-165	245,000	365×350×790	2,100	165	18

Articles	Cat. No	Description
----------	---------	-------------



NEW KANU™ Black Coffee, Mild & Sweet, Instant Coffee Beans, Americano's Natural Taste & Scent **NEW**
Espresso Extraction, High Quality, **인스턴트 원두커피**

- **마일드·스위트, 원두커피의 퀄리티에 편리함을 더함**
- * Mild : Taste & Scent with Medium Roasting
- * Sweet : Medium Roasting Coffee with Xylose Sugar
- * Convenient Taste & Scent of Coffee * High-Quality Coffee Powder

DH.Cof1001 (1) Coffee, Mild, 0.9g × 100ea
DH.Cof1002 (2) , Sweet, 2.9g × 100ea

<B5>

Pk.	Price, ₩
100ea	22,370
100ea	23,350



NEW MAXIM™ Mix Coffee, Mocha Gold · White Gold · Ice, Original Taste & Scent **NEW**
Golden Ratio Mix, Good Beans, with Xylose Sugar, **믹스커피**

- **고품질의 커피 본연의 맛과 향을 즐길 수 있는 믹스커피**
- * Mocha Gold : Original Taste & Scent of High-Quality Coffee
- * White Gold : Original Taste & Scent of Coffee with Milk
- * Ice Coffee : Soluble in Cold Water, 100% Arabica Beans
- * Made by Innovation Roasting Technology

DH.Cof1011 (1) Coffee, Mocha Gold, 12g × 100ea
DH.Cof1012 , 12g × 170ea
DH.Cof1015 (2) Coffee, White Gold, 11.7g × 100ea
DH.Cof1016 , 11.7g × 170ea
DH.Cof1019 (3) Ice Coffee, 13g × 100ea

<B5>

Pk.	Price, ₩
100ea	16,130
170ea	25,540
100ea	16,500
170ea	25,310
100ea	22,850



NEW Dongsuh® Traditional Tea, Solomon's Seal Tea · Green Tea & Brown Rice, Easy Tea Bag **NEW**
Healthy Drink, Deep Taste & Scent, **동글레차 · 현미녹차**

- **진한 맛과 구수한 향의 티백차**
- * Solomon's seal tea : Unique Savory Taste
- * Green Tea & Brown Rice : Savory Taste of Brown Rice & Taste of Green Tea
- * Easy and Convenient Tea Bag

DH.Tea1001 (1) Tea, Solomon's Seal Flavor, 1.2g × 50ea
DH.Tea1002 , 1.2g × 100ea
DH.Tea1005 (2) Tea, Green Tea & Brown Rice Flavor, 1.5g × 50ea
DH.Tea1006 , 1.5g × 100ea

<B5>

Pk.	Price, ₩
50ea	7,710
100ea	10,280
50ea	6,370
100ea	9,050



NEW TIO™ Ice Tea, Peach · Lemon, Fruit Powder & Black Tea, with Xylose Sugar **NEW**
Non-Caramel Color, Soluble in Cold Water, **아이스티, 복숭아맛 & 레몬맛**

- **자일로스 슈거를 사용하여 설탕 부담을 줄인 아이스티** ■ **찬물에도 잘 녹음**
- * Peach Flavor : Refreshing Taste of Peach Juice Powder & Black Tea
- * Lemon Flavor : Refreshing Taste of Lemon Juice Powder & Black Tea
- * Use Xylose Sugar with Reduced Absorption * Natural Color of Juice & Black Tea

DH.Tea1011 (1) Ice Tea, Peach Flavor, 13g × 18ea
DH.Tea1012 (2) , Lemon Flavor, 13g × 18ea

<B5>

Pk.	Price, ₩
18ea	5,870
18ea	6,610



NEW LOTTE® e-Life™ Paper Cup, Non-Fluorescent Pulp, Thick & Sturdy, 184ml(6.5oz) **NEW**
Clean & Safe, Convenient Use, Top φ70×h70mm, **일회용 종이컵**

- **Made in Korea**
- **무형광 필프원단을 사용하여 안전하고 깨끗함**
- * 170g Thicker, Sturdy & Leak-tight
- * Convenient Use for Work & Outdoor Activities

L5.611 Paper Cup, Top φ70 × h70mm, 6.5oz(184ml)

<B3>

Pk.	Price, ₩	Cs.	Price, ₩
50ea	610	20pk	11,000



SciLab® DURAN glass Rotary Evaporating Condenser, Safety-Type **NEW**
 φ 85 × h400mm, for "SEva-05", 프리미엄 회전진공 농축기 병각기

- Made in Korea ■ Made Borosilicate Glass 3.3
- * with PBT GL25 Cap & PP GL10 Opentop Cap
- * 1,600cm² Cooling Surface Condenser
- * Superior Evaporation Capacity : Max. 23m³/min(Water)

SL.Con2059 Glass Condenser, φ85×471mm

<L1>

Ea.	Price, ₩
	696,030

Conductivity

Suntex® Portable Conductivity · Resistivity · TDS · Salinity · Temp. Meter Set, "SC-210" & "SC-230" **NEW**

With Graphical Menu, IP65 Waterproof, Advanced Autoread Function, Data Logger, 휴대용 다기능 전도도 미터 세트

NEW



"SC-210" & "SC-230" Portable Cond. Meter

- * Rich Functions under the Simple and Easy-to-understand Graphical Menu
- * A Novel Streamlined Shape, Suitable for both Texture and Weight, Coupled with the Beautiful and Simple Keypad Design, it is easy to Hold and Control with One Hand
- * Graphic Menu Design with IP65 Waterproof Protection.
- * Using a Single Key to Start, Restart and Suspend the Advanced Auto Read Function
- * The Advanced Data Logger Function : "SC-210" up to 100 Sets, "SC-230" up to 50,000 Sets
- * **Complete Set with** : Basic Unit, Carrying Case, 4 × AA Battery, Operation Manual, (with/without) 4-electrode Conductivity Probe

<L1>

Model	"SC-210"	"SC-230"
Measurement Range	Cond. 0μs/cm~200ms/cm Resist. 0~20 M.Ω · cm TDS 0~2000ppm, 0~200ppt	Cond. 0μs/cm~1000ms/cm Resist. 0~100 M.Ω · cm TDS 0~2000ppm, 0~1000ppt
Resolution & Accuracy	Sal. 0~70ppt, Temp. -10.0~110.0°C Cond. 0.001/0.01/0.1/1 μs/cm, 0.01/0.1/1 ms/cm, ±0.5% Resist. 0.01 M.Ω · cm, ±1%, TDS 1ppm/0.1ppt, ±0.5% Sal., 0.01ppt, ±0.5%, Temp : 0.1/0.01°C, ±0.2°C	
Temperature Compensation	NTC30K/PT1000 Auto Temperature Compensation, Manual Adjustment	
Auto Power-off	Yes (Automatic Shutdown Time can be Set)	
Display	3" Graphic LCM Backlight Display, with Manual Brightness Adjustment	
Data Storage	Auto/Manual 100 Sets (GLP)	Auto/Manual 50,000 Sets (GLP)
Data Transmitting	-	Micro USB
Dimensions & Weight	w194 × d82 × h38mm, 250g, IP65 Protection	
Power Supply	4 × 1.5V AA or 1.2V NiMH Batteries	4 × 1.5V AA or 1.2V NiMH Batteries Micro USB Power Delivery Function (No Battery Charging Function)
Cat. No. (without Cond. Probe)	SU.SC210	SU.SC230
Price, Each. ₩	797,650	951,420
Cat. No. (with Cond. Probe)	SU.SC210PA	SU.SC230PA
Price, Each. ₩	1,119,360	1,265,440

Spare & Optional Accessories

SU.8.243 4-electrode Conductivity Probe (cell :0.7)

Ea.	Price, ₩
	380,660

Articles

Cat. No

Description



NEW

Multi use Stainless-steel Square Can, with Lid, 다용도 스테인레스 4각 캔 NEW

<L3>

■ Made in Korea * Multi-purpose : Laboratory, Medical.

C9.302G Square Can, 70×70×h50mm, 230ml Full
C9.304G , 125×125×h75mm, 1000ml Full

Ea.	Price, ₩
	6,300
	15,110

, Plastic 컨테이너

Wis. 25~1,000ml PP Straight Sided Volume™ Container, Precisely Graduated, Autoclavable NEW

Jar-type, Transparent, with BS Standard Large Neck Screwcap / Liner-less, Good for Foodstuffs and Laboratory, 대광구 정밀눈금 컨테이너



NEW

■ Made in Korea ■ Ideal for Foodstuffs and Laboratory for Storage of Samples, Powders, etc.

* Useful Straight Sided / Large Neck Bottles with Liner-less Screwcaps
* Transparent Bottle and White Opaque Cap. BS Standard Thread
* Good Chemical Resistance & High Temperature 125/140°C, Autoclavable

<L1>

DH.Con	Container, PP, scale,	Capacity	Dimension
DH.Con3012	Container, PP, scale, 25 / 5ml	25 / 5ml	φ37×h37mm
DH.Con3013		50 / 5ml	φ37×h64mm
DH.Con3014		125 / 12.5ml	φ58×h60mm
DH.Con3015		250 / 25ml	φ58×h106mm
DH.Con3016		500 / 50ml	φ92×h95mm
DH.Con3017		1,000 / 50ml	φ92×h168mm

Pk.	Price, ₩	Cs.	Price, ₩
5ea	5,760	12pk	63,890
5ea	6,710	9pk	55,820
4ea	6,420	9pk	53,370
4ea	10,680	6pk	59,250
4ea	14,020	2pk	25,950
4ea	15,300		



NEW

DM.13.1001

UN Transport Container, PP, 1000ml, Secondary Container Including Absorbent · Cushioning Material · Labels For Safe Transport of Pathogenic Organisms & Clinical Specimens, 유엔 수송 용기, 스왑튜브 수송용 NEW

■ WHO 감염성 물질 운송규정을 따른 용기

■ 감염 물질 및 검체의 안전한 이동을 위한 수송용기(흡수패드 / 완충포장지 / 라벨 포함)

■ Packaging for Infectious Substance (UN2814 / UN3373)

■ Tightly Sealed to Prevent Possible Leakage.

* Category A : An Infectious Substance which is Transported in a Form that, when Exposure to it Occurs, is Capable of Causing Permanent Disability, Life-threatening or Fatal Disease in otherwise Healthy Humans or Animals. (S30.bot3001)

* Category B : An Infectious Substance which does not Meet the Criteria for Inclusion in Category A. (S30.bot3002)

* According to ISO 9001:2015 Quality Management System (K-QA-Q031478)



DM.13.1002

Specifications & Ordering information

<M5>

Cat No.	Total Volume (ml)	Internal Dimension (mm)	External Dimension (mm)	Empty Weight (g)	Pk.	Price, ₩
DM.13.1001	1,000	132×155	164×164×168	260g	10ea	100,000
DM.13.1002	1,000	107.5×176.3	112×110×190	147g	10ea	75,000



NEW

Optional Lid

1.6 & 4.3Lit PFA Containers, Rectangular, Translucent NEW

Excellent for Chemical and Heat Resistance, Autoclavable, Approx.220°C, PFA 사각 컨테이너

■ 내열성 & 내화학성이 아주 뛰어난 탱크 / 컨테이너

■ Made of PFA(Fluoro resin)

* It is Compatibility Stacked with Different Size : Small one on Large one

<L2>

SL.Con	Container, PFA, Rectangular,	Capacity	Dimension
SL.Con4101	Container, PFA, Rectangular, 1.6L,	1.6L	Outer w202×d142×h68mm
SL.Con4102		4.3L,	Outer w202×d142×h170mm
SL.Con4103	Optional ; PFA Lid fo 1.6 & 4.3L		

Ea.	Price, ₩
	463,520
	663,460
	218,130



NEW

270 & 960ml Reusable PP Food Container Set, Microwavable, Stackable NEW

Ideal for Storage and Transport, Multiuse, -10°C +125/140°C, 식품보관용 간편용기

■ Made in Korea

■ 전자레인지, 식기세척기, 냉동실 사용가능

* Made of PP(Polypropylene), -10°C +125/140°C

* Stackable, Multi-purpose Sealing Lid Box

* Microwave, Freezer Usable

<B1>

DH.Con	Container, PP, Storage,	Capacity	Dimension
DH.Con3031	Container, PP, Storage, 270ml,	270ml	130×90×h50mm
DH.Con3032		960ml,	140×140×h85mm

Ea.	Price, ₩	Pk.	Price, ₩
	740	3ea	2,040
	1,110	4ea	4,080



PP Container, Stackable, with Silicone Lid, 4~16Lit NEW
 Ideal for Storage and Carrying, -10°C +125/140°C, 저장/이동 컨테이너

■ Made in Korea

* Ideal for Storage and Carrying

* Lightweight for Easy Handling

<B1>

DH.Con3101	(1) Container, PP, with Lid, Clear	, 194 × 264 × h144mm, 4Lit
DH.Con3102		, 180 × 245 × h190mm, 7Lit
DH.Con3103		, 230 × 318 × h175mm, 10Lit
DH.Con3105	(2)	, Amber, 176 × 245 × h112mm, 4Lit
DH.Con3106		, 165 × 230 × h190mm, 7Lit
DH.Con3107		, 230 × 318 × h164mm, 10Lit
DH.Con3108		, 220 × 310 × h270mm, 16Lit

Ea.	Price, ₩
	4,080
	6,120
	6,120
	4,080
	6,120
	6,120
	10,200



PP Modular/Utility Container/Tray, with Perforated Wall, White, Stackable, 1.1~4.5Lit NEW
 Ideal for Drying · Storage · Transfer · &c, -10°C +120°C, 모듈 중첩형 컨테이너/트레이

■ Made in Korea

■ PP 재질로 내구성이 좋고, 각기 다른 사이즈와 중첩하여 사용 가능

■ It is Compatibility Stacked with Different Size : Small one on Large one

* PP(Polypropylene) ; Good Chemical & Hi-Temp Resistance, Autoclavable

* Lightweight for Easy Handling * Feeble Durability

<B1>

DH.Con3087	Basket Tray, PP, 120 × 160 × h79mm, 1.1Lit
DH.Con3088	, 168 × 242 × h79mm, 2.3Lit
DH.Con3089	, 241 × 340 × h79mm, 4.5Lit



Ea.	Price, ₩
	4,480
	5,920
	9,180

Figure ; Module/Stackable

Common Use of Liquid Nitrogen Storage Tank & Canister-type CryoSystem™, 10~50 Lit **NEW**

Without LN₂ Withdrawal Device & Canister, 액체질소 저장/운반 탱크 및 원통형 캐니스터 타입 크리오시스템 겸용, 펌프·캐니스터 별도판매

NEW



10L

20L

30L

50L

Incl. Roller Base



LN₂ Storage Tank



CryoSystem™
Equipped with
“Optional Canister”

■ Low Daily Evaporation Rate of Liquid Nitrogen ■ Strong and Light-Weight Aluminum Construction

- * Made of Antirust Aluminum Alloy
- * Structured with High-vacuumed Super Adiabatic Multi-layers
- * Equipped with Roller Base which is capable of achieving Easy Transportation (only for 50Lit)
- * Easy to Lift and Pour
- * with 2 Handles except for 10Lit

Specifications & Ordering information

<L1>

Model	“YDS-10D” Max. Capa. 10L	“YDS-20D” Max. Capa. 20L	“YDS-30D” Max. Capa. 30L	“YDS-50D” Max. Capa. 50L
Spec.				
Volume	10L	20L	30L	50L
Neck Opening	φ50mm			
Static Evaporation Rate	0.15 Lit/day	0.17 Lit/day	0.17 Lit/day	0.24 Lit/day
Static Storing Period	65 days	120 days	174 days	212 days
Outer Diameter × Height	φ284 × h560 mm	φ345 × h655 mm	φ455 × h685 mm	φ455 × h850 mm
Empty Weight / Full Weight	6.2 / 13.9 kg	8.2 / 23.9 kg	14 / 37.7 kg	18.1 / 58.0 kg
Roller Base	-	-	-	Included
Optional Canister	Max Number	3ea	6ea	
	Outer Diameter × Height	φ38 × h120 mm		
	Max. No. of 1/2cc Straws	780ea		
Cat. No.	DH.Cry7010	DH.Cry7020	DH.Cry7030	DH.Cry7050
Price, Set. ₩	571,550	1,062,140	1,315,030	2,179,930

Optional Accessories



(1) Canister

(2) Dipper

(3) Roller Base

(4) Cane

(5) Cyro-Glove

	Ea.	Price, ₩
DH.Can7901 (1) Canister, Stainless steel, φ38mm × h120mm		63,230
DH.Dip7903 (2) Dipper, Stainless steel, φ38mm × h55mm		
DH.Rol7922 (3) Roller Base		96,740
* When you order, please let us know the volume of your Tank.		
	Pk.	Price, ₩
SPT313 (4) Cane, Aluminum, for 5 Vials (1.2~2ml)	12ea	16,780
TP.MAMWP (5) Cyro-Glove, Waterproof, Mid-arm type, -210℃ +180℃, M	1pair	232,810
* More Cryo-Gloves ⇒ See “Gloves, Temp Resistant-Low Temp” Section		

LN₂ Withdrawal Device

- * Ideal for Low Loss during the Liquid Discharging Process
- * Minimizes the Vaporization of the Liquid Nitrogen in the Container through a Rubber Ball which can be manually Compressed.
- * Be fitted with Pouring Spouts or Dipper to aid in LN₂ Transfer.
- * Infusion Quantity : ≥3 Lit/Min.



	Ea.	Price, ₩
DH.Lwd7911 LN ₂ Withdrawal Device, for 50mm Neck Opening, of 10 & 20 Lit. Adjustable Length : 425-565mm, Weight : 2.4kg		859,830
DH.Lwd7912 LN ₂ Withdrawal Device, for 50mm Neck Opening, of 30 & 50 Lit. Adjustable Length : 470-610mm, Weight : 2.8kg		859,830
DH.Bul7920 Spare Bulb, for LN ₂ Withdrawal Device		16,130

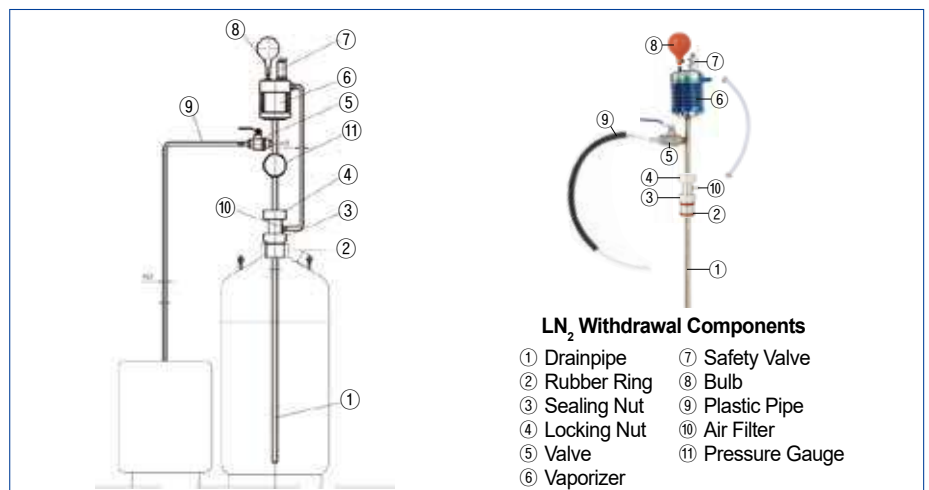

LN₂ Withdrawal Components

- ① Drainpipe
- ② Rubber Ring
- ③ Sealing Nut
- ④ Locking Nut
- ⑤ Valve
- ⑥ Vaporizer
- ⑦ Safety Valve
- ⑧ Bulb
- ⑨ Plastic Pipe
- ⑩ Air Filter
- ⑪ Pressure Gauge

Rack-type Liquid Nitrogen CryoSystem™, without Square Rack & Cryo box, 47~95Lit NEW

Storage Capacity : 1050~3000 vials(1.2 & 2.0ml), 랙 타입 크리오시스템, 사각 랙 별도판매

NEW



Rack-type CryoSystem™, 47~95Lit



Rack : Optional
Equipped with Racks

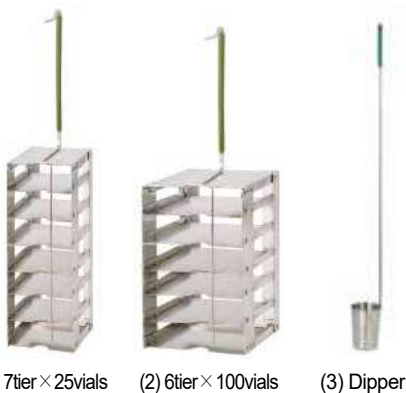

(1) 7tier×25vials (2) 6tier×100vials (3) Dipper



(4) Roller Base



(5) Cryo-Glove



(6) (7) (8)

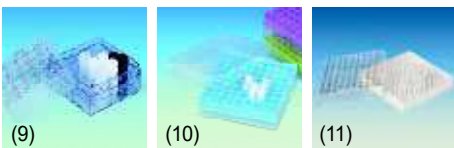

(9) (10) (11)

■ **Low Daily Evaporation Rate of Liquid Nitrogen** ■ **Strong and Light-Weight Aluminum Construction**

* Made of Antirust Aluminum Alloy * Structured with High-vacuumed Super Adiabatic Multi-layers
* Equipped with Roller Base which is capable of achieving Easy Transportation (only for 65 & 100Lit)

Specifications & Ordering information

<L1>

Spec.	Model	"YDS-47-127" Max. Capa. 47L	"YDS-65-216" Max. Capa. 65L	"YDS-95-216" Max. Capa. 95L
Volume		47L	65L	95L
Neck Opening		127 mm	216 mm	216 mm
Static Storing Period		105 days	73 days	100 days
Outer Diameter×Height		φ465×820mm	φ555×785mm	φ678×780mm
Empty Weight		18.6kg	32kg	33kg
Full Weight		56.5kg	84.52kg	110kg
Roller Base		-	Included	Included
Optional Rack	No. of Vial per Box	25	100	100
	No. of Boxes per Rack	7	6	6
	No. of Max Rack Equipped	6	3	5
	Vial Capacity (pcs)	1050	1800	3000
Cat. No.		DH.Cry7147	DH.Cry7165	DH.Cry7195
Price, Set. ₩		2,463,170	3,823,700	5,098,270

Optional Accessories

		Ea.	Price, ₩
DH.Rac7907	(1) Rack, Stainless steel, Square, with 7tier×25vials/box		139,740
DH.Rac7908	(2) , with 6tier×100vials/box		220,350
DH.Dip7904	(3) Dipper, Stainless steel, φ65mm×h100mm		
DH.Rol7922	(4) Roller Base		96,740
	※ When you order, please let us know the volume of your container.		

		Pk.	Price, ₩
TP.MAMWP	(5) Cyro-Glove, Waterproof, Mid-arm type, -210℃+180℃, M	1pair	232,810
	※ More Cryo-Gloves ⇒ See "Gloves, Temp Resistant-Low Temp" Section		

		Ea.	Price, ₩
SL.Box901	(6) Hard Board Box, 81-Holes×φ13mm, w/ Hard Board Divider		2,550
SL.Box902	(7) , w/ PP Divider		2,550
SL.Box9002	(8) , 100-holes×φ12mm, w/ Hard Board Divider		2,810
SL.Rac3026	(9) PC Freezer Box, 25-holes×φ12.3mm, 76×76×h54 mm		3,450
SL.Rac3031	(10) , 81-holes×φ13mm, 130×130×h54 mm, Blue		5,910
SL.Rac3035	(11) , 100-holes×φ13mm, 132×132×h54 mm, white		5,910
	※ More Freezer Boxes ⇒ See the "Racks, Cryovials" Section		

Articles

Cat. No

Description



Biofil® PP 0.5 & 1.5ml Screwcap Tube, Sterile, Clear, with Graduation, Conical bottom & Self-standing
Ideal for Centrifugation and Cryogenic Storage, Leakproof, Autoclavable. 0.5~1.5ml 스크류캡 튜브 **NEW**

■ **Batch Certifications : Every Case (or Pack) is printed a Lot No. for Quality Traceability**

■ **100,000 Clean Grade, Manufactured under ISO13485 : 2016 and ISO9001 : 2015 quality management system**

* Autoclavable at 121°C and Freezable to -80°C

* Screwcap with Silicone O-ring for Leakproof

* DNase/RNase-free and Non-pyrogenic

* Engraved Graduation Ensure Accuracy

* Screwcap for One-handed Operation

* Sterilized by Gamma Irradiation SAL10⁶ (ISO11137)

<L1>

(1) Conical bottom, 0.5ml & 1.5ml

J1.CFT003.005 Screwcap Tube, Conical, Sterile 0.5ml, $\phi 11 \times h40$ mm

J1.CFT006.015 , Sterile 1.5ml, $\phi 11 \times h44$ mm

Pk.	Price, ₩	Cs.	Price, ₩
500ea	59,150	10pk	537,610
500ea	68,870	10pk	625,990

(2) Self-standing, 0.5ml & 1.5ml

J1.CFT005.005 Screwcap Tube, Conical, Sterile 0.5ml, $\phi 11 \times h40$ mm

J1.CFT008.015 , Sterile 1.5ml, $\phi 11 \times h44$ mm

Pk.	Price, ₩	Cs.	Price, ₩
500ea	59,150	10pk	537,610
500ea	68,870	10pk	625,990

2-Year Warranty



(1) Short-model

(2) Tall-model

Upgrade ; With Digital Thermo-Hygrometer



(3) With Digital Thermo-Hygrometer



(4) With Urea Tray ; for Desiccant

SciLab® 33Lit General Purpose PMMA Desiccator, Short- & Tall-form Upgrade With Digital Thermo-Hygrometer · ABS Frame · Shelf · Desiccant Tray, 범용 PMMA 데시케이터

- **Excellent Viewing & Air Tight Structure ; Heavy-duty ABS(Acrylonitrile Butadiene Styrene Resin) Frame, 3mm Clear PMMA(Polymethyl Methacrylate Resin) Body Panel & 5mm Shelf, and Rubber Sealing Door.**
- * Adjustable Shelf Quantity & Height / Distance.
- * 2kg Shelf Load. * 30mm Shelf Moving Interval.
- * Including 1 Urea Tray 190×273mm for Silica-gel / Desiccant.

(1) 33Lit Short-model "DeLL", 1-PMMA Shelf, with Digi. Thermo-Hygrometer

SL.DeLL General Desiccator, Short-model, 33Lit, "DeLL"
Outer : 450×330×h350mm, Inner : 400×305×h270mm

※ 운임 착불 <L2>

Ea.	Price, ₩
	342,130

(2) 33Lit Tall-model "DeLH", 3-PMMA Shelf, with Digi. Thermo-Hygrometer

SL.DeLH General Desiccator, Tall-model, 33Lit, "DeLH"
Outer : 330×330×h480mm, Inner : 270×305×h400mm

Ea.	Price, ₩
	342,130

SL.DeSH003 Spare, PMMA Shelf, for Short-model, 397×302×thick 5mm, Load 2kg
SL.DeSH002 , for Tall-model , 267×302×thick 4mm, Load 2kg
SL.DeDHY , (3) Digital Thermo-Hygrometer, DC, 1~99℃, 11%~99%RH
SL.DeSH006 , (4) Urea Tray for Desiccant 273×190mm

	31,590
	31,590
	21,060
	14,040

Articles

Cat. No

Description



Wisdo ϕ 35~ ϕ 150mm PS Disposable Petri Dish, Sterile, CE Certified **NEW!**
 With Flat Base, Breathing Lugs, Stackable, $-10^{\circ}\text{C} + 70/80^{\circ}\text{C}$, 일회용 멸균 페트리디쉬

- * Made of Polystyrene (PS)
- * Breathing Lugs for Free Air Circulation
- * E.O Sterile Packaging : 10pcs/Pk
- * Easy and Secure Stack.

SL.Dis3001 Dish, Petri, PS, Sterile, $\phi 35 \times h15$ mm
SL.Dis3002 , $\phi 60 \times h15$ mm
SL.Dis3005 , $\phi 150 \times h15$ mm

Pk. Price, ₩	Cs.	Price, ₩
10ea 1,350	100pk	123,610
10ea 1,250	50pk	57,400
10ea 6,210	12pk	68,870

<L1>



PFA Petri Dish, Excellent Resistance to Chemical and Corrosion, $\phi 50 \sim \phi 100\text{mm}$ **NEW!**
 Translucent, Autoclavable, $-200^{\circ}\text{C} + 260^{\circ}\text{C}$, Heat Resistance, PFA 페트리 디쉬, 내열성&내화학성

- Made of PFA(Fluororesin)
- 내열성 & 내화학성이 뛰어난 페트리 디쉬
- * Inner Height : 12mm

SL.Dis4041 Petri Dish, PFA, id. $\phi 50$ / od. $\phi 55$, h16mm
SL.Dis4042 , id. $\phi 76$ / od. $\phi 81$, h16mm
SL.Dis4043 , id. $\phi 100$ / od. $\phi 105$, h17mm

Ea.	Price, ₩
	54,180
	91,310
	117,620

<L2>

Microlit® 0.25~100ml Beatus™ & Lentus™ HF Bottle Top Dispenser, with Adjustable Intake Tube & Flexible Delivery Nozzle With Re-Circulation Valve & Calibration Report, Fully Autoclavable, CE · ISO · DAkkS · IAF Certified

“Standard” & “HF”(for Hydrofluoric Acid)-models, 편리형 디스펜서, 일반형 & 불산형

- “Re-Circulation” 밸브를 통해 공기가 배기되는 동안 시약의 손실을 방지함
 - 스프링 없는 PTFE밸브는 높은 호환성 및 밸브의 보존기간 보장
 - 불산형 디스펜서는 Fluoropolymer Barrel로 제작되어 불산 사용에 적합함
 - Specially Designed Volume Adjustment Knob.
 - Springless Valve with High Purity Ceramic Components Facilitate Smooth and Jam-Free Functioning.
 - Certified ISO 9001, CE, DAkkS(German Accreditation Authority) and IAF(International Accreditation Forum).
- * Easy Calibration * Specially Designed Calibration Tool is provided for Convenient and Quick in-lab user Re-calibration.
 * PTFE Piston with ETP O-Ring Ensures Very High Chemical Compatibility& Wiper Like Smooth, Effortless Piston Movement.
 * The Error Limits are well within the Limits of DIN EN ISO 8655

▶ Complete Set with : ① Dispenser ② Adjustable Intake Tube ③ Calibration Tool ④ Operation Manual ⑤ Calibration Report
 ⑥ PP threaded Adapter Set (28, 30, 32, 38, 40 & 45mm)

※ 38mm Adapter is compatible with US ASTM Thread (38-400) like 4Lit Bottle from “J.T.Baker” or “Weaton”

※ GL 45 Screwneck Bottles : Option(Separate Purchasing)

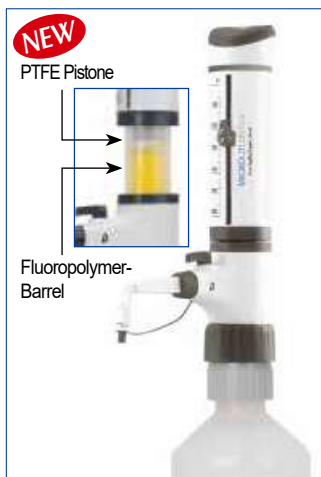
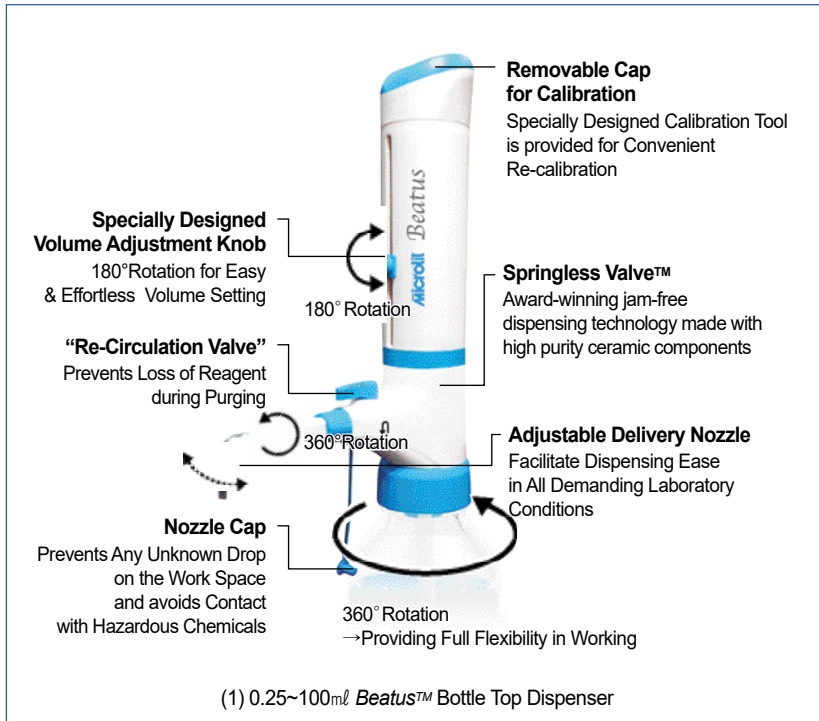

(1) Beatus™ Standard Dispenser Kit, 0.25~100ml, without Bottles

Model	Dispenser, Bottle Top, Beatus™	Range	Accuracy	CV
ML.BEAT.2.5	Dispenser, Bottle Top, Beatus™	0.25~2.5 / 0.05ml	accu. ± 0.015ml	cv.0.005ml
ML.BEAT.5		0.5~5 / 0.1ml	± 0.030ml	.010ml
ML.BEAT.10		1~10 / 0.2ml	± 0.060ml	.020ml
ML.BEAT.30		2.5~30 / 0.5ml	± 0.180ml	.060ml
ML.BEAT.60		5~60 / 1ml	± 0.360ml	.120ml
ML.BEAT.100		10~100 / 2ml	± 0.600ml	.200ml

<L1>

Ea.	Price, ₩
	229,180
	229,180
	229,180
	290,300
	290,300
	381,970

(2) Lentus™ HF Dispenser Kit, for Hydrofluoric Acid, 1~60ml, without Bottles NEW

* Excellent Compatibility with Hydrofluoric Acid, High Purity Media, & Acids

Model	Dispenser, Bottle Top, Lentus™	Range	Accuracy	CV
ML.LEN.10	Dispenser, Bottle Top, Lentus™	1.0~10.0 / 0.2ml	accu. ± 0.060ml	cv.0.020ml
ML.LEN.30		2.5~30.0 / 0.5ml	accu. ± 0.180ml	.060ml
ML.LEN.60		5~60 / 1ml	accu. ± 0.360ml	.120ml

Set.	Price, ₩
	695,750
	946,220
	1,182,780

※ Spare ; Adapters / Intake Tube / Delivery Nozzle ▶ See the page 355

※ Optional ; GL45 Screwcap Bottles : ▶ See the page 140

Articles	Cat. No	Description
----------	---------	-------------

Hammacher® Premium Delicate Scalpel, Stainless-steel 420, *Medicaluse approved*

(1) L155 & L163mm Delicate and (2) L120 · 125 · 129mm Very Delicate, <Germany-made>, 프리미엄 메스, 독일제 외과용, 비자성/비부식 특수스텐



- Germany-made 프리미엄급, 외과용 메스, 비부식, 고강도, 고경도, 내약품성
- 인체 조직의 절단 및 절개등에 사용
- Surgical Stainless-steel 420 ; Rust-proof, High-strength / Hardness / Chemical Resistance

(1) L155 & L163mm Delicate, 정밀형

		Ea.	Price, ₩
HA.HWB220.30	① Fine Scalpels, Overall Length 155mm, Blade : L30×w6.5mm		55,340
HA.HWB222.40	② Fine Scalpels, Overall Length 163mm, Blade : L40×w8.0mm		55,340

(2) L120 · 125 · 129mm Very Delicate, 매우 정밀형

		Ea.	Price, ₩
HA.HWB202.20	③ Precision Knives / Scalpels, Overall Length 120mm, Blade : L20×w4mm		56,270
HA.HWB203.23	④ Precision Knives / Scalpels, Overall Length 125mm, Blade : L23×w4mm New		56,270
HA.HWB201.26	⑤ Precision Knives / Scalpels, Overall Length 129mm, Blade : L26×w3mm		58,270

Hammacher® L130 & 175mm Premium Wax Knife, *Medicaluse approved*

(1) All Stainless-steel and (2) Wood Handle, Stainless-steel, <Germany-made>, 프리미엄 왁스나이프, 독일제 의료용, 비부식



- Germany-made 프리미엄급, 의료용 왁스나이프, 석고 혼합 및 조각에 적합

(1) *Medicaluse* All Rustproof Stainless-steel, 의료용 비부식 올스텐형

* Made of Stainless-steel DIN 1.4117

		Ea.	Price, ₩
HA.HSL108.13	① Wax Knives, All-metal, Overall Length L130mm, Blade L26×w6mm		49,950
HA.HSL109.17	② Wax Knives, All-metal, Overall Length L175mm, Blade L37×w8mm		51,500

(2) With Wood Handle, 우드핸들형, 비부식스텐 **NEW**

* Made of Stainless-steel 410 * Good for Dental- & Medical-Laboratory
* With Excellent Wood Handle for Easy Grip, Non-Autoclavable

		Ea.	Price, ₩
HA.HSL112.13	③ Wax Knives, Overall Length 130mm, Blade L27×w5mm		40,430
HA.HSL115.17	④ Wax Knives, Overall Length 175mm, Blade L37×w7mm		41,050

Webster & Olsen Needle Holder, L135 & 140mm, *Medicaluse* **NEW**

With Serrated-Jaws, Stainless-steel 410, 웹스터 & 올슨 니들홀더/지침기, 의료용, 비부식

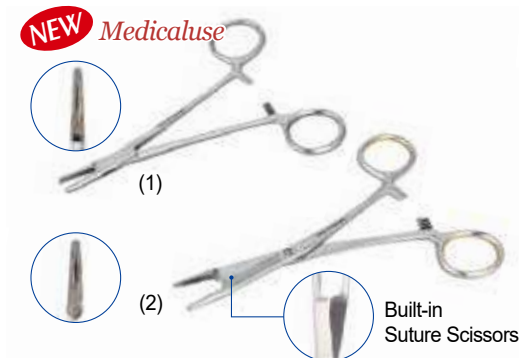

- Stainless-steel 410 : 비부식, 고강도, 고경도, 내약품성
- 니들을 잡고 가이드 하기 위해 사용
- * Rust-proof, High-Strength/Hardness, Chemical Resistance

(1) Webster Needle Holder, L135mm

- * 성형외과, 피부과, 안과 등 작은 부위에 니들을 사용할 경우 적합
- * Used for Microsurgery, Eye Surgery and Plastic Surgery or Subcutaneous Procedures
- * Used with Small Needles and Fine Suture Material

		Ea.	Price, ₩
DM.04.1001	Needle Holder, Stainless-steel, Webster, L135mm		11,800

(2) Olsen Needle Holder, with Built-in Suture Scissors, L140mm

* 니들 홀더와 가위 두 가지 기능으로 사용

		Ea.	Price, ₩
DM.04.1003	Needle Holder, Stainless-steel, Olsen, L140mm		21,640

Hammacher® Premium Mathieu-Kocher & Mathieu Needle Holder, L140mm, *Medicaluse approved* **NEW**

With Slender Jaws, Stainless-steel 420, <Germany-made>, 프리미엄 매튜-코카 & 매튜 니들홀더 / 지침기, 독일제 의료용, 비부식

NEW *Medicaluse*

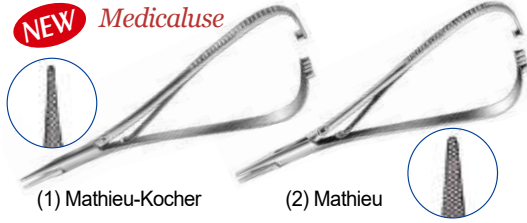

- Germany-made 프리미엄급; 비부식, 고강도, 고경도, 내약품성
- 진료 시 조직을 잡거나 조작, 압박, 절단, 결합 또는 니들을 잡고 가이드 하는데 사용
- Surgical Stainless-steel 420: Rust-proof, High-Strength/Hardness, Chemical Resistance <M1>

HA.HSD005.14 (1) Needle Holder, SS, Mathieu-Kocher, L140mm
 HA.HSD009.14 (2) , Mathieu, L140mm

Ea.	Price, ₩
	82,850
	82,850

Castroviejo Needle Holder, with Smooth-Jaws, L145mm, *Medicaluse* **NEW**

For Microsurgery, Spring Action, Stainless-steel 410, 카스트로비조 니들홀더/지침기, 의료용, 비부식

NEW *Medicaluse*



- Stainless-steel 410 : 비부식, 고강도, 고경도, 내약품성
- 이중 스프링 구조, 미세 정밀 수술은 물론 그림감이 좋아 일반 지침기로도 다양하게 사용 <M1>
- * Stainless-steel 410 : Rust-proof, High-Strength/Hardness, Chemical Resistance

DM.04.1006 Needle Holder, Stainless-steel, Castroviejo, L145mm

Ea.	Price, ₩
	39,330

Articles

Cat. No

Description



Energizer® General Purpose Alkaline Dry-Cell, 1.5 & 9V
 With 100% Checked for Quality Assurance, 알칼라인 건전지

- * Ideal for Flashlights, Portable Electronics, Clocks and Radios, Flashlights, Remote Controls, etc.
- * Clear BLISTER with Description Card Packing
- * Guaranteed for 10 Years in Storage
- * Bulk Package (8ea/PK.& 16ea/Pk.) are MAX Plus type, It has more Efficiency and Stronger Sustainability than Normal

<B4>

Cat. No.	Dry-Cell Type	Pk.	Price, ₩	Cat. No.	Dry-Cell Type	Pk.	Price, ₩
E3.LR03	(1) AAA 1.5V	2ea	990	E3.MN1400	(3) C, 1.5V	2ea	4,260
E3.LR03.8 <i>New</i>		8ea	6,160	E3.MN1400.4 <i>New</i>		4ea	7,920
E3.LR03.16 <i>New</i>		16ea	9,110	E3.MN1300	(4) D, 1.5V	2ea	5,460
E3.LR06	(2) AA 1.5V	2ea	990	E3.MN1300.4 <i>New</i>		4ea	9,800
E3.LR06.8 <i>New</i>		8ea	6,160	E3.6LR61		(5) 9V	1ea
E3.LR06.16 <i>New</i>		16ea	9,110	-	-	-	-



Energizer® Popular Lithium & Alkaline Dry-Cell, Coin-type, 1.5 & 3V
 With 100% Checked for Quality Assurance, 리튬/알칼라인 코인건전지

- * 무수은, Hold Power for 8 years in Storage

<B4>

Cat. No.	Dry-Cell Type	Pk.	Price, ₩	Cat. No.	Dry-Cell Type	Pk.	Price, ₩
E3.CR2016	(1) CR2016, 3V Lithium	2ea	2,390	E3.CR2032	(3) CR2032, 3V Lithium	2ea	2,390
E3.CR2016.5 <i>New</i>		5ea	4,200	E3.CR2032.5 <i>New</i>		5ea	4,200
E3.CR2025	(2) CR2025, 3V Lithium	2ea	2,390	E3.A76	(4) A76, 1.5V Alkaline	4ea	2,390
E3.CR2025.5 <i>New</i>		5ea	4,200	E3.A76.10 <i>New</i>		10ea	4,200



Energizer® Ultimate Lithium™ Anti-Freezing Dry-Cell, Performs in Temp. -40°C +60°C, 1.5V
 Ideal for Low Temperature Environment, Hold Power for Up to 20 years in Storage, 극저온용 리튬건전지

- * Hydrargyrum- / Lead- / Cadmium-Free
- * Clear BLISTER with Description Card Packing
- * Weighs 1/3 Less than Standard Alkaline Dry-Cell
- * Ideal for Temperature Sensitive Laboratory & Industry High-tech Device
- * Leak-proof Construction
- * Suitable for High Power
- * Guaranteed for 20 Years in Storage

<B4>

Cat. No.	Dry-Cell Type	Pk.	Price, ₩	Cat. No.	Dry-Cell Type	Pk.	Price, ₩
E3.AFLR03	(1) AAA, 1.5V, Lithium	2ea	5,260	E3.AFLR06	(2) AA, 1.5V, Lithium	2ea	5,260
E3.AFLR03.4 <i>New</i>		4ea	10,360	E3.AFLR06.4 <i>New</i>		4ea	10,360

NEW



Oxy[®] Charcoal Dehumidifying Agent, for Wardrobe & Drawer-cabinet **NEW**

물먹는 하마 참숯 제습제, 옷장 & 서랍장용

* Absorb amount 500ml
* Using Q'ty : 1~2ea/1m²

* Strong moisture absorb and prevent malodor and mildew
* Ingredient : CaCl₂ / Charcoal

<B4>

03.503261 Agent, Dehumidifying, 500ml

Pk.	Price, ₩	Cs.	Price, ₩
3ea	4,960	6pk	27,500

Articles	Cat. No	Description
----------	---------	-------------

산업용 선풍기, 앞뒤/좌우 회전형, Industrial Electric Fan, Rotary-type, 220V, 60hz KOREA

NEW



- 안전 단형 대용량, Rotating Frame, High Impact-Resin Fan $\phi 18''\sim\phi 30''$ (inch)
- 3단 로터리 스위치 ■ 앞, 뒤 각도조절 / 좌우 회전 ■ 3시간 타이머 부착

0338-922	산업용 선풍기, 회전형/단형, "SGN-45P", $\phi 18''$ Fan, 205W
0338-927	"SGN-50P", $\phi 20''$ Fan, 215W
0338-928	"SGN-60P", $\phi 24''$ Fan, 350W
0362-486	"SGN-75P", $\phi 30''$ Fan, 350W

<B3>	
Ea.	Price, ₩
	157,590
	168,080
	187,290
	233,450

Tiger King 산업용 선풍기, Industrial Electric Fan, Heavy-duty Aluminum Fan $\phi 20''/24''/30''$ KOREA

NEW



버튼스위치

알루미늄 다이캐스팅 모터

- Aluminum Die Casting Motor and Fan 가볍고 단단한 고효율의 긴 수명!
- Friendly 3-Range Speed Button, Adjustable Height of Stand, and Fan Angle Controlled
- 상, 하 높이/상향 각도 조절 가능 ■ 저소음 볼베어링 모터 적용 ■ 절전형 알루미늄 날개 적용
- 3단 속도 조절이 가능한 버튼 스위치 적용 ■ 220V, 230W

0300-460	산업용 선풍기, Stand형, "TKF-20S", $\phi 20''$ Alu-Fan
0300-461	"TKF-24S", $\phi 24''$ Alu-Fan
0300-462	"TKF-30S", $\phi 30''$ Alu-Fan

<B3>	
Ea.	Price, ₩
	132,800
	141,430
	150,920

▶ TKF-24S

씨클레이터 선풍기, 다용도/다기능 Compact형, Electric Circular Fan $\phi 10''$ & $\phi 20''$ CHINA

NEW



▶ (1) CTM-104

(1) Auto-Rotating, 220V, 60Hz, 40W

- 공기순환, 집중바람 ■ 앞 뒤 각도 조절 ■ 좌,우 자동회전, $\phi 10''$ Fan

ORDER NO.	MODEL NO.	PRICE, ₩	규격(INCH)	타입
(1) 0524-254	CTM-104	39,200	10	다각도 조절

NEW



▶ (2) MF-4200TS

(2) 360° Angle Adjustable, 220V, 60Hz, 165W

- 스틸재질의 3EA 날개 $\phi 20''$ ■ 360도 각도조절 가능 ■ 간편한 상단 손잡이

ORDER NO.	MODEL NO.	PRICE, ₩	규격(INCH)	타입
(2) 0477-194	MF-4200TS	164,640	20	360° 조절

가정용 선풍기, Seat- & Stand-types, Household Electric Fan CHINA

NEW

NEW



(1) Seat-type DWF-KH3731A

(2) Stand-type DWF-2167

- Fashionable Design and High Economics
- 좋은 디자인에 높은 경제성

(1) 좌식용 Seat-type, $\phi 14''$ Fan, 220V, 60Hz, 50W

0426-864 가정선풍기, 좌식용 "DWF-KA3731A", $\phi 14''$ Fan

(2) 스탠드형 Stand-type, $\phi 16''$ Fan, 220V, 60Hz, 55W

0426-867 가정선풍기, 스탠드형 "DWF-2167", $\phi 16''$ Fan

<B3>	
Ea.	Price, ₩
	42,150

<B3>	
Ea.	Price, ₩
	44,600

Articles

Cat. No

Description



(1) 1구 콘센트 + 2 USB 포트



(2) 3구 콘센트 ON-OFF형

전기 멀티탭, Electrical Outlet Multi-Tap, 250V

(1) 1구 콘센트 + 2 USB 포트

0488-915 멀티탭 "SGU-1", 1구+2 USB, 10A

<B3>	
Ea.	Price, ₩
	7,130

(2) 3구 콘센트, ON-OFF Switch-type

0257-666 멀티탭 "HET-4", 3구, 1 Switch, 15A

<B3>	
Ea.	Price, ₩
	3,130



(1) HJT-32

다른 콘센트에 간섭없는 형



(2) HJT-33

회전형 멀티탭, Rotating Multi-Tap, 250V

(1) 3구, 1 Switch, 회전형

0395-097 회전멀티탭 "HJT-32", 3구 차단, 16A

<B3>	
Ea.	Price, ₩
	3,390

(2) 3구, 3 Switch, 회전형

0395-098 회전멀티탭 "HJT-33", 3구 개별차단, 16A

<B3>	
Ea.	Price, ₩
	3,920

10~50m 산업용 3구 콘센트와 전선

<B3>

Industry Electric Cable & 3 Socket Outlet



■ 콘센트 보호 커버

ORDER NO.	MODEL NO.	PRICE, ₩ Ea.	규격	포장단위 Ea. / Cs.
0452-875	DSM3-1510	18,240	1.5SQ×3C×10M	1 / 20
0452-876	DSM3-1520	29,610	1.5SQ×3C×20M	1 / 15
0452-877	DSM3-1530	41,160	1.5SQ×3C×30M	1 / 10
0452-878	DSM3-1550	64,890	1.5SQ×3C×50M	1 / 7
0452-879	DSM3-2510	27,150	2.5SQ×3C×10M	1 / 20
0452-881	DSM3-2520	41,560	2.5SQ×3C×20M	1 / 15
0452-882	DSM3-2530	61,750	2.5SQ×3C×30M	1 / 10
0452-883	DSM3-2550	98,790	2.5SQ×3C×50M	1 / 7
0484-121	DSM3-4010	44,790	4.0SQ×3C×10M	1 / 15
0484-122	DSM3-4020	75,760	4.0SQ×3C×20M	1 / 10
0482-706	DSM3-4030	109,760	4.0SQ×3C×30M	1 / 4

10~30m 자동 전선릴 패키지, Auto Wire Package Cable-Reel

KOREA



방우형 2구 콘센트

(1) EER 타입

- 스틸 패키지형, 행거브라켓 제공
- 자동 권취형
- 각종 전기 작업 현장(정비소, 공장, 실습실)
- 설치 위치 : 벽 및 천정(설치높이 3M이내)
- 재질 : 폴리우레탄

* 공통 : 1.5SQ → 10A / 2.5SQ → 15A

(1) EER-type, 10 · 15 · 20m

<B3>

ORDER NO.	MODEL NO.	PRICE, ₩	케이블 사양	길이 (M)	중량 (kg)
0352-261	EER-115	188,160	1.5SQ×3C	15	12
0366-601	EER-120	230,310	1.5SQ×3C	20	14
0374-078	EER-210	188,160	2.5SQ×3C	10	12
0374-080	EER-215	209,830	2.5SQ×3C	15	14



방우형 2구 콘센트

(2) PER 타입

- 스틸 패키지형, 행거브라켓 제공
- 자동 권취형
- 각종 전기 작업 현장(정비소, 공장, 실습실)
- 설치 위치 : 벽 및 천정(설치높이 3M이내)
- 재질 : 폴리우레탄

(2) PER-type, 20 & 30m

ORDER NO.	MODEL NO.	PRICE, ₩	케이블 사양	길이 (M)	중량 (kg)
0376-159	PER-120	225,400	1.5SQ×3C	20	11.2
0376-160	PER-130	250,880	1.5SQ×3C	30	12.2
0376-161	PER-220	278,320	2.5SQ×3C	20	12.2

Articles	Cat. No	Description
----------	---------	-------------

KDY 20~100m 산업용 전선릴, 누전/과부하 차단형, Industry Electric Cable Reel

<B3>



- 누전 & 과부하 차단기 내장
- 3 Socket Outlet

ORDER NO.	MODEL NO.	PRICE, ₩	규격
0452-885	DSE-1530	56,550	1.5SQ×3C×30M
0452-892	DSE-1550	81,840	1.5SQ×3C×50M
0477-336	DSE-15100	147,990	1.5SQ×3C×100M
0452-893	DSE-2530	79,390	2.5SQ×3C×30M
0452-894	DSE-2550	123,190	2.5SQ×3C×50M
0477-342	DSE-25100	232,370	2.5SQ×3C×100M
0477-343	DSE-4020	100,560	4.0SQ×3C×20M
0477-344	DSE-4030	130,350	4.0SQ×3C×30M
0472-239	DSE-4050	201,590	4.0SQ×3C×50M

77 30·50·100m 산업용 방우 전선릴, 누전/과부하 차단형, Rainproof Electric Cable Reel

<B3>



- 개별 방우 콘센트 2개, 이물질 오염방지
- 누전/과부하 차단기 내장

ORDER NO.	MODEL NO.	PRICE, ₩	규격
0504-690	MJM-CK-1530	69,200	1.5SQ×30M
0503-233	MJM-CK-1550	95,170	1.5SQ×50M
0504-691	MJM-CK-15100	169,160	1.5SQ×100M
0504-692	MJM-CK-2530	95,170	2.5SQ×30M
0504-693	MJM-CK-2550	143,190	2.5SQ×50M

KOREAL 10~30m 산업용 자동 전선릴, Auto Electric Cable Reel, "ALE-N" type KOREA

<B3>



- ◀ ALE-N 타입, 각종 전기작업 현장용에 적합.
- 경량 프레임 내장 스프링, 별도 설치 브라켓

ORDER NO.	MODEL NO.	PRICE, ₩	길이 (M)	전류세기 (A)	케이블 사양
0326-430	ALE-210N	128,580	10	15	1.5SQ×3C
▶ 0320-600	ALE-215N	136,230	15		
0320-601	ALE-220N	149,170	20		
0326-431	ALE-230N	184,240	30		

77 기능성 전선릴, Functional Electric Cable Reel

(1) 20·30·50m 절연성 릴케이스 타입 전선릴, 차단형



- ◀ With Electric Insulated Reel Case
- 부도체 및 절연성(릴케이스)
- 누전차단기 내장 1.5SQ(15A), 2.5SQ(30A)
- 과부하 차단기 내장

<B3>

ORDER NO.	MODEL NO.	PRICE, ₩	규격
0328-294	MJM-ES-1520	67,340	1.5SQ×20M
0319-748	MJM-ES-1530	77,920	1.5SQ×30M
0319-749	MJM-ES-1550	108,590	1.5SQ×50M
0319-750	MJM-ES-2530	112,510	2.5SQ×30M
0319-751	MJM-ES-2550	165,340	2.5SQ×50M

(2) 15m 캠핑용 전선릴, Ideal for Camping



- ◀ Comfort Handling System
- 2구 콘센트
- 휴대하기 편한 야외용품(캠핑용)
- 과부하 차단기 내장

ORDER NO.	MODEL NO.	PRICE, ₩	규격
0606-666	MJM-CPE	61,100	1.5SQ×15M

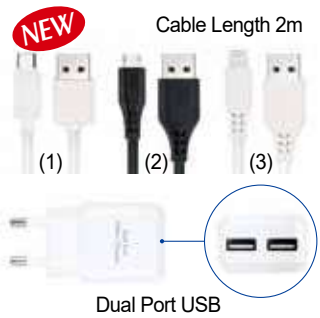

Dual Port Home USB Quick Charger, with 1.0~1.2m USB Cable, Output : 5V 2.1A **NEW**

Ideal for Smart Phone, Battery Charging, 2포트 가정용 고속 USB 충전기

- 2개의 USB에 동시 전력 공급이 가능한 고정형 고속 충전기
- KC Certified ■ Standard USB 2.0 ■ Components : Dual Port Quick Charger and USB Cable × 1Ea.
- * Simultaneously Supply 2 USB Port * Stable Power Supply * Quick Charger
- * Prevent Damage from Over-voltage or Over-current
- * Input : 110~240, 50/60Hz * Output : DC5V 2.1A

DH.Cab3001	(1) Dual Port USB Quick Charger, with USB Type-C Cable
DH.Cab3002	(2) , with Micro 5pin Cable
DH.Cab3003	(3) , with with Apple Lightning 8pin Cable

<B1>

Pk.	Price, ₩
1ea	7,640
1ea	7,640
1ea	7,640

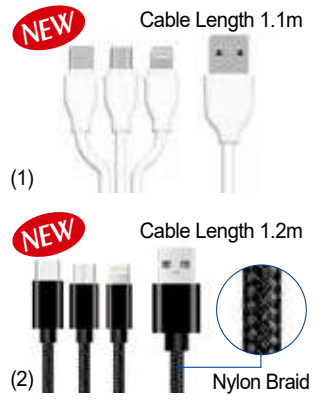

Triple USB Charging Cable, 1.1m and 1.2m, with Type-C, Micro 5pin, Lightning 8pin Connectors **NEW**

Ideal for Smart Phone and More, 3-in-1 USB 멀티 충전 케이블

- 안드로이드와 애플 기기에 사용 가능한 다기능 통합 멀티 충전 케이블
- * Compact Multifunctional Integrated Design
- * Compatible Android Phones and Apple Lightning Port
- * Stable Supply * Quick charge Possible * Equitable Multiple Charging
- * Only for charging, not Support Data Transmission
- * Cable wrapped with Outer Nylon Braid (DH.Cab3005)

DH.Cab3004	(1) Triple USB Charging Cable, 1.1m, Max 3A
DH.Cab3005	(2) , 1.2m, Max 2A

<B1>

Pk.	Price, ₩
1ea	6,720
1ea	14,520

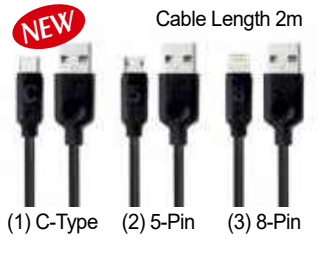

Data & Quick Charge USB Cable, with 2m Long Cable Length, Output 5V/2.0A **NEW**

Ideal for Use in Vehicles and Homes, 고속충전 USB 데이터케이블

- 2m의 긴 길이로, 차량 및 가정에서 사용하기 편리한 고속충전 USB 데이터케이블
- Easy to Use, Quick Charging, with 2m Long Cable Length, Ideal for Use in Vehicles and Homes
- * Can be Choose the type of the Cable C-type, 8-pin, 5-pin

DH.Cab3006	(1) Data & Quick Charge USB Cable, L2m, C-Type
DH.Cab3007	(2) , 5-Pin
DH.Cab3008	(3) , 8-Pin

<B1>

Pk.	Price, ₩
1ea	3,060
1ea	3,060
1ea	3,060

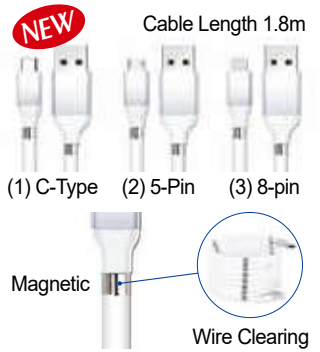

Magnetic Quick Charge Cable, with Magnetic Suction Design, Output 9V/2.0A; 5V/3.0A, L1.8m

Ideal for Use in Vehicles and Homes or Outings, 마그네틱 고속충전 USB 데이터케이블 **NEW**

- 차량 및 가정 또는 외출시 사용하기 편리한 고속충전 USB 데이터케이블
- 자기흡수케이블로 선 정리가 쉽고 편리함
- Easy to Use, Quick Charging, Ideal for Use in Vehicles and Homes or Outings
- Easy and Convenient to Wire Clearing with Self-absorbing Cables
- * Can be Choose the type of the Cable C-type, 8-pin, 5-pin

DH.Cab3011	(1) Magnetic Suction Design USB Cable, L1.8m, C-Type
DH.Cab3012	(2) , 5-Pin
DH.Cab3013	(3) , 8-Pin

<B1>

Pk.	Price, ₩
1ea	12,680
1ea	12,680
1ea	12,680

작업등 Work Light, (1) Cable-type, (2) Cordless Rechargeable LED-type

KOREA



(1) Cable형 작업등

0275-895	작업등60W(전구별도), "KL-201", 7m cable
0283-007	, "KL-203", 15m cable

(2) LED 충전형, Cordless Rechargeable type, 230 × 58 × 47mm

- 스마트폰 5핀 충전기 활용, LG Battery 내장 ■ 연속 5~10시간 단계별 조절사용
- 과충전, 과방전, 과전류 안전장치 적용

0432-087	LED등, "AP-1000", 직진형, 800/1600루멘, 5hr사용
0459-443	, "AP-1001", 확산형, 500/1100루멘, 3/6hr사용

<B3>

Ea.	Price, ₩
	8,560
	14,260

Ea.	Price, ₩
	35,500
	35,500

Articles

Cat. No

Description



(1) 주광 백색 (2) 태양 주황색

LED Bulb, Daylight & Soft White, 8~15W, 6,500 & 3,000K, LED 전구 **NEW**

* Lifetime : approx. 15,000 Hours * Rated Voltage 220V, 60Hz.

<B4>

Description	(1) Daylight, 6500K (주광색, 백색)			(2) Soft White, 3000K (전구색, 오렌지빛)		
	Cat. No.	Ea.	Price, ₩	Cat. No.	Ea.	Price, ₩
LED Bulb, 8W, φ60×h105mm	DH.Bul1001		1,280	DH.Bul1006		1,280
LED Bulb, 10W, φ60×h105mm	DH.Bul1002		1,450	DH.Bul1007		1,450
LED Bulb, 12W, φ60×h116mm	DH.Bul1003		1,610	DH.Bul1008		1,610
LED Bulb, 15W, φ80×h150mm	DH.Bul1004		2,470	DH.Bul1009		2,470



LED Desk Lamp with Stable Light, Flicker Free, Adjustable Brightness Up to 1300Lux **NEW**
With Adjustable Head & Body, Anti-Glare, LED 데스크 램프

■ 5단계 밝기 조절과 2단계 각도 조절 기능이 있는 LED 스탠드 * Eliminates Multiple Shadow and Prevents Disruption to Reading
* Provide Uniform, Soft, and Flicker Free Light : Minimize Eye Fatigue
* Brightness Level Stage : 5 Level * Adjustable Head & Body : Free Angle Control
* Color Temperature : Daylight(5500K) * Power Supply : AC 240V, 8W

<B4>

DH.Lam3001 LED Desk Lamp, 8W, 180×315×h420mm, 700g, White
DH.Lam3002 , Black

Ea.	Price, ₩
	32,630
	32,630



USB Rechargeable LED Stand with Flicker Free, Adjustable Brightness Up to 300Lux **NEW**
With Adjustable Head, Anti-Glare, USB Rechargeable Battery, USB 충전형 LED 스탠드

■ 3단계 밝기 조절과 각도 조절 기능이 있는 이동식 충전형 LED 스탠드
* Provide Uniform, Soft, and Flicker Free Light : Minimize Eye Fatigue
* Brightness Level Stage : 3 Level * Adjustable Head Free Angle
* Usage Time : 5hr(1Level), 4hr(2Level), 3hr(3Level) * Full Charging Time : 3hr
* 3.7V 1200mAh Rechargeable Battery * Power Supply : 5V, 1A USB Cable 1m (Included)

<B4>

DH.Lam3021 USB Rechargeable LED Stand, 80×100×h270mm, 300g, White

Ea.	Price, ₩
	16,800



Removable LED Wall Sconce Light with on-off Switch, Daylight **NEW**
Ideal for Bedroom, Stairs, Hallway, Restroom, 벽등, 콘센트 부착형

■ 은은한 조명으로 침실, 복도, 계단에 고정형으로 사용 * Used by Attaching to Power Receptacle
* Easy Operation with on-off Switch * Color Temperature : Daylight * Small Size Simple Design
* Long Life without Lamp Replacement * Power Supply : AC 250V, 1W

<B4>

DH.Lam3026 Removable LED Wall Sconce Light, 40×45×107mm, 50g

Ea.	Price, ₩
	2,400

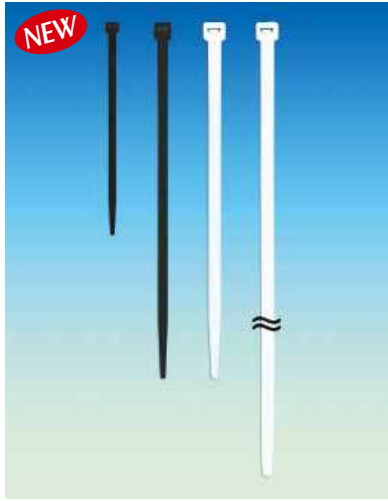

Cais® Nylon Cable Tie, 나일론 케이블타이 NEW

* Nylon 66, 94V-2 Certified by UL. Heat-resisting, Erosion Control, Insulate well and not Apt to Age.
 * Natural (or White, Standard Color), UV Black and Other Color are Available as Requested.

<B4>

ORDER NO.		Width × Length(mm)	dh pk. Price, ₩		Cs. Price, ₩	
White	Black					
C2.T25100	C2.T25100.1	100 × 2.5	100ea	580	10dh pk.	3,790
C2.T36140	C2.T36140.1	140 × 3.6	100ea	1,250	10dh pk.	8,270
C2.T48200	C2.T48200.1	200 × 4.8	100ea	2,470	10dh pk.	16,390
C2.T50270	C2.T50270.1	270 × 5.0	100ea	4,420	5dh pk.	14,710
C2.T48300	C2.T48300.1	300 × 4.8	100ea	4,880	5dh pk.	16,240
C2.T76300	C2.T76300.1	300 × 7.6	100ea	4,420	5dh pk.	14,710
C2.T76370	C2.T76370.1	370 × 7.6	100ea	8,270	3dh pk.	16,520
C2.T90450	C2.T90450.1	450 × 9.0	100ea	17,640		
C2.T90540	C2.T90540.1	540 × 9.0	100ea	28,360		
C2.T90780	C2.T90780.1	780 × 9.0	100ea	44,110		



Cais® Marker Tie, Available to Tie Max. φ22mm, with Tag, 마커 타이

■ 펜과 스티커 등으로 분류별 마킹이 가능하여 효율적인 선 정리 가능

* Nylon 66 94V-2 Certified by UL. Acid Control and not Easy to Age.
 * Write Down the Marker on the Tag, Tag Size w8 × L25mm

<B4>

C2.100MT Marker Tie, w2.5 × L100mm
 C2.200MT , w2.5 × L200mm New

dh pk. Price, ₩	Cs. Price, ₩
100ea 2,510	10dh pk. 16,670
100ea 3,050	10dh pk. 20,310



Cais® Reusable Cable Tie, Easy Assembling, 재사용 케이블 타이

■ 해제 버튼이 있어서 쉽게 재사용 가능

* Nylon 66 Certified by UL. * Easily Assembled by Hand or with Pliers

<B4>

C2.200RT Reusable Cable Tie, w4.8 × L200mm, Max. Bundle φ50mm New
 C2.250RT , w7.2 × L250mm, Max. Bundle φ65mm

dh pk. Price, ₩	Cs. Price, ₩
100ea 5,380	10dh pk. 35,840
100ea 10,560	5dh pk. 35,150



Cais® Cord Band, General Purpose, 코드/케이블 밴드(타이)

■ Supplied by Cais® in Korea ■ Cord Band, Polyethylene

C2.CB150 Cord Band, Color-Natural, 157mm
 C2.CB150.1 , Color-Black, 157mm New

<B4>

dh pk. Price, ₩	Cs. Price, ₩
100ea 3,290	5dh pk. 10,920
100ea 3,290	5dh pk. 10,920



Cable Tie Band, with Carabiner, Ideal for Organized Storage, 케이블 타이 정리기 NEW

■ 케이블 타이 작업 및 보관에 효과적

* Phosphorescence Function (About 30 Min Luminous after Light Absorption)
 * Simple Lever Operation, easy to use with One-touch Method
 * Includes Carabiner for easy Holding * Inner Diameter : up to 35mm

<B4>

DH.Ele3001 Cable Tie Band, 8.7 × 8 × 12mm

Ea. Price, ₩
5,880

Articles	Cat. No	Description
----------	---------	-------------

Wisdom ϕ 50mm Membrane Filter, MCE · Nylon · PES · PTFE · PVDF-Hydrophilic/-Hydrophobic, 0.22/0.45 μ m **NEW**

Ideal for Microfiltration, Sample Purification, Sterile & Non-sterile, ϕ 50mm 멤브레인 필터, 멸균 & 비멸균



(1) ~ (5) Membrane Filter, 0.22 / 0.45 μ m, ϕ 50mm

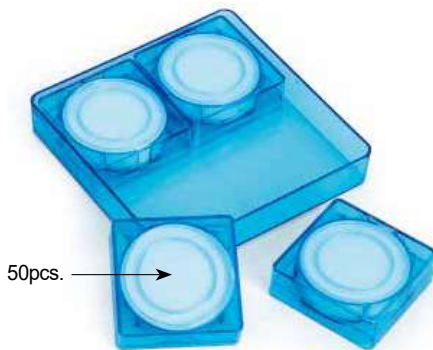

Package Unit : 200pcs./Pk.
(50pcs. × 4 Inner Packs)

- 다공질 형태의 필터, 균일하고 미세한 구멍이 다수 있어 미생물이나 미립자 포집에 적합
- When Choosing a Filter Membrane according to the Application, the Chemical Compatibility Must be Considered.

(1) MCE(Mixed Cellulose Ester) Membrane Filter, for Filtration of Aqueous Solution

- **Very Suitable for Biological Filtration** * Mixed Cellulose Acetate and Nitro Cellulose
- * Protein Solution Filtration Microbiological Analysis Particle Removal and Clarification

<L1>

Filter Type & Pore Size(μ m)	Water Affinity	① Sterile		② Non-Sterile	
		Cat. No.	Pk. Price, ₩	Cat. No.	Pk. Price, ₩
MCE, 0.22 μ m	Hydrophilic	DH.Fil3001	200ea 99,930	DH.Fil3003	200ea 32,770
MCE, 0.45 μ m	Hydrophilic	DH.Fil3002	200ea 99,930	DH.Fil3004	200ea 32,770

(2) Nylon(Polyamide) Membrane Filter, for Filtration of Alkaline Solutions

- **For Water and Solvent-based Sample Filtration**
- * Good Chemical Compatibility with Esters, Bases and Alcohol
- * Removal of Microorganisms and Organic Solvents

Filter Type & Pore Size(μ m)	Water Affinity	① Sterile		② Non-Sterile	
		Cat. No.	Pk. Price, ₩	Cat. No.	Pk. Price, ₩
Nylon, 0.22 μ m	Hydrophilic	DH.Fil3005	200ea 99,930	DH.Fil3007	200ea 51,830
Nylon, 0.45 μ m	Hydrophilic	DH.Fil3006	200ea 99,930	DH.Fil3008	200ea 51,830

(3) PES(Polyethersulfone) Membrane Filter, for Low Protein Adsorption

- **Used for Ready-to-use Sterile Filter Devices; Sterilization of Buffers, Tissue Culture Media, Supplements**
- * Drug and Protein Adsorption in Pharmaceutical Filtration Applications
- * Broad Chemical Compatibility

Filter Type & Pore Size(μ m)	Water Affinity	① Sterile		② Non-Sterile	
		Cat. No.	Pk. Price, ₩	Cat. No.	Pk. Price, ₩
PES, 0.22 μ m	Hydrophilic	DH.Fil3009	200ea 99,930	DH.Fil3011	200ea 51,830
PES, 0.45 μ m	Hydrophilic	DH.Fil3010	200ea 99,930	DH.Fil3012	200ea 51,830

(4) PTFE(Polytetrafluorethylene) Membrane Filter, Hydrophilic/Hydrophobic, Filtration of Highly Corrosive Water-soluble Chemicals

- **Highly Corrosive Chemicals Strong Chemical Compatibility, Used to Filter that Samples will Damage other Syringe Materials** * Good Chemical and Temperature Compatibility
- * Suitable for Filtering Gas(for Hydrophobic) or Organic Solvent

Filter Type & Pore Size(μ m)	Water Affinity	① Sterile		② Non-Sterile	
		Cat. No.	Pk. Price, ₩	Cat. No.	Pk. Price, ₩
PTFE, 0.22 μ m	Hydrophilic	DH.Fil3013	200ea 119,890	DH.Fil3017	200ea 66,620
	Hydrophobic	DH.Fil3014	200ea 119,890	DH.Fil3018	200ea 66,620
PTFE, 0.45 μ m	Hydrophilic	DH.Fil3015	200ea 119,890	DH.Fil3019	200ea 66,620
	Hydrophobic	DH.Fil3016	200ea 119,890	DH.Fil3020	200ea 66,620

(5) PVDF(Polyvinylidene Fluoride) Membrane Filter, Hydrophilic/Hydrophobic, Solvent & Air & Gas Filtration

- **Remove Impurities such as Macromolecules, Bacteria, and Sediment**
- * With Excellent Heat Resistance and Oxidation Resistance, It has a Very Wide Range of Applications
- * Chemical Compatibility even to Corrosive Acids and Alcohol

Filter Type & Pore Size(μ m)	Water Affinity	① Sterile		② Non-Sterile	
		Cat. No.	Pk. Price, ₩	Cat. No.	Pk. Price, ₩
PVDF, 0.22 μ m	Hydrophilic	DH.Fil3021	200ea 113,220	DH.Fil3025	200ea 59,220
	Hydrophobic	DH.Fil3022	200ea 113,220	DH.Fil3026	200ea 59,220
PVDF, 0.45 μ m	Hydrophilic	DH.Fil3023	200ea 113,220	DH.Fil3027	200ea 59,220
	Hydrophobic	DH.Fil3024	200ea 113,220	DH.Fil3028	200ea 59,220

Wisdom Syringe Filter, MCE · Nylon · PES · PTFE · PVDF, Hydrophilic/Hydrophobic, 0.22 & 0.45 μm, φ 13/25mm NEW

With PP Housing Shell, Ideal for Sample Purification, Sterile & Non-sterile, 시린지 필터, 멸균 & 비멸균

NEW



(1) ~ (5) Syringe Filter, φ 13/25mm

- 시린지에 장착하여 시료 정화에 이상적이며 화학적 호환성을 고려하여 다양한 필터 선택 가능
- **When Choosing a Filter Syringe according to the Application, the Chemical Compatibility Must be Considered.**
- * Processing Amount : Less than 10ml for φ 13mm, Less than 100ml for φ 25mm
- * Max. Operating Pressure/Temperature : 3.5bar (350kPa, 50psi) / 55 °C (131 °F) for φ 13mm, 100 °C (212 °F) for φ 25mm

(1) MCE(Mixed Cellulose Ester) & Nitro Cellulose Syringe Filter, for Biological Filtration

- **Protein Solution Filtration Microbiological Analysis Particle Removal and Clarification**
- * Used for Water Injection, Large infusion and Pre-crystallization Solution of Particles and Bacteria Filtration, Antibiotics, Vaccine Serum and Tissue Culture Fluid Filtration

<L1>

Filter Type	Pore Size(μm) & Diameter	Water Affinity	① Sterile, Individual Package		② Non-Sterile, Bulk Package	
			Cat. No.	Pk. Price, ₩	Cat. No.	Pk. Price, ₩
MCE	0.22μm, φ 13mm	Hydrophilic	DH.Fil3031	100ea 66,620	DH.Fil3035	100ea 18,200
	0.22μm, φ 25mm	Hydrophilic	DH.Fil3032	100ea 93,260	DH.Fil3036	100ea 33,680
	0.45μm, φ 13mm	Hydrophilic	DH.Fil3033	100ea 66,620	DH.Fil3037	100ea 18,200
	0.45μm, φ 25mm	Hydrophilic	DH.Fil3034	100ea 93,260	DH.Fil3038	100ea 33,680



Fitting on a Standard Syringe

(2) Nylon(Polyamide) Syringe Filter, for Alkaline Solutions

- **For Water and Solvent-based Sample Filtration** * Good Chemical Compatibility with Esters, Bases and Alcohol
- * Removal of Microorganisms and Organic Solvents

Filter Type	Pore Size(μm) & Diameter	Water Affinity	① Sterile, Individual Package		② Non-Sterile, Bulk Package	
			Cat. No.	Pk. Price, ₩	Cat. No.	Pk. Price, ₩
Nylon	0.22μm, φ 13mm	Hydrophilic	DH.Fil3039	100ea 66,620	DH.Fil3043	100ea 18,200
	0.22μm, φ 25mm	Hydrophilic	DH.Fil3040	100ea 93,260	DH.Fil3044	100ea 34,130
	0.45μm, φ 13mm	Hydrophilic	DH.Fil3041	100ea 66,620	DH.Fil3045	100ea 18,200
	0.45μm, φ 25mm	Hydrophilic	DH.Fil3042	100ea 93,260	DH.Fil3046	100ea 34,130



Fitting on a Standard Syringe, φ 25mm

(3) PES(Polyethersulfone) Syringe Filter, for Low Protein Adsorption

- **Used for Ready-to-use Sterile Filter Devices; Sterilization of Buffers, Tissue Culture Media, Supplements**
- * Drug and Protein Adsorption in Pharmaceutical Filtration Applications * Broad Chemical Compatibility

Filter Type	Pore Size(μm) & Diameter	Water Affinity	① Sterile, Individual Package		② Non-Sterile, Bulk Package	
			Cat. No.	Pk. Price, ₩	Cat. No.	Pk. Price, ₩
PES	0.22μm, φ 13mm	Hydrophilic	DH.Fil3047	100ea 66,620	DH.Fil3051	100ea 28,140
	0.22μm, φ 25mm	Hydrophilic	DH.Fil3048	100ea 93,260	DH.Fil3052	100ea 40,710
	0.45μm, φ 13mm	Hydrophilic	DH.Fil3049	100ea 66,620	DH.Fil3053	100ea 28,140
	0.45μm, φ 25mm	Hydrophilic	DH.Fil3050	100ea 93,260	DH.Fil3054	100ea 40,710



Sterile Individual Package

(4) PTFE(Polytetrafluorethylene) Syringe Filter, for Filtration of Highly Corrosive Water-soluble Chemicals

- **Highly Corrosive Chemicals Strong Chemical Compatibility, Used to Filter that Samples will Damage other Syringe Materials** * Good Chemical and Temperature Compatibility
- * Suitable for Filtering Gas(for Hydrophobic) or Organic Solvent

Filter Type	Pore Size(μm) & Diameter	Water Affinity	① Sterile, Individual Package		② Non-Sterile, Bulk Package	
			Cat. No.	Pk. Price, ₩	Cat. No.	Pk. Price, ₩
PTFE	0.22μm, φ 13mm	Hydrophobic	DH.Fil3055	100ea 74,020	DH.Fil3059	100ea 20,930
	0.22μm, φ 25mm	Hydrophobic	DH.Fil3056	100ea 111,000	DH.Fil3060	100ea 31,860
	0.45μm, φ 13mm	Hydrophobic	DH.Fil3057	100ea 74,020	DH.Fil3061	100ea 20,930
	0.45μm, φ 25mm	Hydrophobic	DH.Fil3058	100ea 111,000	DH.Fil3062	100ea 31,860



Non-Sterile, Bulk Package
100ea/Pk.

(5) PVDF(Polyvinylidene Fluoride) Syringe Filter, for Solvent · Air · Gas Filtration

- **Remove Impurities such as Macromolecules, Bacteria, and Sediment**
- * With Excellent Heat Resistance and Oxidation Resistance, It has a Very Wide Range of Applications
- * Chemical Compatibility even to Corrosive Acids and Alcohol

Filter Type	Pore Size(μm) & Diameter	Water Affinity	① Sterile, Individual Package		② Non-Sterile, Bulk Package	
			Cat. No.	Pk. Price, ₩	Cat. No.	Pk. Price, ₩
PVDF	0.22μm, φ 13mm	Hydrophobic	DH.Fil3063	100ea 74,020	DH.Fil3067	100ea 25,510
	0.22μm, φ 25mm	Hydrophobic	DH.Fil3064	100ea 109,230	DH.Fil3068	100ea 36,400
	0.45μm, φ 13mm	Hydrophobic	DH.Fil3065	100ea 74,020	DH.Fil3069	100ea 25,510
	0.45μm, φ 25mm	Hydrophobic	DH.Fil3066	100ea 109,230	DH.Fil3070	100ea 36,400

Articles	Cat. No	Description
----------	---------	-------------

filtratech® Venting Filters, with PTFE Membrane, Hydrophobic, Sterile, Autoclavable, 0.22~ 0.45 μ m, ϕ 47mm NEW
 Ideal for Chemically Aggressive Solutions, Hose Barb Connector, for ID ϕ 6~12mm Tubing, <France-made>, **벤팅 필터, 멸균 개별포장**



- 일반적으로 공기 및 가스 등 정화에 적합
- 미생물 배양 시 PTFE 멤브레인 필터를 통해 내부 또는 외부로부터 미생물 등 오염 방지
- Suitable for Sterilization of Air and Gas, Cleaning Acids, Alkalis and Organic Solvents, Venting Purposes
- Used in Fermenters and Bioreactors
- * Ideal for Pharmaceutical, Biotechnology
- * Venting of Autoclaves
- * with Specific Connections That are Adapted for the Direct Connection to Flexibles.
- * Suitable for Flexible Tubing with id. 6~12mm
- * High Flow Rates
- * Sterile Individual Package
- * without Bottle, Cap and Hose : Order Separately



Filter Type	Pore Size(μ m)	Diameter(mm)	Bubble point	Cat. No.	Pk.	Price, ₩
PTFE	0.22 μ m	ϕ 47mm	1.2	FL.FE47.PT22S	25ea	395,220
	0.45 μ m		0.8	FL.FE47.PT45S	25ea	395,220

, Special Filters



filtratech® Phase Separating Paper, Hydrophobic with Silicone Impregnation, ϕ 90~150mm
 Ideal for the Separation of Aqueous Solutions, Water-repellent, <France-made>, **분액 여과지 NEW**

- 유기 용액에서 수용액을 분리하는데 적합
 - * Ideal for the separation of Aqueous Solutions from Organic Solutions
 - * It Allows a Quick Separation of Elements and Replaces the Use of a Separating Funnel
 - * Thick. 0.17mm
- | FL.FS92.A090 | Phase Separating Paper, Hydrophobic, ϕ 90 | Pk. | Price, ₩ |
|--------------|--|-------|----------|
| FL.FS92.A110 | , ϕ 110 | 100ea | 44,220 |
| FL.FS92.A125 | , ϕ 125 | 100ea | 61,240 |
| FL.FS92.A150 | , ϕ 150 | 100ea | 75,580 |
| | | 100ea | 108,880 |
- <L1>



filtratech® Nitrogen Free Filter Paper, Slow Filtration, Sheets & Disc-Type, 10x10cm, ϕ 90~150mm
 Ideal for the Determination of Nitrogen Content, <France-made>, **니트로젠 프리 여과지 NEW**

- 철강 및 철골의 질소함량 분석에 적합
 - * Ideal for the Determination of Nitrogen Content in Steel and Iron Rough
- | Weight (g/m ²) | Thickness (mm) | Filtration Speed (sec) | Nitrogen Content |
|----------------------------|----------------|------------------------|---------------------------|
| 85 | 0.17 | 650 | ~0.05 mg / disc of 110 mm |
- <L1>

- (1) Sheet-Type
- | FL.FS96.F1010 | Filter Paper, Nitrogen Free Sheet-Type, 10x10cm | Pk. | Price, ₩ |
|---------------|---|-------|----------|
| | | 100ea | 35,870 |
- (2) Disc-Type
- | FL.FS96.A090 | Filter Paper, Nitrogen Free Disc-Type, ϕ 90mm | Pk. | Price, ₩ |
|--------------|--|-------|----------|
| FL.FS96.A110 | , ϕ 110mm | 100ea | 19,440 |
| FL.FS96.A150 | , ϕ 150mm | 100ea | 25,430 |
| | | 100ea | 44,790 |



filtratech® Sugar Industry Filter Paper, Fast/Very Fast Filtration, Creped Surface, ϕ 110~240mm
 Ideal for Clarification to Sugar Cane, <France-made>, **여과지, 설탕 수크로스 분석용 NEW**

- 용액의 당분 양 분석에 적합
 - * Offer a Fast Filtration or a Very Filtration for the Clarification of Cane Sugar Juice
 - * Ideal for Efficient Saccharimetric Tests of after Lead Acetate Addition
- | FL.FS91.A110 | Filter Paper, Sugar Industry, ϕ 110 | Pk. | Price, ₩ |
|--------------|--|-------|----------|
| FL.FS91.A125 | , ϕ 125 | 100ea | 6,560 |
| FL.FS91.A150 | , ϕ 150 | 100ea | 8,330 |
| FL.FS91.A185 | , ϕ 185 | 100ea | 11,680 |
| FL.FS91.A240 | , ϕ 240 | 100ea | 12,950 |
| | | 100ea | 23,760 |
- <L1>



Powder Free Finger Cot, Class 1000, Multiple washed, Made of High-quality Latex NEW
 Ideal for Clean Room, Electronic Industry(PCB, BLU) & Lab, 크린룸용 라텍스 글무, 정전기 방지

- 고품질 Latex로 제작하여 인장강도가 강하며 Allergy 발생을 최소화
- 전자부품, PCB, BLU 등 미세한 작업이 필요한 공정 또는 이물에 대한 제품 보호가 필요한 작업장에 적합
- * Manufactured from High-quality Latex with Strong Tensile Strength and Minimized Allergy Occurrence
- * Powder Free Type * Suitable for Sensitive Tasks : Electronics, Computer, Laboratory
- * Roll-type : Easy to wear * Anti-static

<L1>

(1) Powder-free with Rim

DH.Fin6001 Powder-Free Finger Cot, Roll-type, Small
DH.Fin6002 , Medium

Pk. Price, ₩	Cs. Price, ₩
1000ea 11,310	30pk 328,560
1000ea 11,310	30pk 328,560

(2) Powder-free without Rim

DH.Fin6006 Powder-Free Finger Cot, Unroll-type, Small
DH.Fin6007 , Medium

Pk. Price, ₩	Cs. Price, ₩
1000ea 11,890	30pk 345,540
1000ea 11,890	30pk 345,540



Articles	Cat. No	Description
----------	---------	-------------



PP Filter Flask, with Side-arm, for Tubing id ϕ 7~9mm, 500~1500ml NEW
 Autoclavable, Flexible Hose, Prevent Tipping with 45° angle, -10°C + 125/140°C, PP 여과 플라스크, 일체형

■ 7~9mm 호스를 연결하기 위한 가지가 달린 플라스크
 * Side Arm : for Tube id ϕ 7~9mm Flexible Hose.

SL.Fla3091 Filter Flask, 500ml , ϕ 110×h200, Side Arm Size 8mm, Neck id 32.5mm
SL.Fla3092 , 1000ml, ϕ 130×h210, , Neck id 36.3mm
SL.Fla3093 , 1500ml, ϕ 160×h290, , Neck id 46.7mm

<L2>	
Ea.	Price, ₩
	45,600
	56,610
	59,740

SAUTER® [d] 0.005~0.2N, Max.10~500N Digital Force Gauge Set, for Measuring Push- & Pull-force, with Standard Attachments
 Measuring Unit : N(Newton) · lb · kg · oz, with Peak Hold Function & Turnable Display, Factory Calibration Available, **디지털 포스케이지 세트 NEW**

NEW



10~500N Digital Force Gauge

■ Supplied by SAUTER® in Germany

- * Turnable Display : Automatic Direction Identification
- * Peak-Hold function to Capture Peaks or Track Function Mode for a Continuous Measurement Indication
- * Can be mounted on all SAUTER Test Stand
- * Measuring Unit : N(Newton) · lb · kg · oz * 1N=0.102kgf, 1kgf=9.8N * Auto-Power-Off
- * **Complete Set with** : ① Force Gauge, ② Power Supply, ③ Card board Packaging, ④ Standard Attachments, ⑤ 6 × 1.5V AA Batteries
- * Can Use Standard Attachments for Piercing, Tearing, Pressing or Hooking during ② Compression or ③ Tension Test as well as Use ③ Where Objects are Difficult to Access
- * Secure Operability due to the Ergonomic Design

Specifications

- * Precision : 0.5 % of [Max]
- * Overload Protection : 200 % of [Max]
- * Ready for use : Batteries included, 6 × 1.5V AA
- * Internal Measuring Frequency : 1000 Hz
- * Dimensions w195 × d82 × h35 mm
- * Net weight approx. 0.72 kg * Thread : M8

※ If you want to get optional Factory Calibration Certificate, please order the Certificate Separately when you order the Force Gauge !

<L1>



Incl. Standard Attachments



(1) Tensiometer Kit (Option)

Cat. No.	Measuring Range Max N	Readout d N	Set. / Price, ₩	Optional Calibration Certificate			
				Tensile Force		Tensile / Compressive Force	
				Cat. No.	Ea. / Price, ₩	Cat. No.	Ea. / Price, ₩
SA.FK10	0~10	0.005	439,720	SA.961.1610	253,580	SA.961.3610	460,190
SA.FK25	0~25	0.01	439,720	SA.961.1610	253,580	SA.961.3610	460,190
SA.FK50	0~50	0.02	439,720	SA.961.1610	253,580	SA.961.3610	460,190
SA.FK100	0~100	0.05	439,720	SA.961.1610	253,580	SA.961.3610	460,190
SA.FK250	0~250	0.1	439,720	SA.961.1610	253,580	SA.961.3610	460,190
SA.FK500	0~500	0.2	439,720	SA.961.1610	253,580	SA.961.3610	460,190
SA.FK.A02	Option ; (1) Tensiometer Kit, max. 1000N, for Testing like Cables, Threads, Wires &c. (up to ϕ5mm)						554,110

SAUTER® [d] 0.001~0.1N, Max.5~500N Universal Digital Force Gauge Set, for Tension & Compression, with Data Interface RS-232
 Measuring Unit : N(Newton) · lb · kg · oz, with Peak Hold Function & Turnable Display, Factory Calibration Available, **유니버설 디지털 포스케이지 세트 NEW**

NEW



5~500N Universal Digital Force Gauge

■ Supplied by SAUTER® in Germany

- * Turnable Display with Backlight
- * with Data Interface RS-232 & Robust Carrying Case
- * Peak-Hold Function to Capture Peaks or Track Function Mode for a Continuous Measurement Indication
- * Measuring with Tolerance Range (Limit-setting Function)
- * Internal Memory for up to 10 Measurement Values
- * Mini Statistics Kit : Calculates the Average Result from up to 10 Stored Measured Values, as well as min., max., n
- * Delivered in a Robust Carrying Case
- * **Complete Set with** : ① Force Gauge with Rechargeable Battery, ② Carrying Case, ③ Charger, ④ Standard Attachments
- * Can Use Standard Attachments for Piercing, Tearing, Pressing or Hooking during ② Compression or ③ Tension Test as well as ③ Where Objects are Difficult to Access
- * Measuring Unit : N(Newton) · lb · kg · oz * 1N=0.102kgf, 1kgf=9.8N
- * Auto-Power-Off
- * Can be mounted on all SAUTER Test Stands

Specifications

- * High Resolution : up to 10,000 points (Total Measuring Range)
- * Internal Measuring Frequency : 2000 Hz
- * Dimensions w66 × d36 × h230 mm
- * Rechargeable Battery Pack Integrated, Standard, Operating Time up to 12h without Backlight, Charging Time approx. 4h
- * Overload Protection : 150 % of [Max]
- * Precision : 0.5 % of [Max]
- * Thread : M6
- * Net Weight approx. 0.64 kg

※ If you want to get optional Factory Calibration Certificate, please order the Certificate Separately when you order the Force Gauge !

<L1>



Incl. Standard Attachments



with Carrying Case

Cat. No.	Measuring Range Max N	Readout d N	Set. / Price, ₩	Optional Calibration Certificate			
				Tensile Force		Tensile / Compressive Force	
				Cat. No.	Ea. / Price, ₩	Cat. No.	Ea. / Price, ₩
SA.FH5	0~5	0.001	809,060	SA.963.161	311,240	SA.963.361	564,820
SA.FH10	0~10	0.005	809,060	SA.963.161	311,240	SA.963.361	564,820
SA.FH50	0~50	0.01	809,060	SA.963.161	311,240	SA.963.361	564,820
SA.FH100	0~100	0.05	809,060	SA.963.161	311,240	SA.963.361	564,820
SA.FH500	0~500	0.1	809,060	SA.963.161	311,240	SA.963.361	564,820
KE.YKB.01	Option ; Standard Thermal Printer, 0.75 lines/sec, 165 × 140 × h50 mm						600,500



(1) for Vertical and Horizontal Use

(2) for Vertical Use

SAUTER® Manual Test Stand, for Force Gauges up to 500N(Newton), with Digital Length Measurement For Vertical- & Horizontal-use, without Force Gauge, 포스게이지용 수동형 스탠드, 케이지 별도 **NEW**

■ **Supplied by SAUTER® in Germany**

- * High Level of Security with Repeated Measurements
- * Large Base Plate with High Versatility of Fastening Objects
- * Can be used for Force Gauges up to 500 N (Not Included) * Hook with M6 Thread as Standard
- * Digital Length Meter : a) Measuring Range: Max. 100mm (TVPL) or 200mm (TVL), b) Readout: 0.01 mm, c) Zero setting possible, d) Pre-length can be set manually

(1) for Vertical and Horizontal Use, with Crank Handle

■ **For Highly Accurate Tensile and Compressive Force Measurements**

- * Max Travel from Base Plate : 297 mm
- * Travel Distance per Knob Rotation (stroke per one turn): 3.1 mm
- * Overall Dimensions w151 × d234 × h465 mm * Net Weight approx. 8.3 kg

<L1>

Ea. Price, ₩

SA.TVL Test Stand, for Force Gauges up to 500N, for Vertical and Horizontal Use, Crank Handle type

650,780

(2) for Vertical Use

■ **For Compressive Force Measurements**

- * Provides Quick and Consistent Testing
- * Provides Maximum Versatility and Precise Measuring Results
- * Slide Construction for Distance Measurement * Maximum Carriage Height above Base Plate : 318 mm
- * Max Travel Distance with One Stroke : 78 mm * Overall Dimensions w150 × d233 × h420 mm
- * Net Weight approx. 10.5 kg

Ea. Price, ₩

SA.TVPL Test Stand, for Force Gauges up to 500N, for Vertical Use

650,780

SAUTER® Premium Analog Motorised Vertical Table-top Test Stand, for Force Gauges up to 500N(Newton), with Electric Motor With Automatic or Manual Process Mode, 포스게이지용 자동 & 수동 스탠드, 케이지 별도 **NEW**



Motorised Test Stand
※ Not Include a Force Gauge

■ **Supplied by SAUTER® in Germany**

■ **Motorised Test Stand for Tension and Compression Tests**

- * Table-top Design for Comfortable Operation * Robust Design for Durable use
- * Easy-to-access Safety Switch-off * Automatic or Manual Operation Mode
- * Upper and Lower End Point can be Set Individually
- * Suitable in the Field of Rubber & Plastic Products, Light Industry & Textile, Construction of Frame, Complex Material, Wires & Cables, Automobile Components, Engine and Scientific Research.
- * Package includes Test Stand, M6 Inner-hexagonal Spanner, 230V Power wire, M6 Clamp and Operation Manual
- * Net Weight approx. 25 kg * Rate Flow : 1.5 A
- * Fuse of Main Circuit : 3A * Work Voltage : Single-phase 220V

Ordering Information

<L1>

Cat. No.	Measuring Range Max N	Speed Range (mm/min)	Speed Accuracy	Max. Travelling Distance	Dimensions w × d × h(mm)	Ea. Price, ₩
SA.TVO500N300	0~500	15-300	2% of [Max]	300mm	236 × 428 × 570	3,380,960
SA.AFH.FAST	Option ; Force-time Data Transfer Software, for Graphical Representation on the PC and Data Transfer to Microsoft Excel®					216,030
SA.LB.A02	Option ; Mounting the Length Measuring Device onto a SAUTER Stand at the factory ※ This Option must be Ordered with the Stand !					356,890

Hammacher® Premium Watchmaker Fine-tip Forceps, L110mm, *Medicaluse approved* **NEW**
 With Straight- & Curved-type, Stainless-steel 420, <Germany-made>, 프리미엄 정밀팁 포셉/핀셋, 독일제 의료용



Medicaluse

■ Germany-made 프리미엄급; 의료용 포셉/핀셋

HA.HSC818.11 (1) Watchmaker Forceps, Stainless-steel, Straight, L110mm
 HA.HSC819.10 (2) , Curved, L110mm

Ea.		Price, ₩
		12,010
		12,930

<M1>

Hammacher® Premium Dressing/Thumb Forceps, Wironit™ & Rustproof Stainless-steel, *Medicaluse approved*
 120~300mm, with Blunt/Ridged-Tip, <Germany-made>, 프리미엄 표준 드레싱 포셉/핀셋, 독일제 의료용

Medicaluse



(1) L120~250mm Wironit™ SS



(2) L145~300mm Rustproof SS

■ Germany-made 프리미엄급; 의료용 드레싱 포셉/핀셋, Wironit™ 특수스텐 & Rustproof 스텐제품

(1) L120~250mm Wironit™ SS, 의료용, 비자성/비부식 특수스텐

* Wironit™ Special Stainless-steel of 18/10 Cr-Ni
 ; Non-magnetic, Rust-free, Excellent Resistance of Acid / Chemicals / Heat

HA.HWC050.12 Dressing/Thumb Forceps, SS Straight, Blunt/Ridged-Tip, L120mm
 HA.HWC051.13 , L130mm
 HA.HWC052.14 , L145mm
 HA.HWC053.16 , L160mm
 HA.HWC054.18 , L180mm
 HA.HWC055.20 , L200mm
 HA.HWC056.25 , L250mm

Ea.		Price, ₩
		33,980
		35,520
		40,750
		41,520
		45,820
		46,750
		52,570

<M1>

(2) L145~300mm Rustproof SS, 의료용, 비부식 스텐 **NEW**

* Surgical Stainless-steel 420 : Rust-proof, High-Strength/Hardness, Chemical Resistance

HA.HSC054.14 Dressing/Thumb Forceps, SS, Straight, Blunt/Ridged-Tip, L145mm
 HA.HSC056.16 , L160mm
 HA.HSC058.18 , L180mm
 HA.HSC060.20 , L200mm
 HA.HSC062.25 , L250mm
 HA.HSC064.30 , L300mm

Ea.		Price, ₩
		16,620
		17,680
		22,450
		24,620
		29,820
		32,290

NEW
Medicaluse

Dressing/Thumb Forceps, Stainless-steel 410, L125~250mm, *Medicaluse*
 With Blunt & Ridged-Tip, 표준 드레싱 포셉/핀셋, 의료용, 비부식

■ Stainless-steel 410 : 비부식, 고강도, 고경도, 내약품성
 ■ Rust-proof, High-Strength/Hardness, Chemical Resistance

DM.04.1010 Dressing/Thumb Forceps, SS, Blunt & Ridged-Tip, L125mm
 DM.04.1011 , L140mm
 DM.04.1013 , L180mm
 DM.04.1014 , L200mm
 DM.04.1015 , L250mm

Ea.		Price, ₩
		9,530
		9,650
		9,880
		10,000
		10,120

<M1>

Hammacher® Premium Microscopic Dressing Forceps, Wironit™ Non-magnetic/Rust-free Stainless-steel, *Medicaluse approved*
 Very Delicate, with Ridged-Tip, L105~130mm, <Germany-made>, 프리미엄 마이크로스코픽 포셉/핀셋, 독일제 의료용, 비자성/비부식 특수스텐



Medicaluse

■ Germany-made 프리미엄급 의료용 드레싱 포셉/핀셋, Wironit™ 특수스텐(18/10 크롬·니켈) 제품;
 비자성, 비부식, 내산성 / 내약품성 / 내열성 우수 ■ 드레싱용
 ■ Wironit™ Special Stainless-steel of 18/10 Cr-Ni
 ; Non-magnetic, Rust-free, Excellent Resistance of Acid / Chemicals / Heat

(1) Straight-type, L105~130 mm

HA.HWC070.10 Dressing Forceps, Stainless-steel, Straight, with Pin, L105mm **New**
 HA.HWC072.11 , L115mm **New**
 HA.HWC074.13 , L130mm

Ea.		Price, ₩
		41,210
		43,660
		42,890

<M1>

(2) Curved-type, L105~130 mm

HA.HWC071.10 Dressing Forceps, Stainless-steel, Curved, with Pin, L105mm **New**
 HA.HWC073.11 , L115mm **New**
 HA.HWC075.13 , L130mm

Ea.		Price, ₩
		42,740
		44,590
		44,590

Articles	Cat. No	Description
----------	---------	-------------

Hammacher® Premium Cotton/Dressing College · Maeriam Forceps, L150~160mm, *Medicaluse approved* NEW
 With Serrated Handle · Pin, Sharp/Ridged Tip, Curved-type, Stainless-steel 420, <Germany-made>, 프리미엄 콜리지 · 메리엄 포셉/핀셋, 독일제 의료용, 비부식

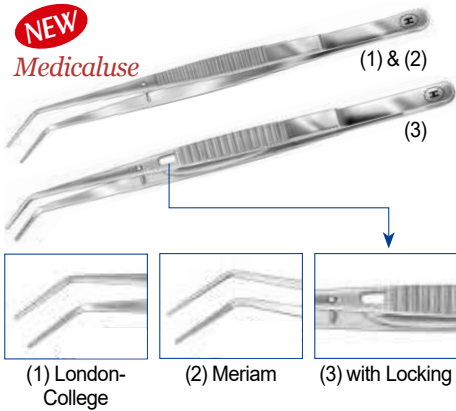

- **Germany-made** 프리미엄급; 의료용 코튼 · 드레싱 포셉 / 핀셋, 비부식, 고강도, 고경도, 내약품성
- **Surgical Stainless-steel 420 : Rust-proof, High-Strength/Hardness, Chemical Resistance** <M1>
- * Used to Grasp or Transfer Materials

Ea.	Price, ₩
HA.HSC020.05 (1) Forceps, SS, Sharp/Ridged Tip, London-College, L150mm	13,850
HA.HSC012.05 , L160mm	23,840
HA.HSC021.09 (2) , Meriam, L150mm	15,070
HA.HSC024.09 , L160mm	18,460
HA.HSC031.15 (3) , with Locking, L155mm	35,360

Hammacher® Premium Cotton/Dressing College & Meriam Forceps, Wironit™ Non-magnetic/Rust-free Stainless-steel, *Medicaluse* NEW
 With Smooth Handle · Pin, Sharp/Smooth or Ridged Tips, L150mm, <Germany-made>, 프리미엄 Wironit™ 콜리지 & 메리엄 포셉/핀셋, 의료용, 비자성/비부식 특수스텐

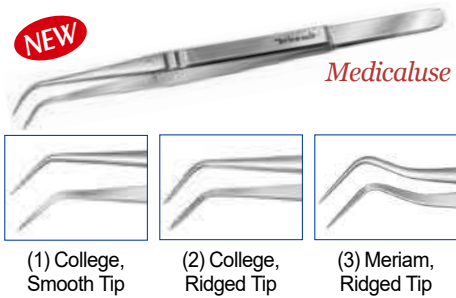

- **Germany-made** 프리미엄급; 의료용 코튼 · 드레싱 포셉 / 핀셋, Wironit™ 특수스텐(18/10 크롬 · 니켈) 제품 ; 비자성, 비부식, 내산성 / 내약품성 / 내열성 우수
- **Wironit™ Special Stainless-steel of 18/10 Cr-Ni ; Non-magnetic, Rust-free, Excellent Resistance of Acid / Chemicals / Heat** <M1>
- * Used to Grasp or Transfer Materials

Ea.	Price, ₩
HA.HWC016.04 (1) Forceps, Stainless-steel, College, Sharp/Smooth Tip, L150mm	31,370
HA.HWC017.05 (2) , Sharp/Ridged Tip, L150mm	32,000
HA.HWC019.12 (3) , Meriam, Sharp/Ridged Tip, L150mm	33,210

Hammacher® Premium Dressing/Tissue Semken & Adson Forceps, L120mm, *Medicaluse approved* NEW
 For Dressing or Grasping Soft Tissue, Very Delicate, SS 420, <Germany-made>, 프리미엄 드레싱 겸 티슈 에디슨 & 샘켄 포셉/핀셋, 독일제 의료용, 비부식

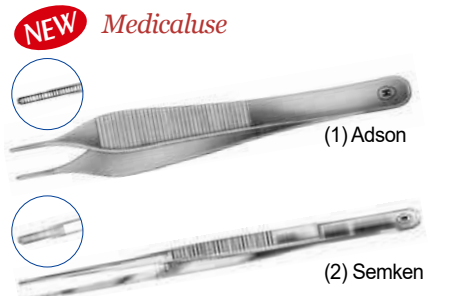

- **Germany-made** 프리미엄급; 의료용 드레싱 · 티슈 포셉 / 핀셋, 비부식, 고강도, 고경도, 내약품성
- **Surgical Stainless-steel 420 : Rust-proof, High-Strength/Hardness, Chemical Resistance** <M1>
- * Used for Wound Dressing and Compressing or Grasping Soft Tissues in Surgical Operation

Ea.	Price, ₩
HA.HSC080.12 (1) Dressing/Tissue Forceps, Stainless-steel, Adson, L120mm	20,910
HA.HSC086.12 (2) , Semken, L120mm	27,520



Graefe Iris Forceps, Stainless-steel 410, L105mm, *Medicaluse* NEW
 With Sharp & Ridged-Tip, Delicate, 그레이프 아이리스 포셉/핀셋, 의료용, 비부식

- **Stainless-steel 410 : 비부식, 고강도, 고경도, 내약품성**
- **Tip이 가늘고 길어 섬세한 작업을 하는데 용이하며, 안과에서 가장 많이 쓰이며 일반 외과에서도 흔하게 사용됨**
- **Rust-proof, High-Strength/Hardness, Chemical Resistance** <M1>
- * Used to Grasp and Hold Tissue during Ophthalmic Procedures

Ea.	Price, ₩
DM.04.1017 Iris Forceps, Stainless-steel, Graefe, Straight, L105mm	3,940

Hammacher® Premium Micro Tissue Adson-Brown Forceps, With 7 × 7 Tips, L120mm, *Medicaluse approved* NEW
 For Soft Tissue, Very Delicate, Stainless-steel 420, <Germany-made>, 프리미엄 마이크로 티슈 에디슨-브라운 포셉/핀셋, 독일제 의료용, 비부식



- **Germany-made** 프리미엄급; 의료용 티슈포셉/핀셋, 비부식, 고강도, 고경도, 내약품성
- **Surgical Stainless-steel 420 : Rust-proof, High-Strength/Hardness, Chemical Resistance** <M1>
- * Used for Grasping Soft Tissues in Surgical Operation

Ea.	Price, ₩
HA.HSC234.12 Micro Tissue Forceps, SS, Adson Brown, L120mm	33,520

Articles

Cat. No

Description

NEW

Medicaluse



1:2 Teethed

Tissue Forceps, Stainless-steel 410, L115~250mm, *Medicaluse* NEW
With 1:2 Teethed Tip, 티슈 포셉/핀셋, 의료용, 비부식

- Stainless-steel 410 : 비부식, 고강도, 고경도, 내약품성
- Rust-proof, High-Strength/Hardness, Chemical Resistance

<M1>

Articles	Description	Ea.	Price, ₩
DM.04.1023	Tissue Forceps, Stainless-steel, 1:2 Teethed Tip, L115mm		9,490
DM.04.1024	, L125mm		9,650
DM.04.1025	, L140mm		9,760
DM.04.1027	, L180mm		10,000
DM.04.1029	, L250mm		10,230

NEW

Medicaluse



Round Ridged Tip

Tissue *Russian* Forceps, Stainless-steel 410, L200 & 250mm, *Medicaluse*
With Round Ridged Tip, 티슈 러시아 포셉/핀셋, 의료용, 비부식 NEW

- Stainless-steel 410 : 비부식, 고강도, 고경도, 내약품성
- 단단한 조직을 잡는데 사용
- Stainless-steel 410 : Rust-proof, High-Strength/Hardness, Chemical Resistance

<M1>

* Ideal for Grasping Dense Tissue

Articles	Description	Ea.	Price, ₩
DM.04.1032	Tissue, Stainless-steel, Russian, Round Ridged Tip, L200mm		23,210
DM.04.1033	, L250mm		23,600

Hammacher® Premium Curved Grasping Forceps, Wironit™ Special Non-Magnetic Stainless-steel, L145mm, *Medicaluse approved*
With Flat- & Round-Tip, for Placing Brackets, <Germany-made>, 프리미엄 곡선 그래스핑 포셉/핀셋, 독일제 의료용, 비부식 NEW

NEW

Medicaluse



- Germany-made 프리미엄급; 비자성, 비부식, 내산성 / 내약품성 / 내열성 우수
- Wironit™ Special Stainless-steel of 18/10 Cr-Ni ; Non-magnetic, Rust-free, Excellent Resistance of Acid / Chemicals / Heat
- * Used to Place Orthodontic Brackets on to the Teeth

<M1>

Articles	Description	Ea.	Price, ₩
HA.HWC530.14	Forceps, Stainless-steel, Curved, L145mm		42,430

Hammacher® Premium Convenient Rubber Coated-tip Forceps, Curved-type, L165mm, *Medicaluse approved* NEW
Ideal for Gripping Smallest Parts, Stainless-steel 420, Autoclavable, Anti-acid / Rustproof, <Germany-made>, 프리미엄 고무 코팅 곡형 포셉, 독일제 의료용

NEW

Medicaluse

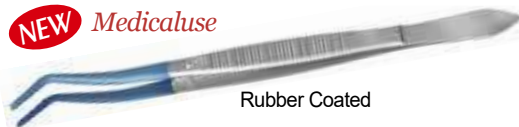

Rubber Coated

- Germany-made 프리미엄급; 고무 코팅 팁이 집기 힘든 작은 물체를 안정감 있게 잡아줌. 130℃ 내열
- * Ideal for Gripping Small Screw or Part bad to be Gripped in the Laboratory
- * Heat Resistant up to 130℃

<M1>

Articles	Description	Ea.	Price, ₩
HA.HSC524.16	Forceps, SS, Curved, Liquid Rubber-coated Tip, L165mm		29,230

Hammacher® Premium Silicone-tip Curved Forceps, with Adjusting Screw 0~17mm, L160mm, *Medicaluse approved* NEW
Ideal for Zirconium Works, Stainless-steel 420, Included 5 Pairs of Replacement Silicone-tip, <Germany-made>, 프리미엄 실리콘 팁 곡형 포셉, 독일제 의료용

NEW

Medicaluse

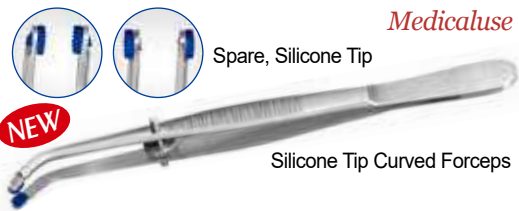

Spare, Silicone Tip

Silicone Tip Curved Forceps

- Germany-made 프리미엄급; 양방향 교체 가능한 실리콘 부분이 안정감있게 잡아줌
- * Used for Zirconium Crown Holder · Zirconium Cap Holder · Zirconium Scaffold Holder
- * Silicone Plates for Interior and Exterior Application, Individually Adjustable
- * Included 5 Pairs of Replacement Silicone-tip ; Non-Autoclavable

<M1>

Articles	Description	Ea.	Price, ₩
HA.HSL549.16	Forceps, Stainless-steel, Curved, Silicone-tip, L160mm		115,280
HA.HSL550.99	Spare; Replacement Silicone-tip, 1 pair		5,230

Articles	Cat. No	Description
----------	---------	-------------

Hammacher® Premium Haemostatic Forceps/Tubing Clamp, with Serrated Clamp Heads, L120~140mm, *Medicaluse approved* **NEW**
 Crile · Halsted · Kelly · Mosquito-Forceps, Stainless-steel 410, 프리미엄 지혈 겸자 포셉 및 튜빙 클램프 겸용, 독일제 의료용 & 랩 겸용

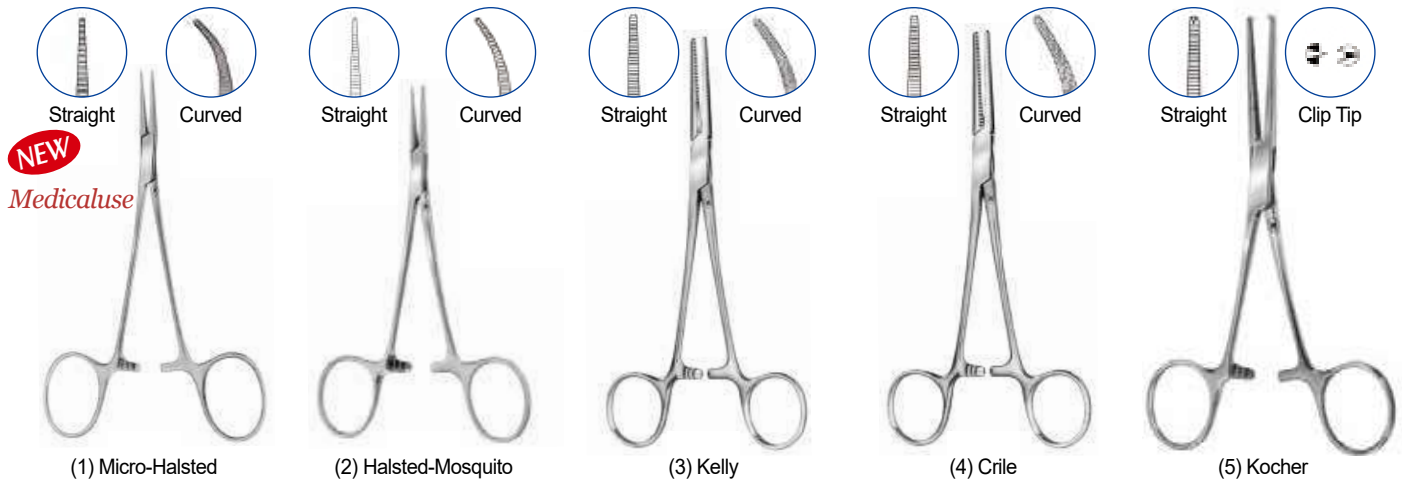

- Germany-made 프리미엄급; 의료용 지혈 겸자 / 포셉 / 핀셋, 비부식, 고강도, 고경도, 내약품성
- 용도 : 조직이나 혈관을 잡거나 조작, 압박, 절단, 결합, 또는 호스나 튜브를 고정시켜 기밀을 유지하는 등 다목적 기구
- 격자로 된 홈이 있는 팁이 미끄러지지 않게 잡도록 도와주고, 가위형 손잡이로 간편하게 고정시키거나 잡을 수 있음
- Stainless-steel 410 : Rust-proof, High-Strength/Hardness, Chemical Resistance

(1) Micro-Halsted Forceps, L125mm, 마이크로-할스테드 포셉

* 작은 섬유조직을 잡을 때 유용 * Very Delicate model

	Ea. Price, ₩
HA.HSE016.12 Forceps, SS, Micro-Halsted, Straight, L125mm	41,520
HA.HSE017.12 , Curved, L125mm	42,890

(2) Halsted-Mosquito Forceps, L120mm, 할스테드-모스키토 포셉

* 작은 섬유조직을 잡을 때 유용

	Ea. Price, ₩
HA.HSE022.12 Forceps, SS, Halsted-Mosquito, Straight, L120mm	38,130
HA.HSE023.12 , Curved, L120mm	39,680

(3) Kelly Forceps, L140mm, 켈리 포셉

* 비교적 큰 조직을 잡을 때 유용

	Ea. Price, ₩
HA.HSE044.14 Forceps, SS, Kelly, Straight, L140mm	44,880
HA.HSE045.14 , Curved, L140mm	45,820

(4) Crile Forceps, L140mm, 크리얼 포셉

* 비교적 큰 조직을 잡을 때 유용

	Ea. Price, ₩
HA.HSE048.14 Forceps, SS, Crile, Straight, L140mm	44,590
HA.HSE049.14 , Curved, L140mm	45,820

(5) Tissue Kocher Forceps, with Clip Tip 1:2, L160mm, 코카 포셉

* 비교적 크고 단단한 조직을 잡을 때 유용

	Ea. Price, ₩
HA.HSE088.16 Tissue Forceps, SS, Kocher, Straight, with Clip Tip 1:2, L160mm	54,430

Hartman Hemostatic Forceps/Tubing Clamp, with Serrated Clamp Head, L105mm, *Medicaluse* **NEW**

Straight- & Curved-type, Stainless-steel 410, *하트만* 지혈겸자 포셉 및 튜빙 클램프 겸용, 의료용 & 랩겸용, 비부식

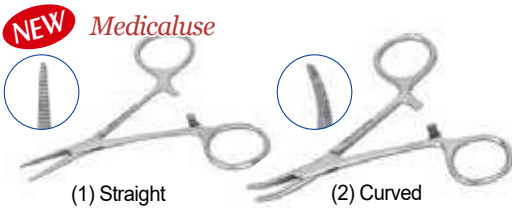

- Stainless-steel 410 : 비부식, 고강도, 고경도, 내약품성
- 진료 시 조직이나 혈관을 잡거나 조작, 압박, 절단, 결합 또는 호스나 튜브를 고정시켜 기밀을 유지하는 등 다목적 기구
- Stainless-steel 410 : Rust-proof, High-Strength/Hardness, Chemical Resistance

* Used to Clamp Blood Vessel and Hold Tissue or Control the Flow of Liquids or Gases Through Flexible Tubing

	Ea. Price, ₩
DM.04.1035 (1) Forceps, Hartman, Straight, L105mm	4,650
DM.04.1036 (2) , Curved, L105mm	4,720

Allis Tissue Forceps, with Sharp Teethed Jaws, L150 & 200mm, *Medicaluse* **NEW**

For Heavy Tissue, Stainless-steel 410, 엘리스 티슈 포셉/겸자, 의료용, 비부식



- Stainless-steel 410 : 비부식, 고강도, 고경도, 내약품성
- 수술 시 인체 조직/근막을 붙잡거나 다른 의료 기구를 단단히 고정할 때 사용
- 피부나 내장 장기에 사용하면 손상이 있을 수 있음
- Stainless-steel 410 : Rust-proof, High-Strength/Hardness, Chemical Resistance

* Used to Hold or Grasp Heavy Tissue

	Ea. Price, ₩
DM.04.1040 Tissue Forceps, Stainless-steel, Allis, 4 × 5 Tips, L150mm	19,670
DM.04.1041 , 5 × 6 Tips, L150mm	19,670
DM.04.1042 , L200mm	22,030

Bobcock Intestinal/Tissue Forceps, with Smooth- & Wide 11mm-Jaws, L180, *Medicaluse* NEW

For Delicate Tissue, Stainless-steel 410, **뱀코크 맹장/티슈 포셉/겸자, 의료용, 비부식**

NEW *Medicaluse*



- **Stainless-steel 410** : 비부식, 고강도, 고경도, 내약품성
- 수술 시 인체 내장 장기를 잡을 때 사용
- **Stainless-steel 410** : **Rust-proof, High-Strength/Hardness, Chemical Resistance**
- * For Grasping Delicate Tissue
- * Commonly Used in Laparotomy and Intestinal Processes

<M1>

Ea.	Price, ₩
-----	----------

DM.04.1045	Intestinal/Tissue Forceps, SS, Bobcock, Jaws-w11×72mm, L180mm	17,310
------------	---	--------

Asch & Walsham Septum Straightening Forceps, with Long Grip Handle, L235mm, *Medicaluse* NEW

For Rhinology Surgery, Stainless-steel 410, **애쉬 & 월샴 셉텀 포셉/겸자, 의료용, 비부식**

NEW

Medicaluse

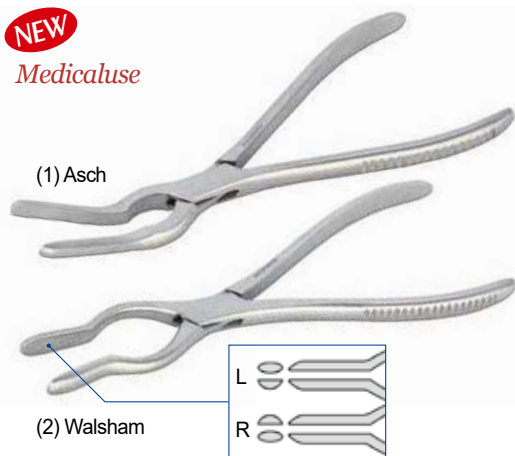

- **Stainless-steel 410** : 비부식, 고강도, 고경도, 내약품성
- 이비인후과에서 사용하며 코뼈 혹은 비중격 골절을 바로잡는 데에 사용
- **Stainless-steel 410** : **Rust-proof, High-Strength/Hardness, Chemical Resistance**

(1) Asch Forceps, with Angled Jaws, L235mm

<M1>

* Used to Elevate and Straighten the Septum

Ea.	Price, ₩
-----	----------

DM.04.1050	Septum Forceps, Stainless-steel, Asch, L235mm	43,260
------------	---	--------

(2) Walsham Forceps, with 1-Side Concave Jaw, L235mm

- * Used to Refracture and Realign the Nasal Bones
- * One Nasal Jaw is placed Externally while the Other Jaw goes into the Nose and Support the Nasal Bone
- * Available for the Left & Right Nasal Wall

Ea.	Price, ₩
-----	----------

DM.04.1051	Septum Forceps, Stainless-steel, Walsham, Left, L235mm	35,400
DM.04.1052	, Right, L235mm	35,400

Backhaus Towel Forceps, with Sharp Jaws, L90~130mm, *Medicaluse* NEW

For Holding Drape · Towel, Curved-type, Stainless-steel 410, **백 하우스 타월 포셉, 의료용, 비부식**

NEW

Medicaluse



- **Stainless-steel 410** : 비부식, 고강도, 고경도, 내약품성
- 타월 또는 수술포를 피부에 고정하거나 집을 때 사용
- **Stainless-steel 410** : **Rust-proof, High-Strength/Hardness, Chemical Resistance**

* Use to Statically Hold Surgical Drapes to the Patient's Skin, in order to define the Margins of the Operating Site <M1>

Ea.	Price, ₩
-----	----------

DM.04.1059	Towel Forceps, Stainless-steel, Curved, L90mm	8,180
DM.04.1060	, L105mm	8,340
DM.04.1061	, L130mm	8,500

NEW



Forceps & Pliers Stand, Stainless-steel, Rust-free, L200×h175mm, 포셉 · 플라이어 스탠드 NEW

- **Made in Korea**
- **Rustproof Stainless-steel; Rust-proof, Excellent Resistance of Acid / Chemicals / Heat**
- * Light Weight and Easy to Store

<L1>

Ea.	Price, ₩
-----	----------

SL.Sta7061	Stand for Forceps & Pliers, Stainless-steel, 200×h175mm	11,620
------------	---	--------

Articles	Cat. No	Description
----------	---------	-------------

DAIHAN® 1,100°C 0.4Lit Dental Compact Porcelain Furnace, with Ceramic Fiber Dish, Cylindrical $\phi 90 \times h65$ mm NEW
 For Pigmentation on the Outside of the Prosthesis, Short Heat-up Time, High Quality Insulation : Ceramic Fiber Board, 치과용 전기로



- Made in Korea ■ PL(Product Liability) Insurance
- with Certificate & Traceability : Controlled by Serial Number, Certificate, Delivery-information, and Traceable Data Base System
- 세라믹, 지르코니아 등 보철물 외면에 착색, 색상 발현 용도에 적합
- * 도어 고정 핸들을 통해 도어 간격 별 고정 가능
- * Light Weight and Easy to move

※ 운임 착불 <L1>

Spec.	Model	"Fur040.P"
Temp Range		400°C ~ 1,100°C
Capacity (Chamber)		0.4 Lit, Cylindrical $\phi 90 \times h65$ mm
Heater / Power		Kanthal A1, Inside Spiral Quartz Tube / 1.1kW
Thermocouple		K-Type Thermocouple
Timer		99hr 59min
Display		Digital LCD Display
Controller		Digital PID Programmable Controller
Program Function		5 Patterns with 9 Segments
Material / Insulation		External - Powder Coated Steel / Internal - Ceramic Fiber Insulation
Dimension (w×d×h)	Internal (cm)	$\phi 90 \times h65$
	External (cm)	w270×d290×h340
Gross Weight		16kg
Electrical Reqts.		1Phase, AC120V, 60Hz or AC 230V, 50/60Hz
Cat. No.	230V	DH.FurP040
	120V	DH.FurP041
Price, Each. ₩		1,611,000

DAIHAN® 1,650°C 0.7 & 1.8Lit Dental Sintering Furnace, with Ceramic Fiber Dish. Exposed Heating Elements-type, 2-Side Heating NEW
 For Firmly Fixing the Prosthesis, Short Heat-up Time, High Quality Insulation : Ceramic Fiber Board, 치과용 소결로/전기로



- Made in Korea ■ PL(Product Liability) Insurance
- with Certificate & Traceability : Controlled by Serial Number, Certificate, Delivery-information, and Traceable Data Base System
- 세라믹, 지르코니아 등 보철물을 가열하여 단단히 고정하는데 적합
- * 도어 고정 핸들을 통해 도어 간격 별 고정 가능
- * Light Weight and Easy to move

※ 운임 착불 <L1>

Spec.	Model	"Fur070.S"	"Fur180.S"
Temp Range		500°C ~ 1,650°C	
Capacity		0.7 Lit	1.8 Lit
Heater / Power		MoSi ₂ Heater, 2-Side Heating / 600W	MoSi ₂ Heater, 2-Side Heating / 1.4kW
Thermocouple		B-Type Thermocouple	
Timer		99hr 59min	
Display		Digital LCD Display	
Controller		Digital PID Programmable Controller, EPC3004	
Program Function		20 Patterns with 8 Segments	
Material / Insulation		External - Powder Coated Steel / Internal - Ceramic Fiber Insulation	
Dimension (w×d×h)	Internal (cm)	90×95×90	120×130×120
	External (cm)	320×380×490	350×420×560
Gross Weight		31kg	41kg
Electrical Reqts.		1Phase, AC120V, 60Hz or AC 230V, 50/60Hz	
Cat. No.	230V	DH.FurS070	DH.FurS180
	120V	DH.FurS071	DH.FurS181
Price, Each. ₩		7,297,000	10,087,000

Spare ; DH.FurS5003 (1) Ceramic Fiber Dish, 80×83×h16mm, for "Fur.S" ₩ 66,000 / Ea
 ; DH.FurS5004 , 80×83×h32mm, for "Fur.S" ₩ 66,000 / Ea
 ; DH.FurS5005 (2) Ceramic Fiber Stand, 90×25×h10mm, for Dish, 2ea/set ₩ 10,750 / Set

※ NOTE! Optional Heat Resistant Gloves
 ⇒ See the Next Page!

Ergonomic Desk Chair, with Mesh Back and Soft Cushion, Adjustable Height, Swivel, Stable, 600 × 480 × h1030~1110mm **NEW**
 Ideal for Office, Laboratory, Home &c., with or without Armrest, with Caster, 사무용 의자/결상



- Made in Korea
- 인체공학적 설계로 자세를 바르게 잡아줌으로써 피로감이 적음
- 메쉬 소재로 된 등받이를 사용하여 내구성을 높이고 통기성을 향상시킴
- 고급 패브릭원단으로 제작되어 편안하고 폭신한 쿠션으로 착석감이 좋음
- * Adjustment Height Up to 1110mm
- * Light Weight
- * Easy to Move
- * Mesh Back Cushion
- * Soft Cushion

		<L3>	
		Ea.	Price, ₩
A. With Armrest			
DH.Cha3001	(1) Desk Chair, w/ Armrest, 600 × 480 × h1030~1110mm, Black	105,000	
DH.Cha3002	(2) Desk Chair, w/ Armrest, 600 × 480 × h1030~1110mm, Blue	105,000	
B. Without Armrest			
DH.Cha3005	(3) Desk Chair, w/o Armrest, 600 × 480 × h1030~1110mm, Black	100,000	
DH.Cha3006	(4) Desk Chair, w/o Armrest, 600 × 480 × h1030~1110mm, Blue	100,000	

Folding Office Chair, with Mesh Back · Soft Cushion · Armrest · Caster, Stable, 585 × 610 × h650/860mm **NEW**
 Ideal for Office, Laboratory, Home &c., Waterproof, 사무용 의자/결상



- Made in Korea
- 메쉬 소재로 된 등받이를 사용하여 내구성을 높이고 통기성을 향상시킴
- 두꺼운 스펀지에 방수기능이 있는 고급 패브릭원단으로 제작하여 착석감이 좋음
- 좌판이 위로 올라가서 접혀 수평적재가 가능
- * 높이(좌석, 팔걸이, 전체) : 450, 650, 860mm
- * Mesh Back Cushion
- * Folding Seat
- * Light Weight
- * Easy to Move
- * Soft Cushion
- * Waterproof



		<L3>	
		Ea.	Price, ₩
DH.Cha3011	(1) Office Chair, w/ Armrest, 585 × 610 × h650/860mm, Black	73,000	
DH.Cha3012	(2) Office Chair, w/ Armrest, 585 × 610 × h650/860mm, Gray	73,000	

Articles	Cat. No	Description
----------	---------	-------------

NEW



(1) Single-Stage Regulator

Tanaka® Premium Regulator, with 1-Stage or 2-Stage, Precision type **NEW**
 Working Pressure(Inlet : 250kg/cm², Outlet : 10kg/cm²), 1~8Lit 고급형 레귤레이터

- Made in Japan
 - Nickel Plated C3604-Brass Body, Excellent Hot and Cold workability
 - Include Inlet SS Filter for Removing Impurities
 - SS316L Diagram Provides High Hardness and Corrosion Resistance
 - Display International System of Units : Mpa
 - Inlet Port : W22-14RH (Oxygen : W23-14RH, Hydrogen : W22.5-14RH)
 - Outlet Port : 1/4" Air Coupler
- * Ideal for High Purity Gas
 ※ Please Let us Know the Pipe Size when Your Custom Order !

(1) Single-Stage, Heavy-Duty Regulator

- DH.Reg8006 Regulators, Single-stage, 1Mpa, Air, Argon, Nitrogen, Helium
 DH.Reg8007 , Oxygen
 DH.Reg8008 , Hydrogen
 DH.Reg8009 , 0.6Mpa, CO₂

<L5>	
Ea.	Price, ₩
	171,160
	171,160
	171,160
	171,160



(2) Two-stage Regulators

(2) Two-stage Regulators, CM2-series, Precision type

- * First-stage : Reduces Cylinder Pressure to Nearly 90% and Removes Impurities
- * Second-stage : Accurately Control the Discharge Pressure
- * The Output Pressure is Fixed Even if the Input Pressure is Changed

- DH.Reg8011 Regulators, Two-stage, 1Mpa, Air, Argon, Nitrogen, Helium
 DH.Reg8012 , Oxygen
 DH.Reg8013 , Hydrogen
 DH.Reg8014 , 0.6Mpa, CO₂

Ea.	Price, ₩
	297,660
	297,660
	297,660
	297,660



(3) Needle Valve for Regulator

(3) Optional Needle Valve

- * Inlet & Outlet : 1/4" NPT

- DH.Reg8101 Needle Valve for Regulators

Ea.	Price, ₩
	22,330

Wellz 가스 조절기, Gas Regulator of O₂/LPG/AC 다국적

생산물배상책임보험 3억원 보험가입

NEW



(1) 산소조정기(OX)



(2) 프로판조정기(LPG) 가스안전공사 인증제품



(3) 아세틸렌조정기(AC)

ORDER NO.	MODEL NO.	품명	PRICE, ₩ Ea.	1차 압력		포장단위 Ea. / PK.
				kgf/cm ²		
(1) 0284-077	SWR - 101	산소조정기(OX)	20,030	250	25	1 / 24
(2) 0284-078	SWR - 102	프로판조정기(LPG)	16,390	-	3	
(3) 0284-079	SWR - 103	아세틸렌조정기(AC)	20,940	25	3	

Wellz 가스 조절기, Gas Reguator of AR/N₂/CO₂ 다국적

NEW



(1) 알곤조절기(AR)



(2) 질소조절기(N₂)



(3) 이산화탄소조절기(CO₂)

<B3>

ORDER NO.	MODEL NO.	품명	PRICE, ₩ Ea.	1차 압력	2차 압력	포장단위 Ea. / Pk.
				kgf/cm ²		
(1) 0284-080	SWR-104	알곤조절기(AR)	21,840	250	-	1 / 18
(2) 0299-164	SWR-105	질소조절기(N ₂)	29,120	250	10	1 / 18
(3) 0348-187	SWR-106A(110V / 22mm)	이산화탄소조절기(CO ₂)	46,420	-	6	1 / 12
0348-190	SWR-106B(220V / 22mm)					
0385-099	SWR-107A(110V / 23mm)					
0385-101	SWR-107B(220V / 23mm)					

Wellz 가스 역화 방지기, Gas Flashback Arrestor 다국적

NEW

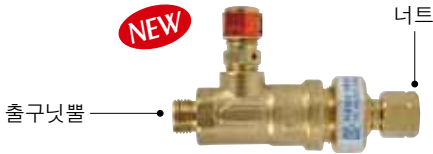

생산물배상책임보험 3억원 보험가입

<B3>

ORDER NO.	MODEL NO.	PRICE, ₩ Ea.	타입	포장단위 Ea. / Pk.
0284-207	DS-100	13,660	LPG, AC	1 / 50

가스 조절기 부품(CO₂, OX), Parts for Gas Regulator

KOREA



ISO 9001

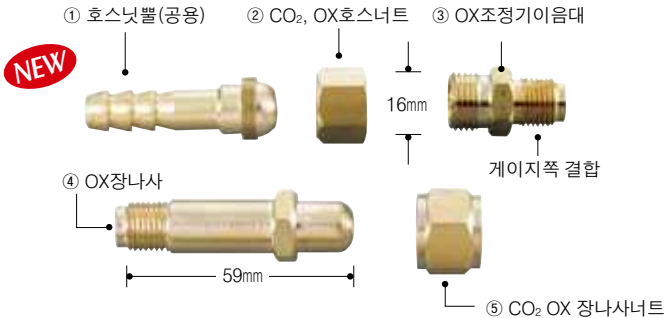

<B3>

ORDER NO.	품명	PRICE, ₩ Ea.	규격	포장단위 Ea. / Pk.
① 0472-854	호스닛뿔(공용)	-	-	-
② 0472-853	CO ₂ , OX호스너트	1,480	M16×1.5	1 / 5
③ 0307-820	OX조절기이음대	-	-	-

ORDER NO.	품명	PRICE, ₩ Ea.	규격	포장단위 Ea. / Pk.
④ 0307-828	OX장나사	2,950	59mm	1 / 5
⑤ 0307-825	CO ₂ , OX 장나사너트	3,130	23mm	1 / 5

, Torches 토치



Kovea® Gas Torch, Piezo-electric Auto-ignition, 135g With Adjustable Flame, One-Touch Coupling, 가스 토치, 압전 자동점화

* 숲, 파이프 작업 등 다용도로 사용가능 * Size : 150×43×h200mm * Weight : 135g
 * Manual Ignition * Fuel : Butane * Gas Consumption : 80g / hr

<B3>

K12.KT2211 Torch, Safety, 150×43×h200mm, 135g

Ea.	Price, ₩
	11,680

Articles	Cat. No	Description
----------	---------	-------------

NEW



Buffalo® Long Gas Torch, Brass, Excellent Hardness & Strength, 210mm × 70mm

Various Uses, Max Temp 1800°C, 롱 가스토치, 다용도, 부탄가스사용

- 야외활동이나 작업용 용접 등 다양한 활용
- Butane Gas(220g캔) 사용
- * Long Brass Brazier
- * Brass with Excellent Hardness and Strength
- * Various Application : Camping, Welding Etc.
- * Max Temp : 1800°C

BFL.801 Long Gas Torch, 210mm × 70mm, Color : Blue

<B3>	
Ea.	Price, ₩
	4,540

Wellz 가스절단기 토치, Cutting Torch

생산물배상책임보험 3억원 보험가입

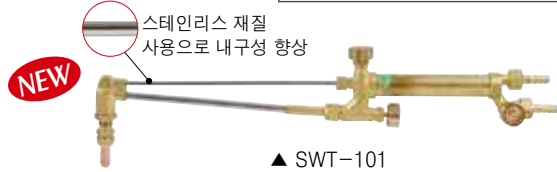

NEW

스테인리스 재질
사용으로 내구성 향상

▲ SWT-101 <B3>

ORDER NO.	MODEL NO.	PRICE, ₩ Ea.	규격	전장(mm)	포장단위 Ea. / Pk.
▶ 0284-075	SWT-101	19,480	중형	450	1 / 35
0299-089	SWT-201	27,390	대형	550	1 / 25
0307-296	SWT-301	28,120	장대형	630	1 / 20

Wellz 가스용접기 토치, Welding Torch

NEW



▲ SWT-102 <B3>

ORDER NO.	MODEL NO.	PRICE, ₩ Ea.	규격	전장(mm)	포장단위 Ea. / Pk.
▶ 0284-076	SWT-102	16,940	소형	400	1 / 20
0299-088	SWT-202	19,020	중형	450	1 / 20

가스용접기 토치, Gas Welding Torch KOREA



(1) Mini형 **NEW**

▲ DK-100 <B3>

ORDER NO.	MODEL NO.	PRICE, ₩ Ea.	전장(mm)	포장단위 Ea. / Pk.
0307-713	DK-100	40,090	300	1 / 70

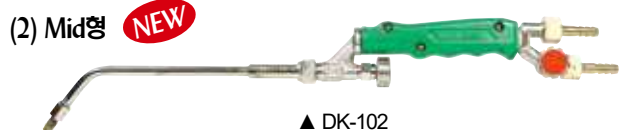

(2) Mid형 **NEW**

▲ DK-102 <B3>

ORDER NO.	MODEL NO.	PRICE, ₩ Ea.	전장(mm)	포장단위 Ea. / Pk.
0307-715	DK-102	38,620	430	1 / 40
0455-405	DK-102	42,340	480	1 / 40

Wellz 절단화구(LPG/AC), Cutting Torch Tip

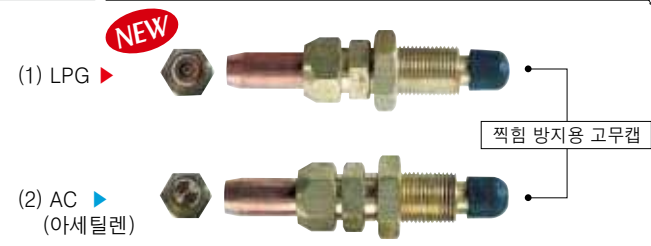

- (1) LPG
- (2) AC (아세틸렌)

찍힘 방지용 고무캡

생산물배상책임보험 3억원 보험가입

- 화구 번호가 클수록 화구 고압 분출 홀은 커짐
- 고무 캡 제거 후 사용

ORDER NO.	타입	PRICE, ₩ Ea.	규격	포장단위 Ea. / Pk.
▶ 0299-092			대형 #1	
0299-091	(1) LPG	3,400	대형 #2	1 / 10
0299-090			대형 #3	
▶ 0284-084	(2) AC	2,560	중형 #2	1 / 10

가스용접기 자동절단화구(LPG용) 다국적

Auto Gas Cutting Torch Tip (K, CCC, E, ISO 9001)



NEW

▶ LPG용

- 자동가스절단기, 중앙절단기 전용으로 사용하는 절단화구
- 절단할 모재의 두께 (+)에 따라 번호선택

ORDER NO.	MODEL NO.	PRICE, ₩ Ea.	규격	포장단위 Ea. / Pk.
0307-835			#0	
0307-836			#1	
0307-837	DK-601T	12,830	#2	1 / 10
0307-839			#3	
0307-841			#4	
0307-840		12,830	#5	
0307-838	DK-601T	12,830	#6	1 / 10
0307-787		14,220	#7	
0307-788		14,220	#8	

Wellz CO₂ 토치, CO₂ Gas Torch

KOREA

NEW



- 일반형 CO₂ 토치
- 손잡이 부분 인체 공학적 설계로 피로도 감소

<B3>

ORDER NO.	규격	PRICE, ₩ Ea.	길이 (M)	용량 (SQ)	포장단위 Ea. / Pk.
0438-869	350A	86,240	5	30	1 / 5
0438-872	500A	107,800	5	50	1 / 5

HANTO 플라즈마 토치세트, Plasma Torch Set

KOREA

ISO 9001 / ISO 14001

NEW



① P-80 토치세트



② OTC-30A 토치세트



③ P-80 토치헤드



④ 플라즈마 스위치

- OTC-30A(M-3000)장비용 플라즈마 토치임
- 커넥터는 φ25-2P포함

<B3>

*15M이상 별도주문

ORDER NO.	품명	PRICE, ₩ Ea.	규격	포장단위 Ea. / Pk.
① 0250-989	P-80 토치세트	174,440	10M	1 / 1
② 0251-227	OTC-30A 토치세트	169,550	10M	1 / 1

ORDER NO.	품명	PRICE, ₩ Ea.	규격	포장단위 Ea. / Pk.
③ 0250-990	P-80 토치헤드	62,040	80A	1 / 1
④ 0299-093	플라즈마 스위치	2,270	고무	1 / 1

HANTO 알곤토치(350A) 공냉, Tig Torch Assembly-Air Cooling

KOREA

ISO 9001 / ISO 14001

<B3>

NEW

파워케이블



커넥터 φ25-2P

가스라인

ORDER NO.	규격	PRICE, ₩
0251-058	4M	83,310
0250-979	6M	97,030
0251-059	8M	111,720
0251-060	10M	124,470
0258-359	15M	162,200

Articles	Cat. No	Description
----------	---------	-------------

DURAN® Original 45° DN-Standard Flange with O-Ring Groove, for Vacuum / Pressure Reaction Flasks / Vessels, Boro-glass 3.3
 정품 DURAN® 표준 45° DN 플랜지 반제품, 반응조 하부 플라스크에 접합하는 플랜지임, 진공/압력용 O-링 홈부 **NEW**

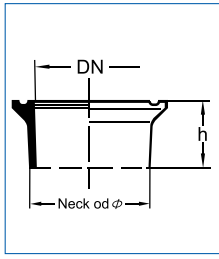

■ Supplied by DURAN® in Germany

* Joining in DURAN® Original 45° DN-Standard Flange with DURAN® Blanks (Cat.No.210200** or 21027***-series).

* Interchangeable for DN-Flanged Reaction Vessel

* With Groove for Vacuum O-ring

Standard Flange Specification / "DN" : Complies with DIN Specification

- DN60 : id60×od100mm • DN120 : id120×od158mm • DN200 : id200×od242mm
- DN100 : id100×od138mm • DN150 : id150×od184mm

- SM.2103434** DN 60 Flange : idφ60 ×odφ100, Neck od. 70×Thick. 5±1×h50 mm, 2.5 bar
- SM.2103446** DN 100 Flange : idφ100×odφ138, Neck od. 106×Thick. 5±1×h60 mm, 1.5 bar
- SM.2103451** DN 120 Flange : idφ120×odφ158, Neck od. 130×Thick. 6±1×h60 mm, 1.5 bar
- SM.2103457** DN 150 Flange : idφ150×odφ184, Neck od. 155×Thick. 6±1×h75 mm, 1bar
- SM.2103461** DN 200 Flange : idφ200×odφ242, Neck od. 215×Thick. 7.5±1×h75 mm, 1bar

<L6>			
Ea.	Price, ₩	Pk.	Price, ₩
	39,950	2ea	79,890
	54,960	2ea	109,910
	80,760	2ea	161,520
	106,270	2ea	212,520
	144,560	2ea	289,110



(1) φ65~φ250 Cylindrical-form Vessel Blank

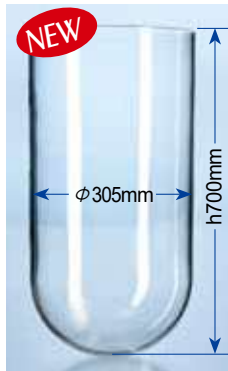

(2) φ305 Cylindrical-form Vessel Blank



(3) φ106~φ250 Kettle-form Vessel Blank

DURAN® Blanks, for Reaction Flask / Vessel, Boro-glass 3.3, φ65~φ305mm **NEW**
 φ65~φ305mm까지의 2중 반응조용 반제품, 반응조(하부) 플라스크 제조용

■ Supplied by DURAN® in Germany

* Typical Application; Manipulate DURAN® Blanks with Above "DN-Standard Flange"

(1) φ65~φ250mm Cylindrical-form Vessel Blank, 실린더(원통)형 베셀제조용

- SM.21027377** Vessel Blank, for-DN 60, 100~500ml ; φ 65 / Thick. 3.5×h400mm, 2.5 bar
- SM.2102054** -DN 100, 0.5~1 Lit ; φ106 / Thick. 4×h145mm, 2.5 bar
- SM.21027477** ×h400mm, 2.5 bar
- SM.21027537** -DN 120, 2 & 3 Lit ; φ130 / Thick. 4×h400mm, 2 bar
- SM.21027557** -DN 150, 5~7 Lit ; φ160 / Thick. 4.5×h400mm, 1.5 bar
- SM.21027627** -DN 200, 10~20 Lit ; φ215 / Thick. 5.5×h400mm, 1.0 bar
- SM.21927627** ×h500mm, 1.0 bar
- SM.21027667** ; φ250 / Thick. 5.5×h400mm, 1.0 bar
- SM.21927667** , 20 Lit ; φ250 / Thick. 5.5×h500mm, 1.0 bar

<L6>	
Ea.	Price, ₩
	28,390
	28,520
	40,550
	43,130
	79,560
	112,790
	132,160
	144,890
	159,500

(2) φ305 Cylindrical-form Vessel Blank, 실린더(원통)형 대용량 베셀제조용

- SM.2199351** Vessel Blank, for-DN 200, 20~30 Lit ; φ305 / Thick. 6.0×h700mm, 1.0 bar

Ea.	Price, ₩
	553,240

(3) φ106~φ250mm Kettle-form Vessel Blank, 케틀형 베셀제조용

- SM.2102063** Vessel Blank, for-DN 100, 2.6 Lit ; Neck φ106 / φ140×h210 ×Thick. 4mm, 1.5 bar
- SM.2102071** -DN 150, 4~5.8 Lit ; Neck φ155 / φ200×h215 ×Thick. 4.5mm, 1.0 bar
- SM.2102076** , 6~7.4 Lit ; Neck φ155 / φ215×h245 ×Thick. 4.5mm, 1.0 bar
- SM.21027587** , 5~6 Lit ; φ185×h400 ×Thick. 4.5mm, 1.5 bar
- SM.2102086** , 10 Lit ; Neck φ155 / φ240×h335 ×Thick. 5.5mm, 0.5 bar
- SM.21927667** -DN 200, 20 Lit ; φ250×h500 ×Thick. 5.5mm, 1.0 bar

Ea.	Price, ₩
	46,190
	102,950
	119,300
	95,720
	175,490
	159,500



DURAN® Blanks, Round Bottom Flaks, for Reaction Vessel, 50 Lit **NEW**
 with Wall Thick 4~5mm, Boro-glass 3.3, 반제품, 반응조용 환저 플라스크

■ Supplied by DURAN® in Germany

* Wall Thickness : 4~5mm

* Neck Wall Thickness : 4~10mm

* Neck Height : 153.7mm

- SM.2199215** Flask, Blank, 50 Lit. od 480×h 650mm, neck φ110mm

<L6>	
Ea.	Price, ₩
	1,433,360



(1) Low-form, Unground



(2) Thin & Tall-form, Ground

DURAN® Thick. 4mm Blanks, for Reaction Flask Lids, with Flange, Boro-glass 3.3 NEW
 4mm 두께의 반응조 뚜껑 반제품 ; 여기에 희망하는 “중조인트 & 수량”을 접합시킴

■ Supplied by DURAN® in Germany

* Standard Thinner Blanks for Easy manipulating. * Best Standard Production with Low Cost and Less Time

* Resistant Pressure : - DN60 Flange : 2.5 bar, DN100 Flange : 1.5 bar - DN120 Flange : 1.3 bar, DN150/200 Flange : 1.0 bar <L6>

(1) Low-form, Unground : 낮은형, Flange 연마 안된것

SM.2103734 Flask, Blank, Lid, DN 60, Flange id 60×od100, h42 mm

Ea.	Price, ₩	Pk.	Price, ₩
	38,710	6ea	232,240

(2) Thin & Tall-form, Ground : 얇고 높은형, Flange 완전 연마형

SM.2103846 Flask, Blank, Lid, Thick 4mm, DN100, Flange id100×od138, h65mm
 SM.2103851 , DN120, Flange id120×od158, h70mm
 SM.2103857 , DN150, Flange id150×od184, h70mm
 SM.2103861 , DN200, Flange id200×od242, h95mm

Ea.	Price, ₩	Pk.	Price, ₩
	74,520	3ea	223,530
	85,550	4ea	342,190
	96,600	2ea	193,180
	123,130	2ea	246,260



DURAN® Blank-Cylinder, Hexagonal-base, 100~500ml NEW
 Ideal for Gas Washing Bottles, Boro-glass 3.3, 반제품, 가스 세척병 제조용

■ Supplied by DURAN® in Germany

SM.2139224 Cylinder, Blank, 100ml, od 38×h164mm
 SM.2139236 , 250ml, od 53×h192mm
 SM.2139244 , 500ml, od 65×h250mm

Ea.	Price, ₩	Pk.	Price, ₩
	10,880	10ea	
	16,750	10ea	
	20,830	10ea	



(1) 100~2000ml Blanks

(2) 3 & 5Lit Blanks

DURAN® Blanks, for Standard Separatory Funnel, Boro-glass 3.3, 분액깔때기 반제품 NEW

(1) DURAN® 100~2,000ml Blanks, Separatory Funnel, Conical-type

■ Supplied by DURAN® in Germany

SM.2101324 Fun., sepa., Blank, 100ml, φ 64×h143, neck φ 32 mm
 SM.2101336 , 250ml, φ 85×h189, neck φ 38 mm
 SM.2101344 , 500ml, φ 105×h225, neck φ 44 mm
 SM.2101354 , 1000ml, φ 131×h278, neck φ 48 mm
 SM.2101363 , 2000ml, φ 166×h343, neck φ 50 mm

Ea.	Price, ₩	Pk.	Price, ₩
	5,870	10ea	58,630
	6,070	10ea	60,550
	7,930	10ea	79,180
	9,520	10ea	95,060
	43,950	2ea	87,890

(2) 3 & 5Lit Blank, Erlenmeyer Flask

■ Supplied by SciLab Korea

SLg.Fla1077 Flask, Blank, 3 Lit. od 187×h310mm, neck φ 50mm
 SLg.Fla1078 , 5 Lit. od 220×h365mm, neck φ 50mm

Ea.	Price, ₩
	22,980
	35,780



DURAN® Blanks, for Evaporating Flasks, Boro-glass 3.3, 100~3,000ml NEW
 반제품, 농축-플라스크 제조용

SM.2102824 Flask, Blank, Evap, 100ml, od 60×h105 mm, neck φ 35
 SM.2102836 , 250ml, od 81×h135 mm, neck φ 35
 SM.2102844 , 500ml, od101×h165 mm, neck φ 35
 SM.2102854 , 1000ml, od126×h205 mm, neck φ 35
 SM.2102863 , 2000ml, od158×h240 mm, neck φ 50
 SM.2102868 , 3000ml, od176×h284 mm, neck φ 52

Ea.	Price, ₩	Pk.	Price, ₩
	9,470	10ea	94,520
	11,400	10ea	113,960
	14,370	10ea	143,550
	21,740	10ea	217,240
	53,920	10ea	539,080
		1ea	87,800

Articles	Cat. No	Description
----------	---------	-------------

DAIHAN® 10mm PMMA Glove Box Complete Set, with Natural Rubber Glove and Transfer Chamber NEW
 With Internal Outlet, Foot S/W for Internal Pressure Regulation, Vacuum Pressure 1 Torr, for 1 Operator, 표준형 글러브박스, 1인용



A & B. 150Lit & 179Lit



(1) Natural Rubber Gloves(Included)

- **Made in Korea** ■ **Compact, Portable, Lightweight and Self-contained**
- **Ergonomic Design to Fit the Average Person**
- **For Isolating Sensitive Research Studies from a Hostile Exterior Environment**
- **The Front Slopes Viewing Panel Minimizes Glare**
- * Light Weight and Easy to move from Lab to Lab
- * Excellent Viewing & Air Tight Structure
- * Vacuum Gauge on Transfer Chamber
- * Main Chamber Foot Switch for Control Internal Pressure, Humidity and Oxygen

Specifications & Ordering information <L2>

Spec.		Model	A. GloB.600P 150 Lit	B. GloB.800P 179 Lit
Main Chamber (w×d×h)	Outer D.		760×450×550mm	800×500×550mm
	Inner D.		740×430×530mm	780×480×530mm
	Thickness		10mm	
Transfer Chamber (w×d×h)	Outer D.		290×180×180mm	
	Inner D.		250×140×140mm	
	Thickness		20mm	
Material			PMMA(Polymethyl Methacrylate Resin)	
Vacuum Gauge			-1 to 1 Bar	
Vacuum Pressure			Main Chamber : 1Torr, Pass Box : 1Torr	
Vacuum Outlet			O.D. ϕ9mm	
Gas Inlet			One touch Fitting, 1Ea.(I.D. ϕ6mm)	
Electric Outlet			2×220V and 2×110V	
Gloves			Natural Rubber Gloves, L640mm, 0.4mm thick	
Glove Port			2 Ports, 8"(ϕ203mm)	
Weight			32 kg	35 kg
Cat. No.			DH.GloB600P	DH.GloB800P
Price, Each. ₩			3,808,000	4,335,000

Spare Gloves

Cat. No.	Description	Pair Price, ₩
SL.Glo6623	(1) Natural Rubber Glove, 8"(ϕ200mm), L780mm, 0.6mm thick	102,040

※ Detailed Parts of Glove Box

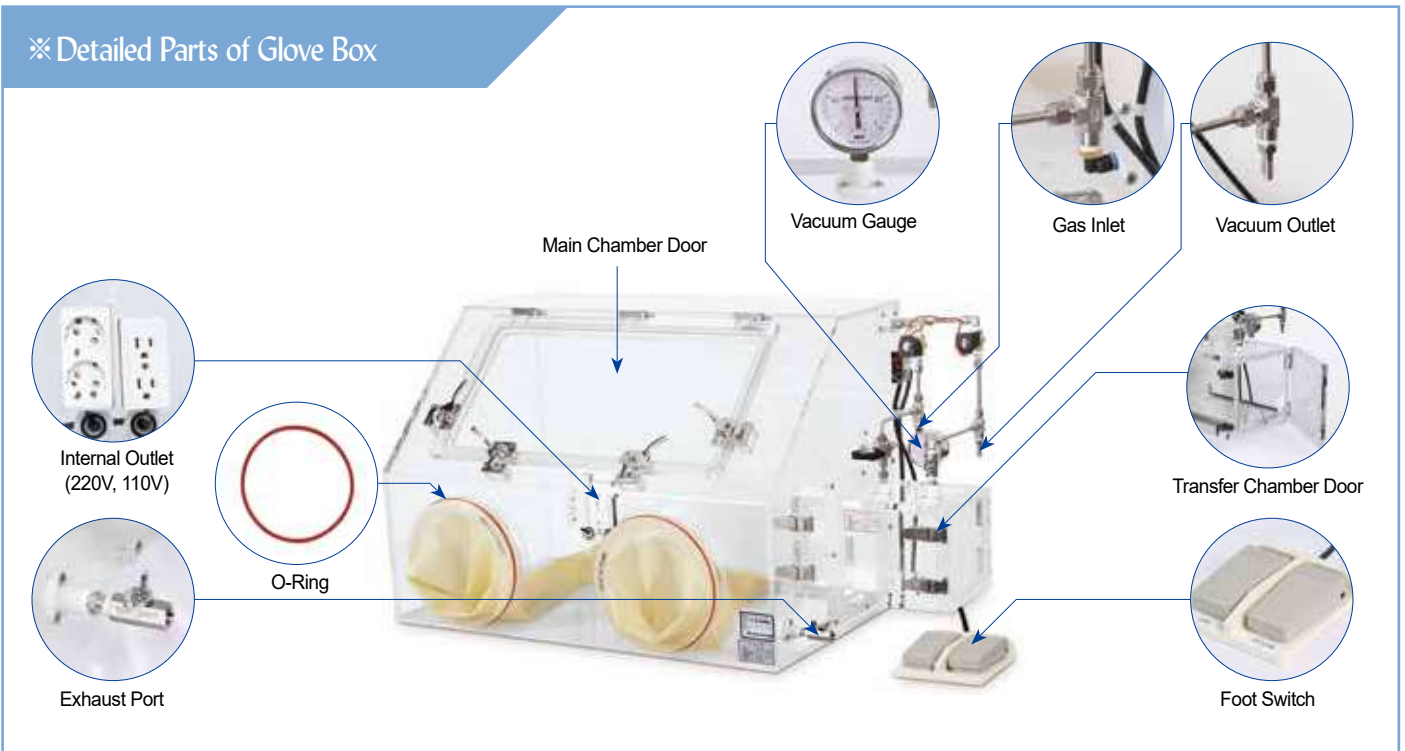

DAIHAN® Premium 15mm PMMA Heavy Duty Glove Box Complete Set, with Natural Rubber Glove and Transfer Chamber NEW
 With Internal Outlet, Foot S/W for Internal Pressure Regulation, Vacuum Pressure 1 Torr, for 1 & 2 Operators, **프리미엄 안전 글러브박스, 1 & 2인용**



A. 182L, for 1 Operator



B. 416L, for 2 Operators



(1) Natural Rubber Gloves(Included)

※ Detailed parts of Glove Box
 ⇒ See the Previous Page.

- Made in Korea
- Compact, Portable, Lightweight and Self-contained
- Ergonomic Design to Fit the Average Person
- For Isolating Sensitive Research Studies from a Hostile Exterior Environment
- The Front Slopes Viewing Panel Minimizes Glare
- * Light Weight and Easy to move from Lab to Lab
- * Excellent Viewing & Air Tight Structure
- * Vacuum Gauge on Transfer Chamber
- * Main Chamber Foot Switch for Control Internal Pressure, Humidity and Oxygen

Specifications & Ordering information <L2>

Spec.	Model	1 Operator type	2 Operators type
		A. GloB.G01 182 Lit	B. GloB.G01.2 416 Lit
Main Chamber (w×d×h)	Outer D.	800×500×550mm	1530×530×630mm
	Inner D.	770×470×530mm	1500×500×600mm
	Thickness	15mm	
Transfer Chamber (w×d×h)	Outer D.	390×250×250mm	
	Inner D.	350×210×185mm	
	Thickness	20mm	
Material	PMMA(Polymethyl Methacrylate Resin)		
Vacuum Gauge	-1 to 1 Bar		
Vacuum Pressure	Main Chamber : 1Torr, Pass Box : 1Torr		
Vacuum Outlet	O.D. ϕ9mm		
Gas Inlet	One touch Fitting, 1Ea.(I.D. ϕ6mm)		
Electric Outlet	2×220V and 2×110V		
Gloves	Natural Rubber Gloves, L640mm, 0.4mm thick		
Glove Port	2 Ports, 8"(ϕ203mm)	4 Ports, 8"(ϕ203mm)	
Weight	51 kg	86 kg	
Cat. No.	DH.GloBG01	DH.GloBG012	
Price, Each. ₩	5,650,000	13,019,000	

Spare Gloves

Cat. No.	Description	Pair Price, ₩
SL.Glo6623	(1) Natural Rubber Glove, 8"(ϕ200mm), L780mm, 0.6mm thick	102,040



(1)



(2)



(3)

Glove For Glove Box, 3 Different Materials - Neoprene · Butyl · Hypalonized Polyethylene NEW
 ϕ203×L800mm, Thickness 0.4~0.8mm, **글러브박스용 글러브**

- Neoprene 글러브는 방진·방균용으로서 무균 박스나 드라이 박스에서의 사용에 적합
- Butyl/Hypalon 글러브는 반발력이 매우 작고, 부드럽고 유연, 가스불투과성·액체불투과성이 뛰어나

Cat. No.	Description	Pair Price, ₩
SL.Glo6632	Neoprene Glove, Thickness 0.8mm, Black * Dustproof, Anti Fungus, Suitable for Sterile Box or Dry Box * Milled Neoprene Gloves for Increased Sensitivity	508,460
SL.Glo6633	Butyl Glove, Thickness 0.6mm, Black * Made of 2 Layer Materials - Chloroprene/Butyl * The Highest Permeation Resistance to Vapors and Gases. * Exceptional Resistance to a Broad Range of Toxic Chemicals	864,380
SL.Glo6634	Hypalonized Polyethylene Glove, Thickness 0.4mm, White * Resist Ozone and Oxidizing Chemicals * Superior Chemical and U.V. Resistance.	694,900

Natural Rubber Gloves for Glove Box, for Port ϕ130~200mm, Length 630~780mm
 Powdered, Thickness 0.4 & 0.6mm, **천연 고무 글러브박스용 장갑**

Cat. No.	Description	Pair Price, ₩
SL.Glo6621	Gloves For Glove Box, Thickness 0.4mm, ϕ130×L630mm	79,330
SL.Glo6622	, Thickness 0.6mm, ϕ150×L700mm New	56,800
SL.Glo6623	, ϕ200×L780mm New	102,040

DAIHAN® Premium 40mm PMMA Vacuum Glove Box Complete Set, with Natural Rubber Glove and Transfer Chamber NEW
 With Internal Outlet, Foot S/W for Internal Pressure Regulation, Vacuum Pressure 10 Torr, for 1 Operator, **프리미엄 진공 클러브박스, 1인용**



212L Vacuum Glove Box Complete Set



(1) Natural Rubber Gloves(Included)

- **Made in Korea** ■ **Ergonomic Design to Fit the Average Person**
- **Compact, Portable, Lightweight and Self-contained**
- **For Isolating Sensitive Research Studies from a Hostile Exterior Environment**
- **The Front Slopes Viewing Panel Minimizes Glare**
- * Light Weight and Easy to move from Lab to Lab * Excellent Viewing & Air Tight Structure
- * Vacuum Gauge on Main Chamber and Transfer Chamber
- * Foot S/W for Internal Pressure Regulation
- * The Main Chamber Foot Switch can be Used to Effectively Control Internal Humidity and Oxygen

Specifications & Ordering information <L2>

Spec.		Model	GloB.INVGA01 212 Lit
Main Chamber (w×d×h)	Outer D.		1,000×580×700mm
	Inner D.		840×500×550mm
	Thickness		40mm
Transfer Chamber (w×d×h)	Outer D.		390×250×250mm
	Inner D.		350×210×185mm
	Thickness		20mm
Material			PMMA(Polymethyl Methacrylate Resin)
Vacuum Gauge			-1 to 1 Bar
Vacuum Pressure			Main Chamber : 10Torr, Pass Box : 1Torr
Vacuum Outlet			O.D. ϕ9mm
Gas Inlet			One touch Fitting, 1Ea.(I.D. ϕ6mm)
Electric Outlet			2×220V and 2×110V
Gloves			Natural Rubber Gloves, L640mm, 0.4mm thick
Glove Port			2Ports, 8"(ϕ203mm)
Weight			137 kg
Cat. No.			DH.GloBINVGA01
Price, Each. ₩			10,738,000

Spare Gloves

SL.Glo6623 (1) High Grade Natural Rubber Glove, 8"(ϕ200mm), L780mm , 0.6mm thick

Pair	Price, ₩
	102,040

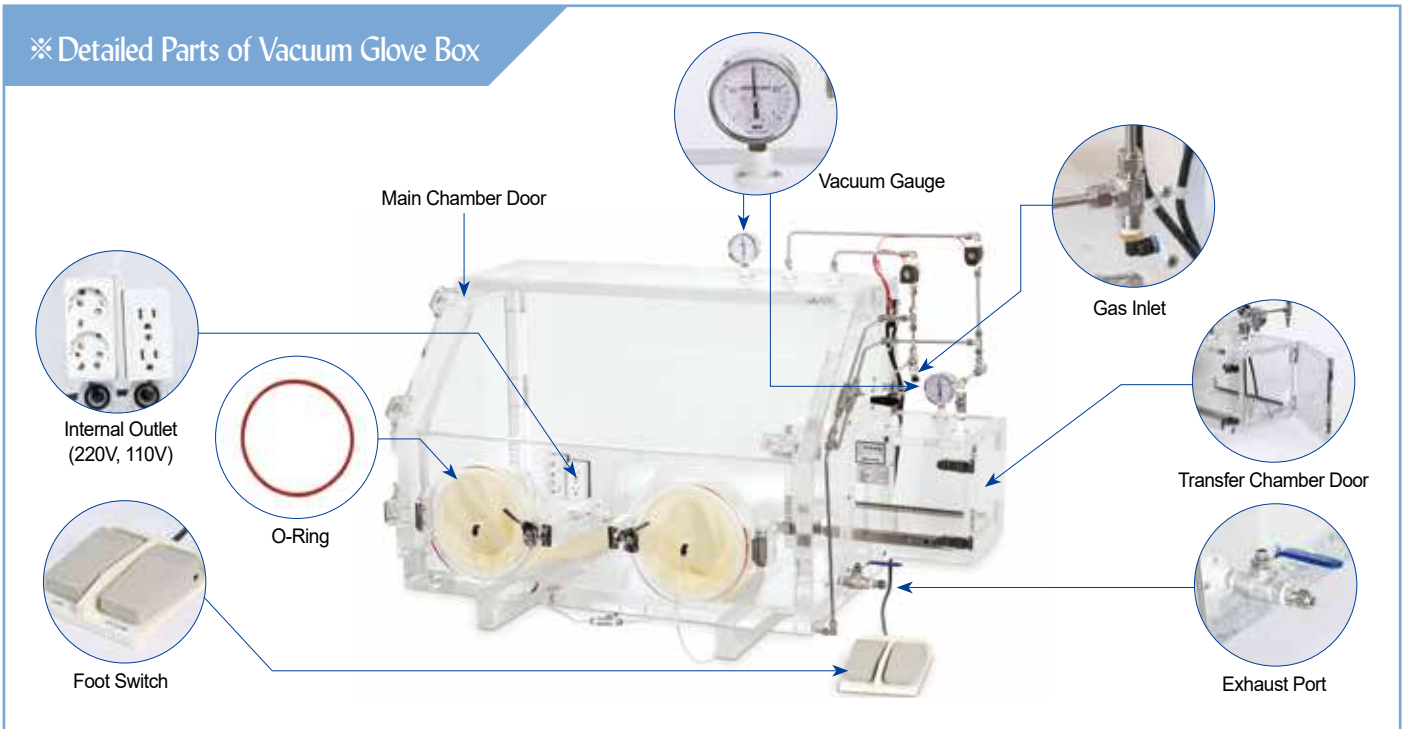



Sterile Latex Surgical Glove

Sterile Latex Surgical Glove, Comfort Fit, Powder-Free, L280mm, *Medicaluse* NEW
 With Micro Rough Surface, Disposable, 6.5"~7.5", 수술용 멸균 라텍스 장갑

- Supplied by TOP GLOVE® in Malaysia ■ Meet All Requirements under ASTM D 3577 and EN 455 Standards
- ISO 9001 and ISO 13485 * Made of High Quality Latex * Gamma Sterilized
- * Sterile Individual Packaging * Thickness (mm) : Min. 0.16 (Cuff) ; 0.18 (Palm) ; 0.23 (Fingers)

DM.13.1042 Surgical Glove, Latex, Sterile, Powder Free, 6.5"
 DM.13.1043 , 7"
 DM.13.1044 , 7.5"

	Pk.	Price, ₩
<M3>	50pair	37,760
	50pair	37,760
	50pair	37,760



Medicaluse
 Blue White

WisdGlove™ Premium Nitrile Clean Glove, for Medical & Exam, L240mm, *Medicaluse*
 With Textured, Powder Free, Ambidextrous, Premium Grade AQL 1.5, 니트릴 장갑, 실험·의료용 NEW

- 식약처 인증 의료용 장갑 ■ CE Certified ■ Blue & White Color
- Meet All Requirements under EN 455 Standard.
- * Excellent Durability and Chemical Resistance, Non-sterile
- * Width Size(mm) : 87±5(X-S); 88±5(S); 108±5(M); 117±5(L)
- * Thickness(mm) : 0.12±0.02(cuff); 0.16±0.02(Palm); 0.22±0.02(Finger Tip)
- * Elongation : Min. 500% * Tensile Strength : Min. 14.0(MPa)



<M1>

Size	(1) Blue			(2) White		
	Cat. No.	Pk. Price, ₩	Cs. Price, ₩	Cat. No.	Pk. Price, ₩	Cs. Price, ₩
X-Small	DH.Glo6051	100ea 21,240	10pk 196,640	DH.Glo6061	100ea 21,240	10pk 196,640
Small	DH.Glo6052	100ea 21,240	10pk 196,640	DH.Glo6062	100ea 21,240	10pk 196,640
Medium	DH.Glo6053	100ea 21,240	10pk 196,640	DH.Glo6063	100ea 21,240	10pk 196,640
Large	DH.Glo6054	100ea 21,240	10pk 196,640	DH.Glo6064	100ea 21,240	10pk 196,640

, Clean Room 크린룸용 장갑



Blue White

WisdGlove™ Premium Foodstuff Clean Glove, Nitrile, for Exam & Foodstuff, L240mm NEW
 Textured, Powder Free, Ambidextrous, Premium Grade AQL 1.5, 니트릴 크린 장갑, 식품·실험용

- 식약처 인증 식품용 장갑 ■ CE Certified ■ Blue & White Color
- Meet All Requirements under EN 455 Standard.
- * Excellent Durability and Chemical Resistance, Non-sterile
- * Width Size(mm) : 87±5(X-S); 88±5(S); 108±5(M); 117±5(L)
- * Thickness(mm) : 0.12±0.02(cuff); 0.16±0.02(Palm); 0.22±0.02(Finger Tip)
- * Elongation : Min. 500% * Tensile Strength : Min. 14.0(MPa)



<L1>

Size	(1) Blue			(2) White		
	Cat. No.	Pk. Price, ₩	Cs. Price, ₩	Cat. No.	Pk. Price, ₩	Cs. Price, ₩
X-Small	DH.Glo6011	100ea 21,240	10pk 196,640	DH.Glo6021	100ea 21,240	10pk 196,640
Small	DH.Glo6012	100ea 21,240	10pk 196,640	DH.Glo6022	100ea 21,240	10pk 196,640
Medium	DH.Glo6013	100ea 21,240	10pk 196,640	DH.Glo6023	100ea 21,240	10pk 196,640
Large	DH.Glo6014	100ea 21,240	10pk 196,640	DH.Glo6024	100ea 21,240	10pk 196,640



Clear Blue

WisdGlove™ Premium Foodstuff Clean Glove, PVC, for Exam & Foodstuff, L240mm NEW
 Textured, Powder Free, Ambidextrous, Premium Grade AQL 1.5, PVC 크린 장갑, 식품 및 실험용

- 식약처 인증 식품용 장갑 ■ CE Certified ■ Clear & Blue Color
- Meet All Requirements under EN 455 Standard.
- ISO9001 & 13485
- * PVC (Polyvinyl Chloride Resin), Non-sterile
- * Thickness(mm) : 0.06±0.02(Palm); 0.06±0.02(Finger Tip)
- * Elongation : Min. 300%



<L1>

Size	(1) Clear			(2) Blue		
	Cat. No.	Pk. Price, ₩	Cs. Price, ₩	Cat. No.	Pk. Price, ₩	Cs. Price, ₩
X-Small	DH.Glo6031	100ea 7,870	10pk 72,830	DH.Glo6041	100ea 7,870	10pk 72,830
Small	DH.Glo6032	100ea 7,870	10pk 72,830	DH.Glo6042	100ea 7,870	10pk 72,830
Medium	DH.Glo6033	100ea 7,870	10pk 72,830	DH.Glo6043	100ea 7,870	10pk 72,830
Large	DH.Glo6034	100ea 7,870	10pk 72,830	DH.Glo6044	100ea 7,870	10pk 72,830

Articles	Cat. No	Description
----------	---------	-------------



Dust-free Nylon Fabric Glove, Class 1000, Polyurethane Coated, L210~230mm NEW
 Good Breathability, Good for Hand Protection and Grip Performance, **청정 나일론장갑, 클린룸용**

■ 미세한 작업, 클린룸, 반도체 산업, 농업, 임업, 원예산업 등에서의 작업에 적합 ■ 정전기 방지
 * Made by dust-free & soft fabric knitted with 100% Nylon filament yarns
 * Applications : Accurate Assembly, Cleanroom, Semi-conductor Industry, Agriculture, Forestry, Horticulture

(1) Nylon & PU Palm Fit Glove

DH.Glo3001 Nylon & PU Palm Fit Glove, L210mm, Medium
DH.Glo3002 , L230mm, Large

Pk.	Price, ₩	Cs.	Price, ₩
10pair	8,910	50pk	
10pair	8,910	50pk	

(2) Nylon & PU Top Fit Glove

DH.Glo3006 Nylon & PU Top Fit Glove, L210mm, Medium
DH.Glo3007 , L230mm, Large

Pair.	Price, ₩	Pk.	Price, ₩
10pair	6,260	50pk	
10pair	6,260	50pk	

, Cut Resistant 내절단 장갑



350°C Heat & Cut Resistant Glove, with Kevlar® Fiber Surface, Cotton Liner, L330mm NEW
 Usable for Both Hands, Comfortable, Washable, **내열 & 내절단 장갑**

■ 고온에 환경에서 반복으로 사용가능한 내열장갑
 * Kevlar® is a Heat-Resistant and Strong Synthetic Fiber : Usable for Repetitive Operation at Hi-Temperature Environment * Material : Surface (Kevlar® Fiber), Lining (Cotton Liner)
 * Heat-Resistant Temperature : 350°C (18 Seconds)

SL.Glo6631 Gloves, Heat Resistant, L330mm

Pair.	Price, ₩
	90,170

Articles

Cat. No

Description



Natural Rubber Gloves for Glove Box, for Port φ 130~200mm, Length 630~780mm <L2>
Powdered, Thickness 0.4 & 0.6mm, 천연 고무 글러브 박스용 장갑

- SL.Glo6621 Gloves For Glove Box, Thickness 0.4mm, φ 130 × L630mm
- SL.Glo6622 , Thickness 0.6mm, φ 150 × L700mm **New**
- SL.Glo6623 , φ 200 × L780mm **New**

Pair	Price, ₩
	79,330
	56,800
	102,040

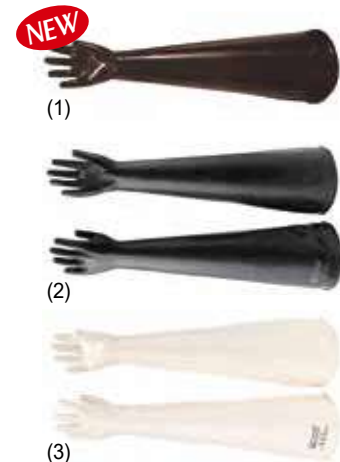

Glove For Glove Box, 3 Different Materials - Neoprene & Butyl & Hypalonized Polyethylene **NEW**
φ 203 × L800mm, Thickness 0.4~0.8mm, 글러브 박스용 장갑

- Neoprene 글러브는 방진·방균용으로서 무균 박스나 드라이 박스에서의 사용에 적합
- Butyl/Hypalon 글러브는 반발력이 매우 작고, 부드럽고 유연, 가스불투과성·액체불투과성이 뛰어남

- SL.Glo6632 Neoprene Glove, Thickness 0.8mm, Black
* Dustproof, Anti Fungus, Suitable for Sterile Box or Dry Box
* Milled Neoprene Gloves for Increased Sensitivity
- SL.Glo6633 Butyl Glove, Thickness 0.6mm, Black
* Made of 2 Layer Materials - Chloroprene/Butyl
* The Highest Permeation Resistance to Vapors and Gases.
* Exceptional Resistance to a Broad Range of Toxic Chemicals
- SL.Glo6634 Hypalonized Polyethylene Glove, Thickness 0.4mm, White
* Resist Ozone and Oxidizing Chemicals
* Superior Chemical and U.V. Resistance.

Pair	Price, ₩
	508,460
	864,380
	694,900

, Living 생활용



PE Disposable Poly Glove, Leakproof, Economical, Sterile or Non-Sterile, 일회용 비닐장갑

- Made of Polyethylene * Ideal for food handling and small parts
- H13.005 PE Poly Gloves, Non-Sterile
- H13.005S , Sterile **New**

Pk.	Price, ₩
100pair	2,520
100pair	8,660



DAEKWANG™ Rubber Glove, with Napping Inner Coated, Fleece Lined, Excellent Heat-Retaining, L420mm **NEW**
Ideal for Industry · Home · Lab-use, with Polyester · PVC Sleeve, Multi-use, Embossing Textured, 기모 고무장갑

- 따뜻한 보온장갑; 장갑내부에 부드러운 기모 안감이 있어 보온력이 우수
- * Material: Layer-Natural Latex/Sleeve-Polyester · PVC * Fleece Lined for Heat

SL.Glo6746 Latex Gloves, Fleece Lined, L420mm, Free

Pair.	Price, ₩	Cs.	Price, ₩
	1,460	100pair	141,240



Foodis™ Sanitary Natural Latex Glove, for Food, Embossing Textured, Antibacterial, Reusable, L310mm
Ideal for Industry · Home · Lab-use, with Long Cuff, Multi-use, 식품용 고무장갑, KS인증상품 **NEW**

- 100% 천연 생고무사용, KS(Korean Industrial Standards)인증상품(KS7805), 무기 항균제첨가, 주부습진예방
- * Comfort and Easy Donning with Flexibility * Excellent Durability

SL.Glo6747 Sanitary Glove, Natural Latex, for Food, L310mm

Pair.	Price, ₩	Cs.	Price, ₩
	1,280	200pair	245,760

, Temp Resistant : High Temp 내열장갑



1000°C Heat Resistant Gloves, Made of Aramid Fiber, Length 350 & 450mm, Flexicible **NEW**
Excellent in Heat Insulation, 내열장갑, 내열성 & 내화학성

- 1000℃의 온도에 견디고, 열전도도가 낮아 단열 효과가 우수
- Material : Para-Aramid Fiber Technora And Silica Fibers Composite Material
- * Heat Resistance Temperature 1000℃

- SL.Glo6635 Glove, 1000°C Heat Resistant, Standard Type, L350mm
- SL.Glo6636 , Long Type , L450mm

Pair.	Price, ₩
	327,930
	450,790

Articles	Cat. No	Description								
	Temres® Moisture Permeable Waterproofing Glove, -40°C +40°C, L270~280mm NEW Cold Resistant, for Low-Temperature, 투습 방수 장갑, 방한/저온용									
	■ 방수성을 유지하면서 습기를 밖으로 배출, 보온성, 저온에서도 유연성 유지 ■ Material : Resin Part - PU (polyurethane), Fiber Part - Acrylic, PU (polyurethane) * As It Releases Moisture Outside While Maintaining Waterproofing, It Helps Prevent Interior Chill * The Glove Linings are a Pile Fabric that Helps Retain Warmth * It Maintains Flexibility Even at Low Temperatures (-40°C).									
	SL.Glo6641 Glove, Moisture Permeable Waterproofing, Medium, 270mm SL.Glo6642 , Large , 275mm SL.Glo6643 , X-Large, 280mm	<L2> <table border="1" style="width: 100%;"> <thead> <tr> <th>Pair.</th> <th>Price, ₩</th> </tr> </thead> <tbody> <tr> <td></td> <td style="text-align: right;">23,960</td> </tr> <tr> <td></td> <td style="text-align: right;">23,960</td> </tr> <tr> <td></td> <td style="text-align: right;">23,960</td> </tr> </tbody> </table>	Pair.	Price, ₩		23,960		23,960		23,960
	Pair.	Price, ₩								
	23,960									
	23,960									
	23,960									

, Working/Industry 산업용

	Sungjin® Cotton Work Glove, with/without PVC Coating Good for Industrial, Construction, Farm and Safe Work, 면/코팅 장갑, 세탁가능																
	<B3>																
	A. All Cotton Glove, High Quality Knitted Cotton <table border="1" style="width: 100%;"> <thead> <tr> <th>Pair.</th> <th>Price, ₩</th> <th>Pk.</th> <th>Price, ₩</th> </tr> </thead> <tbody> <tr> <td>0522-595 (1) Cotton Glove, pair, S(40g)</td> <td style="text-align: right;">210</td> <td>300pair</td> <td style="text-align: right;">55,870</td> </tr> <tr> <td>0522-597 , M(50g)</td> <td style="text-align: right;">250</td> <td>300pair</td> <td style="text-align: right;">65,950</td> </tr> </tbody> </table>		Pair.	Price, ₩	Pk.	Price, ₩	0522-595 (1) Cotton Glove, pair, S(40g)	210	300pair	55,870	0522-597 , M(50g)	250	300pair	65,950			
	Pair.	Price, ₩	Pk.	Price, ₩													
0522-595 (1) Cotton Glove, pair, S(40g)	210	300pair	55,870														
0522-597 , M(50g)	250	300pair	65,950														
B. PVC Palm Coated Glove, Superior Grip, 손바닥 코팅, Blue · Red · White <table border="1" style="width: 100%;"> <thead> <tr> <th>Pair.</th> <th>Price, ₩</th> <th>Pk.</th> <th>Price, ₩</th> </tr> </thead> <tbody> <tr> <td>0419-681 (2) Palm Coated, Red Palm</td> <td style="text-align: right;">320</td> <td>300pair</td> <td style="text-align: right;">84,430</td> </tr> </tbody> </table>		Pair.	Price, ₩	Pk.	Price, ₩	0419-681 (2) Palm Coated, Red Palm	320	300pair	84,430								
Pair.	Price, ₩	Pk.	Price, ₩														
0419-681 (2) Palm Coated, Red Palm	320	300pair	84,430														
C. PVC Whole Coated Glove, 전체 코팅, 목부분은 Natural <table border="1" style="width: 100%;"> <thead> <tr> <th>Pair.</th> <th>Price, ₩</th> <th>Pk.</th> <th>Price, ₩</th> </tr> </thead> <tbody> <tr> <td>0423-116 (3) Whole Coated, pair, Red</td> <td style="text-align: right;">1,250</td> <td>100pair</td> <td style="text-align: right;">114,670</td> </tr> </tbody> </table>		Pair.	Price, ₩	Pk.	Price, ₩	0423-116 (3) Whole Coated, pair, Red	1,250	100pair	114,670								
Pair.	Price, ₩	Pk.	Price, ₩														
0423-116 (3) Whole Coated, pair, Red	1,250	100pair	114,670														
D. PU Top Coated Glove, 손끝 우레탄 코팅 NEW <table border="1" style="width: 100%;"> <thead> <tr> <th>Pair.</th> <th>Price, ₩</th> <th>Pk.</th> <th>Price, ₩</th> </tr> </thead> <tbody> <tr> <td>0419-703 (4) Top Coated Glove, pair, White, S</td> <td style="text-align: right;">450</td> <td>10pair</td> <td style="text-align: right;">4,150</td> </tr> <tr> <td>0419-701 , M</td> <td style="text-align: right;">450</td> <td>10pair</td> <td style="text-align: right;">4,150</td> </tr> <tr> <td>0419-702 , L</td> <td style="text-align: right;">450</td> <td>10pair</td> <td style="text-align: right;">4,150</td> </tr> </tbody> </table>		Pair.	Price, ₩	Pk.	Price, ₩	0419-703 (4) Top Coated Glove, pair, White, S	450	10pair	4,150	0419-701 , M	450	10pair	4,150	0419-702 , L	450	10pair	4,150
Pair.	Price, ₩	Pk.	Price, ₩														
0419-703 (4) Top Coated Glove, pair, White, S	450	10pair	4,150														
0419-701 , M	450	10pair	4,150														
0419-702 , L	450	10pair	4,150														

	ORUN™ Comfort Multiuse Nylon Glove, Grip Tap Coated, Touch Screen, Palm Dot-type, L210~240mm NEW Ideal for Light Working/Leisure/Camping, 편리성 다용도 나일론 장갑, 모바일폰 터치가능, 통기성/신축성/그립성 우수																	
	■ 다용도; 실내외 경량작업/레저/등산 캠핑용 등의 경제성 안전장갑, 스마트폰 터치와 우수한 그립성 * PU(Polyurethane) Top Fit Coating * Non-Slip with PVC Palm Dot * Soft and Stretchy * Breathable, Anti-Sweat with Nylon Fiber * Ideal Indoor Operation, Light General Handling, Leisure & Cashier <B3> * Conductive Cotton Yarn on Top Fit Conveys Electrical Impulse to the Touchscreen																	
	SL.Glo6721 Nylon & PU Top Fit Glove, PVC Dot-type, Grey, L210mm, Small SL.Glo6722 , L230mm, Medium SL.Glo6723 , L240mm, Large	<table border="1" style="width: 100%;"> <thead> <tr> <th>Pair.</th> <th>Price, ₩</th> <th>Cs.</th> <th>Price, ₩</th> </tr> </thead> <tbody> <tr> <td></td> <td style="text-align: right;">1,350</td> <td>120pair</td> <td style="text-align: right;">155,930</td> </tr> <tr> <td></td> <td style="text-align: right;">1,350</td> <td>120pair</td> <td style="text-align: right;">155,930</td> </tr> <tr> <td></td> <td style="text-align: right;">1,350</td> <td>120pair</td> <td style="text-align: right;">155,930</td> </tr> </tbody> </table>	Pair.	Price, ₩	Cs.	Price, ₩		1,350	120pair	155,930		1,350	120pair	155,930		1,350	120pair	155,930
	Pair.	Price, ₩	Cs.	Price, ₩														
	1,350	120pair	155,930															
	1,350	120pair	155,930															
	1,350	120pair	155,930															

	ORUN™ High Elastic Nylon Gloves, PU Palm Coated, Minimize Hand Fatigue, L225~240mm NEW Dust · DMF Free, Breathable, Anti-slippery, 18Guage, 고탄력 나일론 장갑, PU코팅																	
	■ 18G 촘촘한 나일론 내피와 PU(Polyurethane) 코팅으로 착용감이 우수하고, 먼지가 잘 묻지 않음 ■ Usability Available in a Wide Range, Including Agriculture, Gardening, Carpentry, Precision Work, and General Work. <B3> * Prevent Fingerprints from Getting on the Surface when Handling Work																	
	SL.Glo6701 Nylon & PU Coated Blue Glove, L225mm, Small SL.Glo6702 , L230mm, Medium SL.Glo6703 , L240mm, Large	<table border="1" style="width: 100%;"> <thead> <tr> <th>Pair.</th> <th>Price, ₩</th> <th>Cs.</th> <th>Price, ₩</th> </tr> </thead> <tbody> <tr> <td></td> <td style="text-align: right;">1,190</td> <td>120Pair</td> <td style="text-align: right;">137,280</td> </tr> <tr> <td></td> <td style="text-align: right;">1,190</td> <td>120Pair</td> <td style="text-align: right;">137,280</td> </tr> <tr> <td></td> <td style="text-align: right;">1,190</td> <td>120Pair</td> <td style="text-align: right;">137,280</td> </tr> </tbody> </table>	Pair.	Price, ₩	Cs.	Price, ₩		1,190	120Pair	137,280		1,190	120Pair	137,280		1,190	120Pair	137,280
	Pair.	Price, ₩	Cs.	Price, ₩														
	1,190	120Pair	137,280															
	1,190	120Pair	137,280															
	1,190	120Pair	137,280															

Articles

Cat. No

Description



ORUN™ General Purpose Nylon Gloves, Reusable, Anti-slip, L200~240mm **NEW**
 Ideal for Touch Screen Device, Abrasion Resistant, 작업용 나일론 장갑, 미끄럼방지코팅

- 우수한 통기성, 편안한 착용감, 마모가 빠른 손가락 끝부분을 이중 편직으로 구성함
- * Excellent Ventilation, Comfortable Fit * Finger-Stiffened Double-Piece Fabrication
- * Less Tired even after Wearing it for a Long Time by Remembers the Shape of the Hands.
- * (2) NBR Coated Gloves - Smart Device Touchable, and Oil Resistance.

- Material : Microfiber with NBR(Acrylonitrile Butadiene Rubber) Coating Palm



(1) Latex Coated Gloves

SL.Glo6711	Glove, L210mm, Small	Pair. Price, ₩
SL.Glo6712	, L230mm, Medium	1,680
SL.Glo6713	, L240mm, Large	1,680

<B3>

(2) NBR Coated Gloves, 스마트폰 터치 가능

SL.Glo6717	Glove, L200mm, Small	Pair. Price, ₩
SL.Glo6718	, L215mm, Medium	1,930
SL.Glo6719	, L225mm, Large	1,930



ORUN™ High Strength Handling NBR Coated Gloves, Excellent Thermal for Winter, L230~240mm **NEW**
 Ideal for Touch Screen Device, Anti-Slip, 고강도 작업용 NBR폼코팅 장갑, 겨울용, 스마트폰 터치 가능

- Made in Korea ■ 초극세사 날개원단 사용, 내피의 보온성이 우수하여 동계용으로 적합
- 부드러운 착용감, 스마트기기 터치가능, 미끄럼방지 표면처리, 높은 내구력의 특징을 가지고 있음
- * Material : Microfiber with NBR(Acrylonitrile Butadiene Rubber) Coating Palm
- * Ideal for Outdoor Operation, High Strength Handling, Logistics Working, and Winter Activity
- * Oil-resistant * Excellent Durability & Soft Wearability

<B3>

SL.Glo6737	Glove, NBR Coating Palm, for Winter, 230mm, Small	Pair. Price, ₩
SL.Glo6738	, 235mm, Medium	3,040
SL.Glo6739	, 240mm, Large	3,040

Cs. Price, ₩	Pair. Price, ₩
120pair 352,520	3,040
120pair 352,520	3,040
120pair 352,520	3,040



ORUN™ High Level Functional Glove, NBR Palm Coated, Prevent for Abration & Scratch, Reusable, L300mm **NEW**
 Oil & Water Resistant, Durability, Anti-slip, Comfortable Grip, Multi-use, 공업용 NBR코팅 장갑, 내유·방수용

- 내유성, 내수성이 뛰어나 마모, 굽힘 등에 강함 ■ 니트릴 폼 코팅으로 미끄럽지 않은 최상급 그립감 제공
- * Ideal for Fishery Industry, Oil Treating, Machinery, Deck Work, Construction
- * Material : Layer-Cotton, Polyester/Outer-NBR(Acrylonitrile Butadiene Rubber) Coating

<B3>

SL.Glo6731	Glove, NBR Coating Palm, L300mm, L	Pair. Price, ₩
SL.Glo6732	, XL	4,160
SL.Glo6733	, XXL	4,160

Cs. Price, ₩	Pair. Price, ₩
120pair 483,030	4,160
120pair 483,030	4,160
120pair 483,030	4,160

Wellz 알곤용접장갑(양피), Argon Welding Glove 다국적



- 고급 양피(Sheep-Skin)를 사용하여 우수한 착용감
- 내피 안감처리로 땀 흡수(Cotton Inside Lining) ■ 벨크로 방식으로 편리한 탈부착
- 이중 덧댐으로 더욱 강화된 내마모성

<B3>

ORDER NO.	MODEL NO.	PRICE, ₩ Ea.	색상	포장단위 Ea. / Pk.
(1) 0460-490	KGA-240	5,200/pair	갈색	1 / 10
(2) 0431-106	KGW-260	3,920/pair	회색	1 / 10

Wellz 기본용접장갑, Basic Welding Glove 다국적



- 내피 안감처리로 땀 흡수 (Cotton Inside Lining)

<B3>

ORDER NO.	MODEL NO.	PRICE, ₩ Ea.	색상	포장단위 Ea. / Pk.
0420-995	KGW-330X	4,010/pair	회색	1 / 10

Articles	Cat. No	Description
----------	---------	-------------

SAUTER® Digital Professional Shore Hardness Tester Set, Measurement of Penetration, Hardness-type Shore A · Shore A0 · Shore D
 With Large · Display Backlight · Hand Carrying Case, High Precise, 디지털 프로페셔널 쇼어 경도측정기 세트 **NEW**



- Supplied by SAUTER® in Germany
- A Pin Made of Hardened Metal and of a Defined Shape is Held by a Spring and is then Pushed into the Test Item. Depending on the Depth of the Penetration, the Material Tested is either Harder and Softer.
- * Shore A : Suitable for Rubber, Elastomers, Neoprene, Silicone, Vinyl, Soft Plastics, Felt, Leather and Similar Material
- Shore D : Suitable for Plastics, Formica, Epoxides, Plexiglass etc.
- Shore A0 : Suitable for Foam, Sponge etc.
- * Particularly Recommended for Internal Comparison Measurement. Standard Calibrations e. g. to DIN 7619-1 are not Possible, Because of Very Narrow Standard Tolerance
- * Tolerance : 1 % of [Max] * Permissible Ambient Temperature 0 °C~50 °C
- * Measuring Frequency : 30 Display updates Per Minute * Material Thickness of the Sample, Min. 4 mm
- * Optional Software and RS-232 Cable : Transfer Via RS-232 to the PC for Recording, Printing and Microsoft Excel®
- * Complete Set : Main Unit + Test Block + Operation Manual + Carrying Case
- * Battery : 2 × 1.5 Volts "AAA"

Specifications & Ordering information <L1>

Cat. No.	Hardness type	Measuring Range Max HS	Readout d HS	Dimensions & Weight (mm/g)	Set. Price, ₩
SA.HDA100.1	Shore A	100 HA	0.1 HA	65 × 38 × h162 mm / 173g	659,590
SA.HD0100.1	Shore 0	100 H0	0.1 H0		659,590
SA.HDD100.1	Shore D	100 HD	0.1 HD		659,590

Optional Comparison Plates and Software Set



	Ea. Price, ₩
SA.AHBA.01 Optional ; 7 Hardness Comparison Plates for Shore A, Tolerance up to ± 2 HA	178,460
SA.AHBD.01 ; 3 Hardness Comparison Plates for Shore D, Tolerance up to ± 2 HA	140,900
SA.ATC.01 ; Data Transfer Software and RS-232 Cable Set	169,070
SA.TI.ACL ; Test Stand for HDA and HD0	527,650
SA.TI.DL ; Test Stand for HDD	676,210

※ Optional Level Operated Test Stand : Please See "SA.TI.ACL, SA.TI.DL" on the Next Page!

SAUTER® Analog Compact Handheld Shore Hardness Tester Set, Measurement of Penetration, Hardness-type Shore A · Shore A0 · Shore D
 With Drag Indicator · Hand Carrying Case, Measuring Tips are not Interchangeable, 아날로그 컴팩트 쇼어 경도측정기 세트 **NEW**



- Supplied by SAUTER® in Germany
- Tips Made of Hardened Metal and of a Defined Shape is Held by a Spring and is then Pushed into the Test Item. Depending on the Depth of the Penetration, the Material Tested is either Harder and Softer.
- * Shore A : Suitable for Rubber, Elastomers, Neoprene, Silicone, Vinyl, Soft Plastics, Felt, Leather and Similar Material
- Shore D : Suitable for Plastics, Formica, Epoxides, Plexiglass etc.
- Shore A0 : Suitable for Foam, Sponge etc.
- * Particularly Recommended for Internal Comparison Measurement. Standard Calibrations e. g. to DIN 7619-1 are not Possible, Because of Very Narrow Standard Tolerance
- * Tolerance : 3 % of [Max] * Material Thickness of the Sample, Min. 4 mm
- * Max Mode : Record the Peak-value Using the Drag Pointer
- * Complete Set : ① Hardness Tester, ② Test Block, ③ Manual, ④ Carrying Case

Specifications & Ordering information <L1>

Cat. No.	Hardness type	Measuring Range Max HS	Readout d HS	Dimensions & Weight (mm/g)	Set. Price, ₩
SA.HBA100.0	Shore A	0~100 HA	1.0 HA	60 × 25 × h115 mm / 160g	184,700
SA.HB0100.0	Shore A0	0~100 HA0	1.0 HA0		237,480
SA.HBD100.0	Shore D	0~100 HD	1.0 HD		246,250



Optional Comparison Plates and Software Set



	Ea. Price, ₩
SA.AHBA.01 Optional ; 7 Hardness Comparison Plates for Shore A, Tolerance up to ± 2 HA	178,460
SA.AHBD.01 ; 3 Hardness Comparison Plates for Shore D, Tolerance up to ± 2 HA	140,900
SA.TI.AC ; Test Stand for HBA and HB0	450,800
SA.TI.D ; Test Stand for HBD	563,500

※ Optional Level Operated Test Stand : Please See "SA.TI.ACL, SA.TI.DL" on the Next Page!

SAUTER® Optional Lever Operated Test Stand, for Hardness Testing with Base Glass Plate, 정밀 조정 경도시험 스탠드 **NEW**

NEW



- Supplied by SAUTER® in Germany
- Combined with this Stand, Tests can be Performed more Stable and Accurate, up to 25%
- * Screw to Screw on to the TI : M7 Fine Thread
- * Robust Design for Precise Measuring
- * Glass Plate : High Measurement Accuracy by means of Superior Hardness of the Glass Plate

Specifications & Ordering information

<L1>

Cat. No.	Suitable for	Length of column (mm)	Control Weight (kg)	Dimensions & Weight (mm/g)	Ea. Price, ₩
SA.TI.AC	SA.HBA100.0 SA.HB0100.0	245 mm	1 kg	150 × 110 × h330 mm / 4.5 kg	450,800
			5 kg	150 × 110 × h400 mm / 8.5 kg	563,500
SA.TI.ACL	SA.HDA100.1 SA.HD0100.1	300 mm	1 kg	150 × 110 × h380 mm / 4.5 kg	527,650
			5 kg	150 × 110 × h450 mm / 8.5 kg	676,210



Figure ; Test Stand with Shore Hardness Tester

SAUTER® Premium Mobile Leeb Hardness Tester Set, for All Metallic Samples, with Type-D External Impact Sensor **NEW**

Measurement Value HRA · HRB · HRC · HB · HL · HS · HV, with Hardness Test Block · Hand Carrying Case, 프리미엄 리브 경도측정기, 테스트 블록 포함

NEW



Premium Mobile Leeb Hardness Tester for Metal

- Supplied by SAUTER® in Germany
- The Rebound of Impact Body Leads to a Deformation of the Upper Surface, which Result in a Loss of Kinetic Energy. This Loss of Energy is Determine by Measuring the Speed and here from the Leeb Hardness Value(HL) is Calculated.
- * Measurement Value Display: Rockwell (HRA, HRB, HRC), Vickers (HV), Shore (HS), Leeb (HL) and Brinell (HB)
- * Internal Memory for up to 600 Data Groups, with up to 32 Values per Group Forming the Average Value of the Group
- * Mini Statistics Function : Displays the Measured Result, the Average Value, the Impact Direction, Date and Time
- * The Measuring Result is Automatically Converted into All Hardness Unit
- * Measuring with Tolerance Range : Upper and Lower Limiting can be Programmed Individually
- * With USB Interface : Multiple Communication Modes are Adapted to Meet Customized Requirements of Various Users
- * Required Minimum Specification of Sample : Thickness 8mm, Weight 3kg and Radius 50 mm (with Support Ring : 10 mm)
- * Including Hardness Test Block, Hardness Approx. 800 HLD * Precision : ± 1 % at 800 HLD
- * All Measurement Directions Possible 360° * External Impact Sensor Standard (Type D)
- * Battery : 2 × 1.5 V AA, Operating Time up to 200 hours * Permissible Ambient Temperature -10℃ +40℃
- * Complete Set : Main Unit + D-type Sensor + Supporting Ring + Clean Brush +Screw Driver + Hardness Test Block + Communication Cable

Specifications & Ordering information

<L1>

Cat. No.	Sensor	Measuring Range Max (HL)	Readout d (HL)	Dimensions & Weight (mm/g)	Set. Price, ₩
SA.HK.DB	Type D	170-960 HL	1 HL	31 × 82 × h132 mm / 0.45kg	2,423,030



Fig. ; Hardness Comparison Block (Included)



Carrying Case

Optional Accessories

Accessories	Ea. Price, ₩
SA.AHMR.01 ; Support Rings for Secure Positioning	601,080
SA.AHMO.D01 ; Impact Body Type D, Net Weight Approx. 5.5g, Hardness ≥ 1600 HV, Tungsten Carbide, Impact Ball φ3 mm, in Accordance with the Standard ASTM A956-02	216,030
SA.AHMR.D ; External Impact Sensor Type D, SAUTER	544,720
SA.HMO.A04 ; Connection Cable Hardness Tester / Impact Sensor	178,460
SA.AHMO.D02 ; Test Block Type D/DC, φ90 mm (± 1 mm), Net Weight < 3kg, Hardness Range 790 ± 40 HL	356,890
SA.AHMO.D03 ; Test Block Type D/DC, φ90 mm (± 1 mm), Net Weight < 3kg, Hardness Range 630 ± 40 HL	356,890
SA.AHMO.D04 ; Test Block Type D/DC, φ90 mm (± 1 mm), Net Weight < 3kg, Hardness Range 530 ± 40 HL	356,890

SAUTER® Advanced Mobile Leeb Hardness Tester Set, for All Metallic Samples, with Type-D External Impact Sensor NEW

Measurement Value MPa · HRB · HRC · HB · HL · HSD · HV, with Hardness Test Block · Hand Carrying Case, 고급 리브 경도측정기 세트, 테스트 블록 포함



Advanced Mobile Leeb Hardness Tester for Metal

- Supplied by SAUTER® in Germany
- The Rebound of Impact Body Leads to a Deformation of the Upper Surface, which Result in a Loss of Kinetic Energy. This Loss of Energy is Determine by Measuring the Speed and here from the Leeb Hardness Value(HL) is Calculated.
- * Measurement Value Display : Rockwell (HRB, HRC), Vickers (HV), Brinell (HB), Shore (HSD), Leeb (HL) and Tensile Strength (MPa)
- * Internal Memory for up to 9 Data Groups, with up to 9 Values per Group Forming the Average Value of the Group
- * The Measuring Result is Automatically Converted into All Hardness Unit.
- * Required Minimum Specification of Sample : Thickness 8mm, Weight 3kg and Radius 50 mm (with Support Ring : 10 mm)
- * Including Hardness Test Block, Hardness Approx. 790 ± 40 HL
- * Precision : 1 % at 800 HLD (± 6 HLD) * Measuring Range Tensile Strength : 375-2639 MPa (steel)
- * All Measurement Directions Possible 360° * Battery : 3 × 1.5 V AAA, Operating Time up to 30 hours
- * Complete Set : Main Unit + D-type Sensor + Supporting Ring + Clean Brush + Charger + Hardness Test Block + Manual + Hand Carrying Case

Specifications & Ordering information <L1>

Cat. No.	Sensor	Measuring Range Max HL	Readout d HL	Dimensions & Weight (mm/kg)	Set. Price, ₩
SA.HMM.NP	Type D	170-960	1	150 × 30 × h80 mm / 0.2kg	1,634,150



Figure ; Test Block for Calibration (Included)



Carrying Case

Optional Accessories

Optional	Ea. Price, ₩
SA.HMM.A02 ; Connection Cable, without Impact Sensor	197,250
SA.AHMR.01 ; Attachment Rings for Secure Positioning	601,080
SA.AHMO.D01 ; Impact Body	216,030
SA.AHMO.D02 ; Test Block Type D/DC, φ 90 mm (± 1 mm), Net Weight < 3 kg, Hardness Range 790 ± 40 HL	356,890
SA.AHMO.D03 ; Test Block Type D/DC, φ 90 mm (± 1 mm), Net Weight < 3 kg, Hardness Range 630 ± 40 HL	356,890
SA.AHMO.D04 ; Test Block Type D/DC, φ 90 mm (± 1 mm), Net Weight < 3 kg, Hardness Range 530 ± 40 HL	356,890

SAUTER® Premium UCI(Ultrasonic Contact Impedance) Hardness Tester Set, for All Small Metallic Samples, with UCI Sensor Unit NEW

Ideal for Obtaining Rapid and Precise Result, with Hardness Test Block · Hand Carrying Case, 초음파 경도측정기 세트, 테스트 블록 포함



UCI Hardness Tester for Metal

- Supplied by SAUTER® in Germany
- Advantages : ① The Testing by Small Penetration is almost Non-destructive
② Demanding Optical Measuring is not Required
③ The High Requirements on the Weight of the Test Object can be widely Omitted
- * Standards : DIN 50159-1-2008; ASTM-A1038-2005; JB/T9377-2013
- * Used for Measuring Small forgings, Castings, Welding Points, Punched Parts, Casting tools, Ball Bearings and the Flanks of Gear Wheels As Well As for Measuring the Influence of Warmth or Heat.
- * Measurement Data Memory Saves up to 1000 Measurement Group each with 20 Individual Value
- * Can be Set to Both Standard Hardness Test Blocks and also to up to 20 Reference Calibration Values
- * Measuring Ranges : HRC: 20,3-68; HRB: 41-100; HRA: 61-85,6; HV: 80-1599; HB: 76-618; Tensile Strength: 255-2180 N/mm²
- * Precision : ± 3 HV; ± 1,5 HR; ± 3 % HB
- * Measuring Time : Adjustable From 1-5 sec
- * Display Units : HRC, HV, HBS, HBW, HK, HRA, HRD, HR15N, HR30N, HR45N, HS, HRF, HR15T, HR30T, HR45T, HRB.
- * Complete Set : Display Unit + UCI Sensor Unit + Software to Transfer the Saved Data to the PC + USB Charger + Battery + Hardness Test Block + Manual + Hand Carrying Case

Specifications & Ordering information <L1>

Cat. No.	Hardness scale	Minimum Weight of Test Item (g)	Minimum Thickness of Test Item (mm)	Dimensions & Weight (mm/kg)	Permissible Ambient Temperature	Set. Price, ₩
SA.HO1K	HV 1	300	2	28 × 83 × h160 mm / 0.7kg	-10 °C + 40 °C	9,220,790
SA.HO2K	HV 2	300	2			9,220,790
SA.HO5K	HV 5	300	2			9,220,790
SA.HO10K	HV 10	300	2			9,220,790



Carrying Case

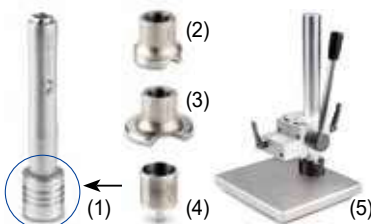

Optional Accessories

Optional	Ea. Price, ₩
SA.AHMO.D ; External Impact Sensor Type D	638,640
SA.HO.A04 ; (1) Support Ring, Flat	864,040
SA.HO.A05 ; (2) , Small Cylinder	845,250
SA.HO.A06 ; (3) , Large Cylinder	845,250
SA.HO.A07 ; (4) Deep-hole Protective Cover	441,410
SA.HO.A08 ; (5) Test Stand for Repeatable Movements, Stable and Precise Measuring	2,798,690

Articles

Cat. No

Description

NEW

Medicaluse



3M[®] Cavilon[™] No-Rinse Skin Cleanser Sprayer, pH Balanced, Hypoallergenic, 236ml, *Medicaluse*
Daily Incontinence Skin Care, Control Odor, 노-린스 스킨 클렌저 스프레이 NEW

- 자극 없는 pH밸런스 스킨 클렌저; 실금 및 당뇨 환자의 소변, 대변 및 체액을 피부 자극없이 제거, 물로 따로 헹구지 않아도됨, 보습성 유지
- **No-Rinse Solution that Gently Cleans Skin without Irritation**
- **Protecting at-Risk Skin from Damage Associated with incontinence**
- **Using for Diabetic Foot Care, Dry Skin, Maceration, Irritation around a Peri-tube Opening, and Pressure Ulcers**
- * Trigger Sprayer for Ease of Use * Ideal for Cleaning All Body Fluid Types Including Urine and Stool
- * pH Balanced & Hypoallergenic Formula for Gentle and Effective Cleansing
- * Can be Used on Both Intact and Irritated Skin
- * Helps to Control Odor for Improved Environment and Patient Well-Being
- * Contains Ingredients That Help Moisturize and Condition the Skin as it Cleans

<M4>

3M.07.3380 No-Rinse Skin Cleanser, Spray-type, 236ml

Ea.	Price, ₩	Cs.	Price, ₩
	13,760	12ea	160,060

NEW

Medicaluse



3M[®] Cavilon[™] Durable Barrier Cream, Fragrance-Free Barrier Film, Moisturizing, 92ml, *Medicaluse*
Long-lasting Protection, Hypoallergenic, CHG Compatible, 듀리블 배리어 크림, 피부 보습 및 코팅 NEW

- 피부 보습 및 보호 코팅 크림; 보호막 형성, 대소변이 피부에 직접 닿는 것을 방지, 도포후에 테이프 or 드레싱의 점착력을 방해하지 않음
- **Clinically Proven Protection - Hypoallergenic Formula Contains Dimethicone for Skin Protection**
- **Protection Against Incontinence-Associated Dermatitis (IAD)**
- * Durable and Concentrated * Allows Tapes and Dressings to Adhere
- * Does Not Clog Briefs or Diapers * Long Lasting, Resists wash-off
- * Moisturizing Severely Dry Skin * Easy to Care & Saving Time and Effort



<M4>

3M.07.3392G Barrier Cream, 92ml

Ea.	Price, ₩	Cs.	Price, ₩
	23,380	12ea	272,100

NEW



(1) Skin Softener (2) Emulsion

Mamonde[®] Skin Softener & Emulsion, High Moisturizing Effect, 150 & 200ml, 마몽드 스킨/로션 NEW

- 무공화의 강력한 보습 인자로 피부 강화 효능을 극대화
- 끈적임이 없고 이중보습으로 촉촉한 피부를 유지
- * High Moisturizing Effect * Hypoallergenic * Non-sticky
- * Fast Absorption * Long Lasting * Double Moisturizing Care

<B3>

DH.Bod1001 (1) Skin Softener, 200ml

DH.Bod1002 (2) Emulsion, 150ml

Ea.	Price, ₩
	23,300
	26,210

NEW

Body Lotion



NIVEA[®] Body Lotion, For all Skin Use, Non-sticky, 125ml, 니베아 바디로션 NEW

- 해양 미네랄 성분 함유
- 끈적임이 없고 빠르게 흡수되어 피부를 부드럽고 촉촉하게 유지
- * Hypoallergenic * Non-sticky * Long Lasting
- * Deep Moisturizing, Quick Absorption, Smoother Skin

<B3>

DH.Bod1005 Body Lotion, 30×55×h150mm, 125ml

Ea.	Price, ₩
	4,370

NEW

Hand Cream



ATRIX[®] Hand Cream, Hypoallergenic, Non-sticky, 75ml, 아트릭스 핸드크림 NEW

- 식물보습성분 알로에 베라와 고농축 글리세린 함유
- 이중보습 및 보호막을 형성하여 손피부를 촉촉하게 가꾸어주며 피부손상 방지
- * Skin Damage Prevention * Double Moisturizing Care
- * Moisturizing and Protecting Skin * Deep moisturizing effect

<B3>

DH.Bod1007 Hand Cream, 60×40×h120, 75ml

Ea.	Price, ₩
	4,370

NEW

Hair Spray



Hair Spray, Strong, Long-lasting, Reshapeable, Herb Scent, 300ml, 꽃들든남자 헤어스프레이 NEW

- Floral Complex(로즈마리, 백합, 국화, 세이지, 팬지, 카모마일, 라벤더 추출물)이 모발에 영양을 공급
- 세라마이드 성분이 함유되어 모발을 촉촉하게 보호
- 강력한 세팅효과로 오랫동안 스타일 유지 가능
- * Easy to use * Strong Hold, Soft, Smooth and will Fix Hair

<B3>

DH.Bod1009 Hair Spray, Herb Scent, 300ml

Ea.	Price, ₩
	5,100

Articles	Cat. No	Description
----------	---------	-------------

M.I.Tech® Blood Glucose Monitoring System “RAPICHECK & STRIP”, *Medicaluse* NEW

High Accuracy, Ergonomic Design, Code-free, 20~600mg/dL, Test Time 5sec, 0.5µl Blood Sample, 혈당측정기 세트, 채혈침 포함

NEW



RAPICHECK Meter



RAPICHECK Test Strips (Spare)



Blood Glucose Monitoring System

Medicaluse

- Made in Korea
- Based on ISO15197:2013
- 7, 14, 30일 평균 데이터
- 적은 채혈량으로 빠른 측정
- 커다란 화면(2.6인치)
- 국제표준규격 ISO15197:2013
- Complete Set with : ① RAPICHECK Meter, ② Lancing Device, ③ 10 Lancets, ④ Carrying Case, ⑤ Lithium Battery, ⑥ User's Guide, ⑦ Log Book

* Simple to use for self test * Auto Turn off

Specifications & Ordering information

<M1>

Spec.	Model	RAPICHECK
Detection Method		Amperometry : Generated by Oxidation of Reduced Mediator
Calibration Method		Plasma
Enzyme		Glucose Oxidase
Mediator		Potassium Ferricyanide (III)
Electrode		Carbon Electrode
Test Range		20~600 mg/dL (1.1~33.3mmol/L)
Hematocrit Range		20~60 %
Test Time		5 seconds
Sample Volume		0.5µl / Capillary whole Blood
Temp & Humidity Range		50°F~104°F / 10°C~40°C / 10~90 %
Period of Usage after Open		3 months after Opening the Strips
Coding		No Coding
Memory Capability		1000 Tests
Power		One CR2032 Lithium Battery
Battery Life		1000 Tests
Size (w×d×h)		49.0×94.2×18.0mm
Weight		57g
Warranty		5 years
Cat. No.		DM.12.1001
Price, Set. ₩		22,630

Spare Accessory

DM.12.1002 RAPICHECK Test Strips

Pk.	Price, ₩
50ea	10,310

NEW



① Individual Package



② 100pads

③ 200pads

Medicaluse

MediTop® Disposable Ethanol Swab, for Skin Disinfection, 30×30 & 40×40mm, *Medicaluse* With 78.85% Ethyl Alcohol, 일회용 에탄올 스왑, 멸균/비멸균 소독솜 NEW

- Made in Korea
- Made of Rayon Staple Fiber
- Made of Rayon Staple Fiber Containing 78.85% Ethanol Alcohol
- Ideal for Disinfection of Wound & Medical Equipment
- * Easier and more Comfortable to Use for Disinfection
- * Easy to Carry
- * No Skin Irritation
- * for External Use Only
- * Approx Size Swab : 30×30 & 40×40mm

<M3>

(1) Sterile, 78.85% Ethanol Swab

DM.13.1003 ① Ethanol Swab, Sterile, Individual Package, 30×30mm
DM.13.1004 ② , 100pads/Package, 40×40mm

Pk.	Price, ₩	Cs.	Price, ₩
100pads	2,240	60pk	
100pads	1,210	100pk	

(2) Non-Sterile, 78.85% Ethanol Swab

DM.13.1005 ① Ethanol Swab, Non-Sterile, Individual Package, 30×30mm
DM.13.1006 ② , 100pads/Package, 40×40mm
DM.13.1007 ③ , 200pads/Package, 40×40mm

Pk.	Price, ₩	Cs.	Price, ₩
100pads	2,070	60pk	
100pads	1,040	100pk	
200pads	1,390	48pk	

MEDITEC® Automatic Digital Blood Pressure Monitor/Sphygmomanometer "MD", Medicaluse **NEW**

With Large LCD Display, Two Group Memory Function, One Touch Type, 20~285mmHg, 30~150 bpm, **자동 전자 혈압계, 휴대용/가정용**



- 대형 LCD화면의 사용이 간편한 원터치 타입으로 최고 & 최저 혈압 및 맥박을 동시 측정가능
- 2 메모리 그룹 최대 80회 측정치를 기억하여 2인 동시 혈압관리 가능
- * Large LCD Display with Max., Min. Blood Pressure and Pulse Displayed in 2 Line (MD-2070 : 3 Line)
- * Automatic Power-off Function when not Used for 3 minute
- * Including Carrying Case only for "MD-2070"

Specifications & Ordering information

<M3>

Spec.	Model	(1) "MD-2060"	(2) "MD-2070" with Large LCD Display & Carrying Case
Measuring Method		Oscillometric	
Pressurization		Automatic Pressurization	
Depressurizing Method		Deflation(Rapid) : Automatic Rapid Exhaust Deflation (Measurement) : Automatic pressure reduction	
Measuring Range(LCD Display)		Pressure : 20~285mmHg, Pulse : 30~150bpm	
Accuracy		Pressure : ± 3mmHg, Pulse : within ± 5%	
Memory Function		2 Memory Group, up to 80 Measurement	
Overall Dimension & Weight		131 × 117 × h70mm, 396g	
Power Adaptor		DC 6V Adapter(220v/60Hz), or AA Battery : 4ea DC 6V	
Cat. No.		DM.12.1003	DM.12.1004
Price, Each. ₩		58,210	86,520

Spirit® Portable Aneroid Blood Pressure Monitor/Sphygmomanometer, 0~300mmHg, Medicaluse **NEW**

With Scale Glow in Dark & Meta Gauge, For Use with Stethoscope, **아네로이드식 휴대용 혈압계**



- 아네로이드식의 휴대가 간편한 혈압계로 병원 및 일반 가정에서 주로 사용
- High Quality with Competitive Value Aneroid Sphygmomanometer
- * Scale Glow-in-Dark
- * White Reading Scale is Available
- * Measurement Range : 0~300mmHg
- * Cuff Size : Approx. 510 × 142mm
- * Including a Portable Storage Pouch.
- * Inflation Method : Inflation and Air Release by Manual
- * Gauge Dimension : 57 × 75mm
- * Cuff Material : Nylon

<M2>

DM.12.1005 Mercury-free Blood Pressure Monitor, 0~300mmHg

Ea.	Price, ₩
	42,860

InBody® Upload-pressurized Automatic Sphygmomanometer "BPBIO320 & BPBIO320N", Medicaluse **NEW**

0~300mmHg(Pressure), 30~240 bpm(Pulse), with Table Stand & Stool, **상향 가압식 자동혈압계, 테이블/의자포함**



(1) "BPBIO320" With Printer
(2) "BPBIO320N" Without Printer



- Made in Korea
- 7인치의 넓은 갈라 LED화면으로 모든 결과값(최고혈압, 최저혈압, 맥박수) 바로 확인가능
- LED점등으로 측정상태 안내
- 심박수에 따라 최고 혈압까지 가압하여 재는 방식
- * Two Different Printing Options Available (Graph printing, 3 Line printing)
- * Wide LED Screen for Easy Checking of all Results (Systolic, Diastolic, and Pulse Rate)
- * Emergency Closing During Measuring Process if Necessary

Specifications & Ordering information

<M6>

Spec.	Model	(1) "BPBIO320" With Printer	(2) "BPBIO320N" Without Printer
Measuring Method		Oscillometric	
Pressurizing Method		Automatic Pressurization by Air Pressurization Speed Controller Micro Pump	
Depressurizing Method		Exhaust by Micro Valve	
Cuff		Pressurizing Belt Method by Gear Motor, Automatic Operation	
Measurement Range		0~300mmHg(Pressure), 30~240 bpm(Pulse)	
Accuracy		± 3mmHg(Pressure), ± 2%(Pulse)	
Measurement Result		Systolic & Diastolic Blood Pressure, Pulse	
Measurement Duration		Average 40sec.(30 ~ 60sec. Depending on the Pulse Rate or Blood Pressure)	
Power Source & Consumption		AC 100~120 / 200~240V, 50/60Hz, 60VA	
Dimensions & Weight		489 × 409 × h284 mm, 9kg	
Operation Environment		10℃~40℃(50°F~104°F), 30~75%RH, 70~106kPa	
Storage Environment		-20℃ + 50℃(-4°F + 122°F), 10 ~ 95%RH, 50~106kPa(No Condensation)	
Cat. No.		DM.12.1006	DM.12.1007
Price, Set. ₩		1,291,070	1,224,520

Articles

Cat. No

Description

NEW



InBody® Mobile Auto-Stadiometer “BSM370”, Measure Height · Weight · BMI · Obesity **NEW**
 With Wheels for Carrying, 90~200cm, 2~250kg, **접이식 이동형 신장/체중/체지방/비만도 측정기**

- **Made in Korea**
- 측정단위가 세분화 된 정밀한 측정센서의 신장 측정값 제공
- 접었을 시에는 1.35m의 컴팩트한 사이즈로 원거리 이동이 가능
- * Wheels for Mobility
- * Installation does not Require Any Tools

Specifications & Ordering information <M6>

Spec.	Model	“BSM370”
Measuring Range		Height : 90~200cm (±1mm), Weight : 2~250kg
0kg Adjustment		Auto 0kg Calibration during 3~15 Seconds of Warming up
Measurement Mode		WH (Weight & Height), W (Weight Only), H (Height Only)
Height measurement		Auto (Automatic System after Weight Measurement) NA (Press 'ENTER' Button after Weight Measurement Manually)
Weight Offset		0.0 ~ 5.0kg, Adjustment by 0.1kg
Operation Environment		10℃ ~ 40℃, 30~75% RH, 70~106kPa
Measurement Duration		Weight & Height : About 7 second, Weight Only : 2 second, Height Only : 5 second
External interface		RS-232C 1EA
Dimension & Weight		w380 × d510 × h1350 ~ 2126mm, 15.5kg
Power (Adapter)		Input : AC 100 ~ 240V, 50 / 60Hz, 1.2 A, Output : DC 12 V, 3.33 A
Cat. No.		DM.12.1008
Price, Each. ₩		918,390

Optional Accessory

DM.12.1009 Thermal Printer, for Height · Weight · BMI Result

Ea.	Price, ₩
	199,650

NEW



InBody® Basic Stadiometer “BSM270”, with Integrated Head Bar, 90~200cm, 10~200kg **NEW**
 With Pediatric Measurement Mode, Measure Height · Weight · BMI, 신장/체중/체지방 측정기, 소아측정모드 제공

- **Made in Korea**
- 압박감이 거의 없는 일체형 헤드바 사용으로 편안하고 정확한 기본형 자동신장체중계
- 헤드바를 160cm로 낮추어 측정시간 단축하고 정확도를 한층 높인 소아 측정모드 제공
- * 3 Measurement Modes for Examinee and Manager ;
 - Normal mode : the Examinee Checks the Measured Values in Place
 - Manager (Turn) Mode: the Display is Inverted for the Manager to Check the Measured Values
 - Auto Mode : the Display Reverses Automatically When the Examinee Step off the Instrument after Checking the Value

Specifications & Ordering information <M6>

Spec.	Model	“BSM270”
Measuring Range		Height : 90~200cm (±1mm), Weight : 10~200kg
0kg Adjustment		Auto 0kg Calibration during 3~15 Seconds of Warming up
Measurement Mode		WH (Weight & Height), W (Weight Only), H (Height Only)
Height measurement		Auto (Automatic System after Weight Measurement) Manual (Press 'ENTER' Button after Weight Measurement Manually)
Weight Offset		+5.0 ~ -5.0kg, Adjustment by 0.1kg
Operation Environment		10℃ ~40℃, 30~75% RH, 70~106kPa
Measurement Duration		Weight & Height : About 10 Second, Weight Only : 4 second, Height Only : 7 second
Dimension & Weight		w355 × d455 × h2170mm, 14kg
Power (Adapter)		Input : AC 100 ~ 240V, 50 / 60Hz, 1.2 A, Output : DC 12 V, 3.33 A / 3.0 A
Cat. No.		DM.12.1010
Price, Each. ₩		811,910

※ Manager Mode 에서는 Display가 반전됨

InBody® Portable Extensometer for Growth Management “InLabS50”, 50.0~200.0cm ±0.5cm, Measuring Time 1sec NEW
 Used with Growth and Development Management Apps “InKids”, LCD Display, <Korea-made>, 휴대용 신장계, 성장관리 어플지원



Display

- Made in Korea ■ 제품 하단부에 위치한 초음파센서를 통해 단 1초 만에 신장 측정이 가능
- Google Play Store 또는 App Store에서 InKids 앱을 다운로드 받아서 성장관리 가능
- 대기온도센서를 통해 실내의 온도 및 습도 측정 가능
- * Fast and Easy Height Measurement

Specifications & Ordering information

<M6>

Spec.	Model	“InLabS50”
Measure		Height, Room Temperature, Humidity
Measuring Range		Height : 50.0~200.0cm (±0.5cm), Room Temperature : 16°C~40°C (±1°C), Humidity : 30~80% (±7%)
Measuring Time		1 second (up to 7 second)
Sensor		Ultrasonic · Temperature · Humidity Sensor
Operating environment		16°C~40°C, 30~80% RH
Color		Green, Pink, Blue
Dimension & Weight		w43×d44×h300mm, 238g
Current Consumption		100mA or less
Power Consumption		DC 3V (1.5V AAA battery 4EA)
Cat. No.		DM.12.1011
Price, Each. ₩		102,490

Kern® [d] 1mm, L10~80cm Portable Baby Height Measuring Rod/Ruler NEW
 Ideal for Medical Diagnostics, with Large Guide Surfaces, 눈금이동형 아기용 신장계



L10 ~ 80cm

- Supplied by Kern® in Germany
- * Can be Used in Both Direction; Measuring Scale Start with 0 at Right and Left
- * Easy Handling with Large Guide Surfaces; Aligning / Shifting / Reading
- * Height Rod can be taken apart for Compact Storage
- * Measuring Range : L10~80cm and 1mm Division
- * Overall Dimension : Max. 890×330×h100mm

<M1>

KE.MSB.80 Height Rod, Measuring Range L10~80cm, Divi. 1mm, 700g

Ea.	Price, ₩
	154,980



L30 ~ 80cm

Kern® [d] 1mm, L30~80cm Portable Baby Height Measuring Rod/Ruler, Ideal for Medical Diagnostics With Readability on Scale with Moveable Stop, Robust and Compact Size, 길이조절형 아기용 신장계 NEW

- Supplied by Kern® in Germany
- * Suitable for Easy and Hygienic Cleaning
- * Easy Handling with Large Guide Surfaces; Aligning / Shifting / Reading
- * Readability on Scale with Moveable Stop
- * Measuring Range : L30~80cm and 1mm Division
- * Overall Dimension : Max. 850×240×h60mm

<M1>

KE.MBA.A01 Height Rod, Measuring Range L30~80cm, Divi. 1mm, 800g

Ea.	Price, ₩
	213,100



Kern® [d] 1mm, max.2.05m Circumference Measuring Ruler/Tape NEW
 Ideal for Medical Diagnostics, with Continuous Pull-out Mechanism, 신체부위 둘레측정 줄자

- Supplied by Kern® in Germany
- * Useful Diagnosis Instrument
- * with Integrated Feed Mechanism
- * Measure Length : 2,050mm and 1mm Division
- * Ideal to Determine the WHR(Waist to Hip Ratio); Suitable for Evaluating the Distribution of the Body's Fat Deposits

<M1>

KE.MSW200.S05 Measuring Tape, Circumference-type, 50g, L2.050m/Divi. 1mm

Ea.	Price, ₩	Cs.	Price, ₩
	12,600	5ea	58,240

Articles	Cat. No	Description
----------	---------	-------------

Kern® [d] 10g, max.15kg Ergonomically-Optimised Baby Scale, Ideal for Private NEW
 With Auto-off · Feeding · Hold · Memory-Function, Weight Displayed in kg or lb, 인기 보급형 신생아 체중계



2-Year Warranty

NEW



(1) Baby Scale



(2) Optional ; Carrying Case

- Supplied by Kern® in Germany ■ 2-Years Warranty ■ CE & ISO 9001 Certified
- Using the Scales in Medicine is not Allowed.
- Particularly Flat and Lightweight Construction, So it is Easy to Transport and Store.
- * Large, Ergonomically-Optimised Lying Surface for Safe Weighing of Infants ; 650×350×h55mm
- * Robust Plastic for Easy and Hygienic Cleaning.
- * Integrated AUTO-OFF Function to Preserve Batteries
- * Feeding Function ; Difference Function for Calculating the Weight Gain before and after Feeding
- * Hold Function ; When Patients do not lie completely still, a Stable Weight is Calculated Using an Average Weight
- * With Rubber Feet for Secure & Non-Slip Positioning
- * Batteries included (2×1.5V AAA), Operating Time up to 20h.

Specifications & Ordering information

<M1>

Cat. No.	Weighing Range Max kg	Readability d kg	Dimensions (W×D×H) & Weight	Price, ₩
(1) KE.MBD.20K2S05	15	0.01	650×350×55 mm, 2kg	147,220

Ea.	Price, ₩
(2) KE.YTB.01S05	11,630

(2) KE.YTB.01S05 Optional ; Carrying Case with Handle and Shoulder Strap

Kern® [d] 2/5 & 10g, max.6/15 & 20kg Elegantly-Precision Baby Scale, Medicaluse approved in Germany NEW
 Ideal for Weighing Neonates in Paediatrics, with Feeding-& Hold-Function, 정밀형 신생아 체중계



2-Year Warranty

NEW



Medicaluse

(1), (2) Baby Scale



(3) Height Rod

※ Figure ; Optional Height Rod Installed



(4) Optional Carrying Case

- Supplied by Kern® in Germany ■ 2-Years Warranty ■ CE & ISO 9001 Certified
- Verification Class III (Verification is Optional) ■ ISO 13485 Certified
- Approval for Medical Use According to 93/42/EEC
- Ideally Suited for Weighing Neonates in Paediatrics
- * Robust ABS Plastic for Easy and Hygienic Cleaning
- * Feeding Function ; Difference Function for Calculating the Weight Gain before and after Feeding
- * Hold Function ; When Patients do not lie completely still, a Stable Weight is Calculated Using an Average Weight
- * Baby Weighing Pan ; 600×280×h55mm
- * Rubber Feet for Secure & non-Slip Positioning
- * Protective Working Cover
- * Batteries Included (6×1.5V AA)

Specifications & Ordering information

<M1>

Cat. No.	Weighing Range Max kg	Readability d kg	Verif. Value e kg	Dimensions (W×D×H) & Weight	Price, ₩
(1) KE.MBC.15K2DEM	6 / 15	0.002 / 0.005	0.002 / 0.005	600×407×120 mm, 5.5 kg	513,340
(2) KE.MBC.20K10M	20	0.01	0.01		552,070

Ea.	Price, ₩
(3) KE.MBC.A01	213,100
(4) KE.MBC.A02	96,870

(3) KE.MBC.A01 Optional ; Mechanical Height Rod, L80cm, 1mm Division
 (4) KE.MBC.A02 ; Carrying Case, Only for Model without Height Rod

NEW



[d] 0.1kg, max.180 & 250kg

Kern® [d] 0.1kg, max.180 & 250kg Popular Maximum Body Scale, with Large LCD Display With Large · Flat Glass Weighing Plate, Ideal for Healthcare & Homecare, 가정용 스텝온 체중계 **NEW**

- Supplied by Kern® in Germany
- 2-Years Warranty
- CE & ISO 9001 Certified
- Large LCD Display and High-Contrast Display that is Easy to Read, Digit Height 40 & 50mm ; kg or lb
- Secure and Non-slip Positioning with Height-Adjustable Rubber Feet, Particularly Flat Design Facilitates Access
- * with Large · Flat · Sturdy Glass Weighing Plate
- * Easy and Hygienic Cleaning
- * Generous Weighing Capacity
- * Easy to Use and Time Efficient : Simply Tap on it, Stand on it, Read the Weight, Integrated AUTO-OFF Function
- * Battery Included, "MGD-100K-1" : 2ea×CR2032, "MGD-200K1L" : 3ea×1.5V AAA, Operating Time up to 100h

Specifications & Ordering information

<M1>

Cat. No.	Weighing -Range Max kg	Readability d kg	Weighing Plate Dimensions (W×D×H) & Weight	Price, ₩
KE.MGD.100K.1S05	180	0.1	300×300×19mm, 1.5kg	38,360
KE.MGD.200K.1LS05	250	0.1	380×330×27mm, 2kg	57,750

NEW

Medicaluse

(1) "AC/DC겸용" with Backlight

[d] 0.1kg, max.250kg



Medicaluse

(2) "DC용"

[d] 0.2kg, max.250kg



Step-on Function

Kern® [d] 0.1 & 0.2kg, max.250kg Step-on Floor Body Scale, Medicaluse approved in Germany With Large Display, Ergonomically Optimized Design, 의료용 스텝온 체중계 **NEW**

- Supplied by Kern® in Germany
- 2-Years Warranty
- CE & ISO 9001 Certified
- Approved as Medical Device according to 93/42/EEC
- ISO 13485 Certified
- * Easy to Use and Time Efficient : Simply Tap on it, Stand on it, Read the Weight.
- * Secure and Non-slip Positioning with Height-Adjustable Rubber Feet.
- * Large Platform with Non-Slip and Wear-Resistant Surface
- * Suitable for Easy and Hygienic Cleaning
- * Level Indicator Make to Level the Balance Precisely
- * Robust and Ergonomically Optimized Design
- * Dimensions of Display : 200×130×h60mm



(1) AC/DC겸용 with Backlight "MPD-M"

- Large Backlight LCD Display, Digit Height 25mm
- Mains Adapter External, Standard
- Battery Operation Possible, 6ea×1.5V AA, Not Included, Operating Time up to 20h

(2) DC용 "MPD-EM"

- Large LCD Display without Backlight, Digit Height 25mm
- Battery Operation, 6ea×1.5V AA, Included, Operating Time up to 20h

Specifications & Ordering information

<M1>

Cat. No.	Weighing -Range Max kg	Readability d kg	Verif. Value e kg	Weighing Plate Dimensions (W×D×H) & Weight	Price, ₩
(1) KE.MPD.250K.100M	250	0.1	0.1	365×360×80mm, 10 kg	561,750
(2) KE.MPD.200K.1EM	250	0.2	0.2		532,700

Articles	Cat. No	Description
----------	---------	-------------

NEW



① Individual Package



② 100pads ③ 200pads

MediTop® Disposable Ethanol Swab, for Skin Disinfection, 30×30 & 40×40mm, Medicaluse With 78.85% Ethyl Alcohol, 일회용 에탄올 스왑, 멸균/비멸균 소독솜 **NEW**

- Made in Korea ■ Made of Rayon Staple Fiber
- Made of Rayon Staple Fiber Containing 78.85% Ethanol Alcohol
- Ideal for Disinfection of Wound & Medical Equipment

* Easier and more Comfortable to Use for Disinfection
 * Easy to Carry * No Skin Irritation
 * for External Use Only * Approx Size Swab : 30×30 & 40×40mm

(1) Sterile, 78.85% Ethanol Swab

<M3>

Pk.	Price, ₩	Cs.	Price, ₩	
DM.13.1003	① Ethanol Swab, Sterile, Individual Package, 30×30mm	100pads	2,240	60pk
DM.13.1004	② , 100pads/Package, 40×40mm	100pads	1,210	100pk

(2) Non-Sterile, 78.85% Ethanol Swab

Pk.	Price, ₩	Cs.	Price, ₩	
DM.13.1005	① Ethanol Swab, Non-Sterile, Individual Package, 30×30mm	100pads	2,070	60pk
DM.13.1006	② , 100pads/Package, 40×40mm	100pads	1,040	100pk
DM.13.1007	③ , 200pads/Package, 40×40mm	200pads	1,390	48pk

NEW



Individual Package

MediTop® Disposable Isopropanol Swab, for Skin Disinfection, 30×30mm, Medicaluse With 70% Isopropyl Alcohol, Rayon Staple Fiber, 일회용 이소프로판올 스왑, 살균소독용 **NEW**

- Made in Korea ■ Made of Rayon Staple Fiber Containing 70% Isopropyl Alcohol

* Ideal for Disinfection of Wound & Medical Equipment
 * Easier and more Comfortable to Use for Disinfection
 * Easy to Carry * No Skin Irritation * for External Use Only
 * Approx Size Swab : 30×30mm

<M3>

DM.13.1008 Isopropanol Swab, 30×30mm, Individual Package

Pk.	Price, ₩	Cs.	Price, ₩	
DM.13.1008	Isopropanol Swab, 30×30mm, Individual Package	100pads	2,250	60pk

NEW



(1) 78.85% Ethanol

NEW



(2) 70% Isopropanol (3) 3% Hydrogen Peroxide

MediTop® Antiseptic Solution, Ethanol & Isopropanol & Hydrogen Peroxide, 250~4,000ml, Medicaluse Ideal for Disinfection of Skin, Affected Areas and Medical Device, 소독용 용액 **NEW**

- 피부 및 손의 소독 / 수술부위 피부의 소독 / 의료기구의 소독 ■ Made in Korea

(1) 78.85% Ethanol, 에탄올

<M3>

* Ideal for Disinfection of Skin, Hands, Surgical Sites and Medical Device

DM.	Description	Ea.	Price, ₩
DM.13.1009	Ethanol, 78.85%, 250ml		1,300
DM.13.1010	, 1,000ml		3,820
DM.13.1011	, 4,000ml		13,340

(2) 70% Isopropanol, 이소프로판올

* Ideal for Sterilization of Skin, Hands and Medical Device

DM.	Description	Ea.	Price, ₩
DM.13.1012	Isopropanol, 70%, 1,000ml		4,690
DM.13.1013	, 4,000ml		13,680

(3) 3% Hydrogen Peroxide, 과산화수소수

* Ideal for Disinfection of Wound, Mouthwash, Deodorization

DM.	Description	Ea.	Price, ₩
DM.13.1014	Hydrogen Peroxide, 3%, 250ml		880
DM.13.1015	, 4,000ml		4,690

3M® Steri-Strip™ Medical/Reinforced Skin Closure, Hypoallergenic Adhesive, Wound Support, w6/12 × L100mm, Medicaluse
Sterile, Breathable, Comfortable to Wear, Non-Invasive Design, **병원용 멸균 피부봉합 반창고** **NEW**



- 필라멘트가 들어가 있어 강한 장력을 제공; 흉터형성이 적음, 착용감 편함
- **Ideal for Surgical Lacerations and the Closure of Lacerations**
- **A Sterile, Breathable Adhesive Strip Reinforced with Polymer Filaments, for Strong, Reliable Closure of Incisions and Skin Lacerations.**
- * Easy to Apply * Allows Early Staple or Suture Removal
- * Provides Wound Support
- * Increases the Tensile Strength of the Wound, Compared to Sutures
- * Non-invasive & Sterile Design Reduces Scarring and the Risk for Infection



<M4>

3M.07.1546 Steri-Strip, Reinforced Skin Closure, w6mm × L100mm
3M.07.1547 , w12mm × L100mm

Pk.	Price, ₩	Cs.	Price, ₩
50ea	72,880	4pk	282,770
50ea	72,880	4pk	282,770

3M® Tegaderm™ Medical/Transparent Film Dressing/Bandage, Frame Style, Easy Monitoring of Wounds, Medicaluse **NEW**
Hypoallergenic, Waterproof, Versatility, **병원용 투명 방수 필름 드레싱/밴디지**



- 투명하여 Wound와 IV Site 관찰 용이, 고정력 우수, 부드러운 점착, 독특한 Frame Style로 드레싱 부착, 편의성 우수.
- **3M™ Tegaderm™ Transparent Film Dressings can be used to cover and protect catheter sites and wounds, to maintain a moist environment for wound healing and to secure devices to the skin.**
- **Ideal for Securing Tubing and devices, Improving Patient Comfort, and Minimizing Trauma to Tender Catheter Sites.**
- * Provides a Waterproof, Sterile Barrier to External Contaminants including Liquids, Bacteria and Viruses
- * Easy to Cut to any Shape and Size
- * IV catheter and percutaneous devices securement

<M4>

3M.07.1622W I.V. Film Dressing / Bandage, Clear, 4.4cm × 4.4cm
3M.07.1624W , 6cm × 7cm
3M.07.1626W , 10cm × 12cm

Pk.	Price, ₩	Cs.	Price, ₩
100ea	26,140	4pk	101,380
100ea	31,630	4pk	122,710
50ea	27,510	4pk	106,710

3M® Tegaderm™ I.V. Advanced Securement Dressing/Bandage, Frame-Style, Sterile Tape Strips, Reinforced Border, Medicaluse
For IV Catheter and Percutaneous Devices Securement, **병원용 I.V. 어드밴스드 투명 필름 드레싱/밴디지, 통기성향상+정맥주사 고정용** **NEW**



- 정맥주사 고정, 우수한 통기성, 삽입부위 관찰 용이, 투명성, 액체와 세균으로부터 주사 부위 보호
- **A Line of I.V. Dressings which Optimizes All Characteristics to Provide Advanced I.V. and Central Line Catheter Securement.**
- * Easy to Apply and Remove Gently * Provided up to 7 Days of Wear Time for CVC's
- * Securing Tubing, Devices, and Arterial Catheters
- * Maintain Securement by Preventing Edge Lift and Flexing with Patient Movement
- * Sterile Barrier to External Contaminants including Liquids, Bacteria and Viruses
- * Picture-Frame Delivery Provides Maximum Control of Application without Touching Dressing Adhesive



<M4>

3M.07.1683 I.V. Advanced Film Dressing / Bandage, Clear, 6cm × 7cm

Pk.	Price, ₩	Cs.	Price, ₩
100ea	45,380	4pk	176,060

3M® Medical/Eye Patch, Using for Amblyopia or Squint Treatment, Medicaluse **NEW**



Hypoallergenic & Latex Free, Highly Breathable, Re-Stickable, Gentle to Skin
병원용/아이패치, 약시나 사시의 가림치료용 패치 드레싱

- **약시나 사시의 가림치료를 위한 저자극성 아이패치 드레싱; (1) PREMIUM & (2) 표준급**
- * Easily applied & Removed with Minimal Skin Irritation
- * Gentle to Skin
- * Comfortable to Wear
- * Sticks well and Removes Easily

<M4>

(1) PREMIUM Silicone Soft Eye Patch, 프리미엄 실리콘 소프트 아이패치
3M.07.2733 Eye Patch, Premium, Silicone, 63 × 49mm

Pk.	Price, ₩	Cs.	Price, ₩
14ea	12,100	20pk	234,740

(2) Tegaderm™ Standard Eye Patch, 테가덤™ 표준 아이패치
3M.07.1733 Eye Patch, Standard, 63 × 47mm

Pk.	Price, ₩	Cs.	Price, ₩
20ea	3,720	36pk	129,660

Articles

Cat. No

Description

3M® Micropore S™ Surgical Silicone Tape, for General Securement & Gentle Wear to Skin, w2.5cm, L1.3m Roll, *Medicaluse* NEW
Breathable, Hypoallergenic, Skin Performance, Sky Blue, **병원용 실리콘 의료 테이프/반창고**



- 피부자극이 적은 하늘색 격자 실리콘 점착 반창고; 부드럽게 고정, 안전한 제거
- **Ideal for Sensitive & Fragile Skin and Securing Dressing / I.V. Catheter / Tubing & Devices**
- * Offers Reliable and Pliable Fixation(48hours)
- * Removes Cleanly without Disrupting Fragile Skin Layers or Causing Patients Undue Pain
- * Easy to Use ; Can be Repositioned and Neatly Torn by Hand

3M.07.2770.0 Micropore S™ Silicone Tape, Sky Blue, 2.5cm × 1.3m roll

Pk.	Price, ₩	Cs.	Price, ₩
100 roll	247,510	5pk	1,200,390

<M4>

3M® Durapore™ Surgical Silky Hypoallergenic Tape, White, Hi-Strength, Versatile, w1.25~5cm, L9.14m Roll, *Medicaluse* NEW
Water Resistance, Conformable, **병원용 써지칼 실키 반창고, 백색, 우수한 내구성**



- 점착력이 우수한 실크 느낌의 흰색 반창고; 내구성 우수, 양방향으로 찢어짐, 건조 피부에 적합
- **Ideal for Securing Tubing / Devices / I.V. Catheter, Anchoring Bulky Dressings, Immobilizing Finger & Toe and Stabilizing Finger Splints**
- * Adheres well to Dry Skin ; High Strength / Versatile / Conformable
- * Convenient Bidirectional Tear, Hypoallergenic

3M.07.1538.0 Durapore™ Silk-like Tape, White, 1.25cm × 9.14m roll
3M.07.1538.1 , 2.5cm × 9.14m roll
3M.07.1538.2 , 5cm × 9.14m roll

Pk.	Price, ₩	Cs.	Price, ₩
24 roll	18,580	10pk	180,070
12 roll	18,580	10pk	180,070
6 roll	18,580	10pk	180,070

<M4>

3M® Transpore™ Surgical Tape, Clear, Porous, Plastic Hypoallergenic, w1.27~5.08cm, L9.14m Roll, *Medicaluse* NEW
Water Resistance, Good Initial & Long-term Adhesion, **외과용 투명 필름/반창고, 적용 부위 관찰 용이, 찢기 편리**



- 격자 무늬가 있어서 양방향으로 찢기 편리한 투명 필름 반창고; 점착력 우수, 적용 부위 관찰 용이
- **Ideal for Anchoring Bulky Dressing and Securing I.V. Catheter / Tubing & Devices**
- * Easy / Straight / Bi-Directional Tear, Easy to Handle with Glove, Transparent, Porous
- * Good Adhesion to Skin and Tubing * Easy to Customized Tape Width
- * Hypoallergenic and Not Made with Natural Rubber Latex

3M.07.1527.0 Transpore™ Surgical Acryl Tape, 1.27cm × 9.14m roll
3M.07.1527.1 , 2.54cm × 9.14m roll
3M.07.1527.2 , 5.08cm × 9.14m roll

Pk.	Price, ₩	Cs.	Price, ₩
24 roll	16,510	10pk	160,060
12 roll	16,510	10pk	160,060
6 roll	16,510	10pk	160,060

<M4>

3M® Micropore™ Surgical Paper Tape, White, Hi-Breathable, Hypoallergenic, w1.27~5.08cm, L9.14m Roll, *Medicaluse* NEW
Taping at Fragile & Risk Skin, **병원용 가장 범용 의료 종이 반창고, 저자극성/통기성**



- 병원에서 가장 범용적으로 사용되는 저자극, 저알러지성, 반복테이핑에 적합
- **Ideal for Securing Small to Medium Dressings / Lightweight Tubing / I.V. Catheter and Repeated Taping**
- * Gentle Adhesion, Conformable and Highly Breathable
- * Reliably Secures Dressings and Devices to Skin
- * Convenient Bidirectional Tear, Hypoallergenic

3M.07.1530.0 Micropore™ Surgical Paper Tape, White, 1.27cm × 9.14m roll
3M.07.1530.1 , 2.54cm × 9.14m roll
3M.07.1530.2 , 5.08cm × 9.14m roll

Pk.	Price, ₩	Cs.	Price, ₩
24 roll	11,430	10pk	110,710
12 roll	11,430	10pk	110,710
6 roll	11,430	10pk	110,710

<M4>

3M® Medical/Soft Cloth Tape with Liner, for Critical Securement & Gentle on Skin, w5~15cm × L10m Roll, *Medicaluse* NEW
Good Adhesion, High Breathable, Hypoallergenic, **의료용 부드러운 천 반창고/테이프**



- 통기성과 점착력이 우수; 굴곡진 신체 부위에도 잘 밀착됨
- **Ideal for Anchoring Post-surgical Dressings, Securing Tubing / Devices / Catheters, and Minimizing the Risk for Skin Injury**
- * Adhered to the Bending Body Part Well * Soft Cloth Material to Maintain Skin Integrity
- * Easy to Cut to a Desired Size
- * Excellent Cross and Diagonal Stretch to Accommodate Movement or Swelling
- * Wave Patterned Adhesive Coating for Better Breathability and Patient Comfort
- * Suitable for Using on Surgical Sites & Areas where Skin May Stretch

3M.07.2762 Soft Cloth Tape, 5cm × 10m roll
3M.07.2763 , 7.5cm × 10m roll
3M.07.2764 , 10cm × 10m roll
3M.07.2766 , 15cm × 10m roll

Roll.	Price, ₩	Cs.	Price, ₩
4,000		36roll	139,250
6,050		24roll	140,850
7,990		18roll	139,250
11,020		12roll	128,050

<M4>

3M® Coban™ Medical/Self-Adherent Wrap, Immobilizing Injuries & Provide Compression, w2.5 & 15cm, L4.5m Roll, **Medicaluse**
 Used to Secure Dressing, Sticks to itself, Porous, Comfortable, Lightweight, **의료 압박용 밴드 NEW**



- 별도의 반창고나 고정 장치 없이도 자가점착되어 사용이 편리함; 가볍고 편안한 착용감
- **Ideal for Compression Dressing, Reducing Post-operative Swelling, and Fixing Limbs for Splints and Arm Board**
- * Sticks to Itself without the Need for Adhesive, Pins or Clips
- * Wrap Stays in Place; No need for Frequent Adjustment
- * Easy to Use; Not sticking to Skin, Hair, Clothing or Drapes
- * Used to Secure and Protect Primary Dressings and Other Devices
- * Soft, Comfortable, Porous, Breathable, Lightweight, and Convenient
- * Slip-minimizing Cohesion is Good for Active Patients

3M.07.1581	Coban™ Self-Adherent Wrap, 25mm × 4.5m roll
3M.07.1582	, 50mm × 4.5m roll
3M.07.1583	, 75mm × 4.5m roll
3M.07.1584	, 100mm × 4.5m roll
3M.07.1586	, 150mm × 4.5m roll

Roll. Price, ₩		Cs. Price, ₩	
	1,860	30roll	49,890
	2,900	36roll	93,370
	4,030	24roll	86,700
	5,380	18roll	86,700
	8,050	12roll	86,700

<M4>

Moalab® Sequential Adhesive Spot Bandage, Roll of 100 Sterile Injection Care Band(φ 20 & φ 35mm), **Medicaluse** **NEW**
 Ideal for Medicine Injection & Blood Collection, Made of Natural Cellulose, Hemostatic, Sterilized by γ-Radiation, **원형 롤 밴드, 주사/채혈용, 멸균**



- **Made in Korea** ■ **채혈, 수혈, 약물, 백신주사 등 침 시술 부위의 상처를 보호 및 지혈, 2차 감염 예방하는 1회용 밴드**
- * Prevention of Contamination and Infection Caused by Bleeding
- * Convenient Pop-up Type
- * Kids Friendly Print to Distract and Reduce Anxiety (for Kids)
- * Minimize Skin Allergies

1. For Injection & Vaccination, φ 20mm, 주사 & 백신용, 멸균

DM.13.1045	(1) Sequential Spot Bandage, Injection, φ 20mm, Beige
DM.13.1046	(2) , Beige Kids
DM.13.1047	(3) , White Kids

Pk.	Price, ₩	Cs.	Price, ₩
100ea	2,730	20pk	54,450
100ea	2,730	20pk	54,450
100ea	2,730	20pk	54,450

<M4>

2. For Blood Collection, φ 35mm, 채혈용, 멸균

DM.13.1048	(4) Circular Adhesive Bandage, Blood Collection, φ 35mm, Beige
-------------------	--

Pk.	Price, ₩	Cs.	Price, ₩
200ea	12,100	10pk	121,000

Moalab® Sequential Adhesive Bandage, Roll of 36 Sterile Band Ventilation Type(75 × 20mm), **Medicaluse** **NEW**
 Ideal for First Aid, Woven Dressing Fabric, Hemostatic, Hypoallergenic, Hygienic, Sterilized by γ-Radiation, **일자형 롤 밴드, 상처보호용, 멸균**



- **Made in Korea** ■ **한장씩 뽑아쓰는 1회용 밴드, 상처 부위 보호기능 매우 우수**
- * Convenient Pop-up Type
- * With Long-lasting Adhesive
- * Minimize Skin Allergies
- * Kids Friendly Print to Distract and Reduce Anxiety (for Kids)

(1) Standard Type, 일반 밴드

DM.13.1049	Sequential Adhesive Bandage, w75 × L20mm, Beige
-------------------	---

Pk.	Price, ₩	Cs.	Price, ₩
36ea	2,730	12pk	32,670

<M4>

(2) For Kids, 아동용 캐릭터 밴드

DM.13.1050	Sequential Adhesive Bandage, w75 × L20mm, White, for Kids
-------------------	---

Pk.	Price, ₩	Cs.	Price, ₩
36ea	2,730	12pk	32,670

, -First Aid Bandage & Dressing 상처 보호 밴드



Yuhan® First-aid/Sterilized Adhesive Bandage, Standard Stick-type, 19 × 72mm, 20 & 40 Sheet
 With Acrylic Adhesives, Acrinol attached Fabric, Polyethylene Mesh, **일반용 멸균 밴드, 일반형 & 방수형 NEW**

- **Made in Korea** * Water-resistant Acrylic Adhesive
- * Cushion Pad : Fabric with Disinfectant(Acrinol)
- * Easy Removal due to Polyethylene Mesh on Cushion Pad
- * Polyvinyl Chloride Film (Normal-type) / Ultra-thin urethane Film (Waterproof-type)

Y2.513245	(1) Normal Sterilized Bandage, w19 × h72mm
Y2.513344	(2) Waterproof Sterilized Bandage, w25 × h72mm

Pk.	Price, ₩
40Sheet	1,920
20Sheet	3,580

<B4>

Articles	Cat. No	Description
----------	---------	-------------



(1) Ankle (2) Elbow



(3) Knee (4) Wrist



(5) Combined Wrist

Joint Supports, For Ankle · Elbow · Knee · Wrist, Help Limit Motion, Anatomical Shape, *Medicaluse* Comfortable & Breathable Design, 관절보호대, 뛰어난 신축성과 편안한 착용감 **NEW**

- **Made in Korea**
- 고급원사로 입체적 제작하여 빠른 땀흡수와 통기성으로 장시간 착용시에도 쾌적함 유지
- 착용부를 지지, 압박하고 고정시켜주어 무리한 운동이나 활동으로부터 근육을 보호
- * 보호 및 부상 예방을 위한 제품이지만 일상생활에서도 부담 없이 착용할 수 있는 제품
- * 부위별 짜임밀도가 다르게 제작되어 다른 압박감을 줌으로써 얇지만 효과적으로 근육압박
- * Designed for All day Comfort, Anatomical Shape for Optimal Fit & Joint Protection
- * Helps Provide Reliable Support to Weak or Injured Joint.
- * Thin, Light, and Three-dimensional Texture gives a Comfortable Fit
- * Due to the Different Texture Density of Each Part, Different Compressive Strengths are given to the Muscles. <M1>

Cat No.	Support	Size	Ea. Price, ₩
DM.07.1001	(1) Ankle	S, 22 ~ 24cm	8,470
DM.07.1002		M, 24 ~ 26cm	8,470
DM.07.1003		L, 26 ~ 28cm	8,470
DM.07.1004	(2) Elbow	S, 19 ~ 22cm	8,470
DM.07.1005		M, 22 ~ 25cm	8,470
DM.07.1006		L, 25 ~ 28cm	8,470
DM.07.1007	(3) Knee	S, 31 ~ 34cm	8,470
DM.07.1008		M, 34 ~ 37cm	8,470
DM.07.1009		L, 37 ~ 40cm	8,470
DM.07.1010	(4) Wrist	S, 13 ~ 15cm	8,470
DM.07.1011		M, 15 ~ 17cm	8,470
DM.07.1012		L, 17 ~ 19cm	8,470
DM.07.1013	(5) Combined Wrist	S, 13 ~ 15cm	8,470
DM.07.1014		M, 15~17cm	8,470
DM.07.1015		L, 17 ~ 19cm	8,470



Lumbar Support, with 4 High Elastic Support & Double Belt, *Medicaluse*, 기능성 허리 보호대 **NEW**

- **Made in Korea**
- 등쪽 4개의 고탄력 지지대와 이중벨트 적용으로 허리를 편안하고 안전하게 받쳐줌
- * 가볍고 얇은 스판덱스 소재를 사용하여 신축성과 통기성이 우수하고 편안함을 유지함
- * Light and Thin Spandex for Excellent Elasticity, Breathability and Comfort <M2>

Cat No.	Size	Ea. Price, ₩
DM.07.1016	M, 25 ~ 28 inch	28,800
DM.07.1017	L, 28 ~ 31 inch	28,800
DM.07.1018	XL, 31 ~ 35 inch	28,800

Premium Aluminum Lightweight Wheelchair, for the Elderly, the Disabled and Limited Pedestrians, 15kg, Medicaluse NEW
 With Height Adjustable Armrests, Backrest & Protective Brake, 고급형 휠체어, 팔걸이 높이 조절형, 보호용 브레이크 장착



- **Made of Aluminum; Lightweight, Durable**
- * Comfortable, Manoeuvrable and Stable
- * with Protective Brake for the Caregiver
- * Easy to Carry; Folding Backrest & Detachable Armrests, Footrest and Back Wheel
- * Approx. Wheels Size : Front Wheel (6inch : 15.24cm), Back Wheel (22inch : 55.88cm)
- * Approx. Seat Size : w420 × h470mm
- * Weight Capacity : 100kg

DM.12.1012 Wheelchair, Aluminum, 600 × 1,040 × h930mm, 15kg

<M2>	
Ea.	Price, ₩
	389,620

Aluminum Lightweight Wheelchair, for the Elderly, the Disabled and Limited Pedestrians, 12kg, Medicaluse NEW
 With Fixed Armrests, Backrest, 휠체어, 팔걸이 고정형, 컴팩트 타입, 일반형



- **Made of Aluminum; Lightweight, Durable**
- * Comfortable, Manoeuvrable and Stable
- * Easy to Carry; Folding to Compact Size : w320mm
- * Approx. Wheels Size : Front Wheel (6inch : 15.24cm), Back Wheel (22inch : 55.88cm)
- * Approx. Seat Size : w440 × h450mm
- * Weight Capacity : 100kg

DM.12.1013 Wheelchair, Aluminum, 620 × 950 × h880mm, 12kg

<M2>	
Ea.	Price, ₩
	228,690

Rollator(Wheelchair Rollator Walker), 2 in 1 Walker Aid & Transport Chair, Ideal for the Disabled or the Elderly, Medicaluse NEW
 Compact Folding, Weight Capacity 80/100kg, 보행보조차, 성인, 노인용



(1) With Armrest, Dual Brake-Handle and Anchor

- **거동이 불편한 사람의 보행을 보조, 보관이 편리한 접이식 구조, 휴대용 적재함**
- * Made of Aluminum & PVC Frame with EVA Castors
- * Safe and Durable Handle Brake
- * Under Seat Storage Bag, Load Capacity 10kg
- * Compact Folding System - Easy Storage in Car Trunk, Living room, and Corner
- * Set the Movement of the Front Wheels in 3 Way (0°/90°/360°) by Turning the Caster Switch Knob UP and DOWN
- * Prevent Car Accident Due to Reflective Tape for Night-time Use

(1) With Armrest, Dual Brake-Handle and Anchor, 팔걸이형

- * Lock the Rollator by Side Lock Anchor
- * Overall Dimension & Weight : w500 × d630 × h870 (Max. 940) mm, 6.2kg
- * Weight Capacity Max SWL (Single User Weight) : 80kg
- * Seat Size : w360 × d320 mm * Seat Height : 445 mm

DM.12.1014 Rollator, with Armrest, w500 × d630 × h870 mm, 6.2kg

<M2>	
Ea.	Price, ₩
	152,460



(2) Without Armrest and Handle Brake

(2) Without Armrest and Handle Brake

- * Overall Dimension & Weight : w540 × d430 × h840 (Max. 930) mm, 5kg
- * Weight Capacity Max SWL (Single User Weight) : 100kg
- * Seat Size : w360 × d310mm * Seat Height : 460mm

DM.12.1015 Rollator, without Armrest, w540 × d430 × h840mm, 5kg

Ea.	Price, ₩
	135,520

Articles

Cat. No

Description

NEW

Medicaluse



(1) Walker Type

NEW

Medicaluse



(2) Table Type

Walking Assistance Equipment, Walker & Table Type, **Medicaluse** NEW

Ideal for Helping the Elderly Walk, 보행 보조차, 재활 및 노인용

- 거동이 불편하신 분들의 보행을 보조해주는 맞춤형 제품
- 높이 조절 가능 (Walker Type)

- * Customized Products that Help People with Mobility Difficulties Walk
- * Convenient and Simple Folding Structure Makes it Easy for Anyone to Operate.
- * Elder People can Use it Indoors, Making it Easier for Them to Use it When Moving Around
- * Made Easy to Store in Less Space * Adjustable Height to Suit Your Needs

Specifications & Ordering Information

<M2>

Spec.	Model	(1) Walker Type	(2) Table Type
Pedestrian Max. load (kg)		100 kg	
Dimension		410×560×h730~900mm	620×640×h1000mm
Weight		2.5 kg	10 kg
Material		Aluminum & PVC	Stainless Steel & Artificial Leather
Cat. No.		DM.12.1016	DM.12.1017
Price, Each. ₩		52,520	160,930

NEW

Medicaluse



(1) Walker Type



(2) Table Type

Adjustable Walking Stick, with 1- & 4-Legged Type, **Medicaluse** NEW

Ideal for Helping the Elderly Walk, with Wrist Strap, 길이 조절가능 보행 보조 지팡이, 재활 및 노인용, 2단/다축형

- 거동이 불편하신 분들의 보행을 보조해주는 맞춤형 제품
- 10단계 높이 조절, 손목 스트랩 부착

- * Customized Products that Help People with Mobility Difficulties Walk
- * Convenient and Simple Height Adjustment Makes it Easy for Anyone to Operate
- * Made Easy to Store in Less Space * 10 Step Height Adjustment is Possible
- * Wrist Straps Attached to Help Ensure User Stability

Specifications & Ordering Information

<M2>

Spec.	Model	(1) Walker Type	(2) Table Type
Pedestrian Max. load (kg)		100 kg	
Adjustable Length		700~930mm	725~950mm
Weight		330 g	900 g
Material		Aluminum	Aluminum & EVA
Cat. No.		DM.12.1018	DM.12.1019
Price, Each. ₩		9,320	14,400

SMART Solution for Preventing Dementia, Kiosk- & Tablet-type, with Cognitive Assessment · Cognitive Therapies · Fun Games NEW
 For Rehabilitation Hospital and Public Health Center, 스마트 치매예방 키오스크 & 태블릿, 치매 자가진단/치료, 전문 예방 프로그램 탑재

NEW



A. Kiosk-type



B. Tablet-type

- 그룹인지훈련 시스템에 해당하는 검증된 콘텐츠를 개인적으로 사용 가능한 키오스크/태블릿
- CoSAS, MMSE-DS 검사도구 2가지, 40가지 인지훈련, 운동요법, 회상훈련, 이완요법 탑재
- * 게임으로 즐기는 치매예방 관리 * 훈련결과 Data 관리 가능
- * A Kiosk for Personal Use of Content Corresponding to the Group Cognitive Training System
- * 2 Test Tools (CoSAS, MMSE-DS), 40 Cognitive Trainings, Exercise, Recall and Relaxation Therapies
- * Equipped with a Proven Professional Prevention Program * Designed for Comfortable Use

- ▶ **“CoSAS” Cognitive Assessment System (Dementia Test), 인지평가/치매검사**
 - Cognitive Evaluation for the Elderly or Dementia Risk Group
 - Measures the Appropriate Individual Cognitive Ability by Judging Activation
- ▶ **“CoTras-Pro” Complex Cognitive Therapy System (40 Types), 복합 인지치료/인지재활**
 - Dementia Prevention, Cognitive Rehabilitation Training for Mild Cognitive Impairment
- ▶ **Fun Games (Multiplayer, 8 types), 다인용 게임 8종**
 - Easy and Fun Training for the Elderly or Mild Cognitive Impairment
 - Low Resistance to Cognitive Training and Efficient Therapy
 - Multiple People can be Trained with One Device.

A. Kiosk-type

<M5>

Spec.	Model	Kiosk-type 키오스크 타입
Display Size		32 inch
Touch Type		PCAP
Sound Output		Built-in Speaker
OS		Windows 10
CPU		Intel Core Processor i3-8100
Main Board		Intel Chipset H310
Memory		DDR4 8G PC4-2400
SSD		NVMe M.2 256G
Power Supply		19V/7.9A or more
Input Device		Keyboard, Mouse (Wire-type)
Dimensions (mm)		w878×h1105×d650 mm
Cat. No.		DM.12.1020
Price, Each. ₩		9,100,000

B. Tablet-type

Spec.	Model	Tablet-type 태블릿 타입
Model		Galaxy Tap A7 Wi-Fi [SM-T500NZAEEKOO]
CPU		Octa-Core, Speed : 2 GHz, 1.8 GHz
Display		Resolution(Main) : 2,000 × 1,200 (WUXGA+), TFT
Display Size		10 inch
Camera		Rear + Front Camera : Pixel 8.0 MP + 5.0 MP
External Memory Support		Micro SD (Maximum 1 TB)
RAM / ROM		3 GB / 64 GB
Dimensions (mm)		w247.6 × h157.4 mm, Thickness : 7 mm, Weight : 476 g
Cat. No.		DM.12.1021
Price, Each. ₩		2,500,000



키오스크 설치 사례



태블릿 설치 사례



게임 하나당 대략 3~10분 소요



훈련 결과

EXP 산업용 팬 히터, Industrial Electric Fan Heater for 20m² & 30m² area 다국적 생산물배상책임보험 3억원 보험가입



■ Adjustable Temperature, Blowing Air Angle, High Function, and High Economics

▶ EFH-2000



- 본체 각도조절 기능으로 다양한 작업 환경 제공
- PTC히팅 방식으로 환기가 필요없음
- 저소음, 고에너지의 효율성
- 산화가스 발생이 없는 친환경 제품
- 자동 설정 온도 센서로 일정한 온도 유지
- 국문 설명서 동봉으로 손쉬운 사용 및 유지가능

EFH-2000

- 전압 : 220V / 60Hz
- 전력 : 2kW
- 출력 : 25 / 1000 / 2000W
- 발열량 : 1,720Kcal/h
- 사용면적 : 20m²
- 중량 : 2.0kg
- 소음 : 51dB

EFH-3000

- 전압 : 220V / 60Hz
- 전력 : 3kW
- 출력 : 25 / 2000 / 3000W
- 발열량 : 2,580Kcal/h
- 사용면적 : 30m²
- 중량 : 2.4kg
- 소음 : 54dB

ORDER NO.	MODEL NO.	PRICE, ₩	최대전력(kW)
▶ 0486-586	EFH-2000	44,110	2
0486-588	EFH-3000	70,560	3

SG 산업용 세라코울 히터
Cerak Wool Heater KOREA



- 저전력 고효율 (소비전력 대비 2배 발열효과)
- 즉각 발열 ■ 코드선 부착형

SGN-100

340×245×h560mm

▶ SGN-100 / SGN-200

SGN-200

490×280×h580mm

<B3>

ORDER NO.	MODEL NO.	PRICE, ₩	소비전력(kW)	온도조절
▶ 0440-183	SGN-100	117,600	1.7	약
▶ 0440-185	SGN-200	147,000	2.8	강/약

SG 산업용 카본 전기 온풍기
Carbon Electric Heater KOREA



- 리모컨 조작
- 이동바퀴
- 강·약 온도 조절

▶ DWJ-3000S

<B3>

ORDER NO.	MODEL NO.	PRICE, ₩	소비전력 (kW)	규격 (mm)	
				W×D×H	핀수
▶ 0494-595	DWJ-3000S	443,950	3.2	600×260×850	11
0494-596	DWJ-5000S	464,520	4.5	600×260×850	15

SG 다용도 전기 라디에이터
Electric Radiator Heater KOREA



■ Wide Range / Economics

- 24시간 타이머부착 ■ 이동용 바퀴 부착
- 전도안전 스위치 ■ 3단계 온도조절 기능

▶ SGR-05T

<B3>

ORDER NO.	MODEL NO.	PRICE, ₩	소비전력 (kW)	규격 (mm) W×D×H	핀수
▶ 0352-977	SGR-05T	53,230	1.0	320×140×700	5
0353-409	SGR-07T	60,760	1.5	320×140×700	7
0353-426	SGR-09T	68,020	2.0	470×140×700	9



▶ SGR-11T

<B3>

ORDER NO.	MODEL NO.	PRICE, ₩	소비전력 (kW)	규격 (mm) W×D×H	핀수
▶ 0353-410	SGR-11T	77,230	2.5	550×140×700	11
0353-412	SGR-13T	86,240	2.5	630×140×700	13
0353-427	SGR-15T	97,710	3.0	710×160×700	15

SG 다용도 전기 온풍기
Multiuse Electric Heater KOREA



■ 다방면 사용처; 사무실/영업장/산업현장, 기타

- 리모컨 조작
- 이동바퀴, 송풍기능
- 예약 타이머, 강·약 온도 조절

<B3>

ORDER NO.	MODEL NO.	PRICE, ₩	소비전력 (kW)	규격 (mm) W×D×H
0494-609	SGN-30	176,400	2.8	437×375×755

SG 온풍 세라믹 전기히터, 소형·강력
Compact Ceramic Heater KOREA



■ 사용처; 가정/업소/사무실

- 360도 송풍과 2배의 난방효과
- 반사판 부착
- 강, 약 온도 조절
- 온풍가능
- 전도안전 스위치

▶ SEM-350A

<B3>

ORDER NO.	MODEL NO.	PRICE, ₩	소비전력 (kW)	규격 (mm) W×D×H
▶ 0292-295	SEM-350A	76,440	Max 3.0	350×350×650

부탄가스 히터, 간편소형, Butane Gas Heater, Compact-type, 25.5×23×h24.5cm, 1.4kg TAIWAN

■ 사용연료: 시장(Market)에 유통되는 Ro Butane Gas Can (net 200g.) 1 Ea.



■ 파워센스 히터

- 사용연료 : 부탄 가스
- 원터치 압전자동점화방식
- 유로 차단식 가버너 장착으로 안전
- 열전도판 장착으로 가스의 기회력을 높임
- 가스 장착부가 개폐되어 있어 가스 장착, 해체가 용이함
- 이동 손잡이, 조절 손잡이 장착

	규격(mm)	중량(kg)
KGH-2006	255×227×245	1.4

<B3>

ORDER NO.	MODEL NO.	PRICE, ₩ Ea.	포장단위 Ea. / Cs.
0386-672	KGH-2006	107,800	1 / 4

전기 침적 히터, 물 가열용에 최적, Immersion Electric Heater, Ideal for Water Heating KOREA

- 물이 최저수위(200mm) 아래에 있으면 자동으로 전원이 차단
- 수동온도 조절기를 이용하면 적정온도 이내에서 자동차단 및 복구
- 히터 이상과열로 인한 과승발생 제어

⚠ 주의사항

- 과승제어 이후 전원코드를 반드시 콘센트로부터 분리 후 다시 꼽아야 전원투입
- 220V전용이며 누전차단기를 설치하여 사용



ORDER NO.	타입	PRICE, ₩	소비전력 (kW)	전장 (M)
0387-355		43,330	1.5	0.4
0387-356		48,220	1.5	0.7
0387-360	국자형	48,220	3	0.7
0387-362		59,400	3	1
0387-361		88,200	3	1.5

<B3>

히트템 핫 팩, 핸드워머 & 부착(파스)형, HEATTEM Hot Pack KOREA

NEW



① 레드(일반형)



② 그린(대형)



③ 파스형(부착형)

ORDER NO.	MODEL NO.	PRICE, ₩ Ea.	용량(g)	지속시간(h)	포장단위 Ea. / Pk.
① 0438-539	레드(일반형)	400	90	15	1 / 20
② 0438-538	그린(대형)	640	140	15	1 / 10

ORDER NO.	MODEL NO.	PRICE, ₩ Ea.	용량(g)	지속시간(h)	포장단위 Ea. / Pk.
③ 0438-540	파스형(부착형)	420	40	12	1 / 20
④ 0416-612	엄마발난로	400	20+20	8	1 / 10

<B3>

Articles	Cat. No	Description								
 <p>(1) "LH35" for Hard Specimen</p> <p>(2) "LS35" for Soft Specimen</p> <p>(3) "HS35", Wide Knife</p>	<p>MUTO® Microtome Disposable Blade, "Histo Cutter", Stainless-steel, for Soft & Hard tissue NEW</p> <p>With Excellent Polishing and Coating, Sharp & Durable, <Japan-made>, 일회용 조직절단용 칼</p> <ul style="list-style-type: none"> ■ Specimen의 원형을 유지하면서 특정 두께로 스크래치 없이 절단 ■ Sectioning the Specimens at Certain Stable Thickness ■ Maintain the Original Shape of Specimen <p>* The Paraffin Sections are Maintained almost Same Size of Blocks</p> <p>* Ideal for the Myoma of the Uterus, the Prostate, the Mammary Gland, the Thyroid Gland, the Bronchial Bones &c.</p> <p>* Easy Thin Sectioning with a Number of Paraffin Blocks without Scratches on the Specimens</p> <p>* Average Number of Block per a Blade with 3micron Sectioning</p> <p style="text-align: right;"><M3></p> <p>- 50~60 for Pathological Specimens - 35~40 for Anatomical Specimens</p> <p>DM.02.1001 (1) Stainless-steel Microtome Blade "LH35" for Hard Specimen (t) 0.25mm, 8×80mm, Edge Angle 35°</p> <p>DM.02.1002 (2) Stainless-steel Microtome Blade "LS35" for Soft Specimen (t) 0.25mm, 8×80mm, Edge Angle 35°</p> <p>DM.02.1003 (3) Stainless-steel Microtome Blade "HS35", Wide Knife (t) 0.32mm, 14×80mm, Edge Angle 35°</p>	<table border="1" style="width: 100%; border-collapse: collapse;"> <thead> <tr> <th style="width: 10%;">Pk.</th> <th style="width: 90%;">Price, ₩</th> </tr> </thead> <tbody> <tr> <td>50ea</td> <td>110,110</td> </tr> <tr> <td>50ea</td> <td>110,110</td> </tr> <tr> <td>50ea</td> <td>110,110</td> </tr> </tbody> </table>	Pk.	Price, ₩	50ea	110,110	50ea	110,110	50ea	110,110
Pk.	Price, ₩									
50ea	110,110									
50ea	110,110									
50ea	110,110									

MUTO® Disposable Trimming Knife, Dispenser type with Handle, Stainless-steel Blade NEW

Ideal for Section Semi-fixed Organs & Tissues/Organs with Durability, <Japan-made>, 일회용 조직절단용 트리밍 칼



- Semi-fixed Organs, Mammary Gland, Hard Tissues, Hard Tissues with Fibers 등의 섹션에 용이.
 - * Easy Setting into Exclusive Handle
 - * Safety Stopper Prevents Knife to be Dropped from Dispenser
 - * Safe Disposal of Used Knife ;
- <M3>
- Insert Used Knife into the Container of Dispenser after Washing Attached Blood etc.

- DM.02.1004** (1) Stainless-Steel Trimming Knife, in Dispenser, 0.25mm, 18×130mm
- DM.02.1005** (2) , 18×260mm

Pk.	Price, ₩
50ea	173,030
50ea	283,140

Optional Accessories

- DM.02.1006** (3) Handle for Trimming Knife, 130mm
- DM.02.1007** (4) , 260mm

Ea.	Price, ₩
	94,380
	94,380



Premium Microscope Slide Glass, Plain- & Frost-type

DURAN® Premium Fine Slide Glass, Plain- & Frost-type NEW

45° Ground-edge, 고품질 슬라이드 글라스

- Produced from High Quality Soda-lime Glass of Hydrolytic Class 3
- Virtually Free from Surface Defects, Inclusions, Streaks and Bubbles
- * Ideally Suitable to Microscopy Applications.
- * Standard Dimensions : 25 × 75mm
- * Glass Thickness 1.0 ± 0.05mm
- * Ground Edges 45° : Suitable for handling with infections substance <L1>
- * Plain-type : Crystal Clear
- * Frost-type : Marking Area

DU.2355042 Slide Glass, Ground Edges 45°, Plain
DU.2355043 , Frosted End

Pk.	Price, ₩	Cs.	Price, ₩
50ea	6,090	20pk	118,030
50ea	7,220	20pk	139,940



Premium Edges 90°, Color Microscope Slide Glass

DURAN® Premium Color Fine Slide Glass, White · Blue · Yellow NEW

90° Ground-edges, 고품질 컬러 슬라이드 글라스

- Produced from High Quality Soda-lime Glass of Hydrolytic Class 3
- Virtually Free from Surface Defects, Inclusions, Streaks and Bubbles
- * Glass Thickness 1.0 ± 0.05mm
- * Standard Dimensions : 25 × 75mm
- * Ideally Suitable to Microscopy Applications.
- * Color Printing of the Label Field : Chemical-resistance
- * Ground Edges 90° with Round Corners : Ideal for use in Automatic Machines.

(1) for Manual

DU.2355044 Color Slide Glass, Ground Edge 90°, White
DU.2355045 , Blue
DU.2355046 , Yellow

Pk.	Price, ₩	Cs.	Price, ₩
50ea	8,510	20pk	164,990
50ea	8,510	20pk	164,990
50ea	8,510	20pk	164,990

(2) for Automatic, White, <Germany-made>

DU.2355024 Color Slides PRINT, Grounded Corner, White

Pk.	Price, ₩	Cs.	Price, ₩
50ea	13,340	30pk	387,850



Premium Edges 90°, Adhesive Fine Slide Glass

DURAN® Premium Adhesive Fine Slide Glass, White NEW

90° Ground-edge, 고품질 코팅 슬라이드 글라스

- Manufactured Using Specially Developed Process Technologies which Ensure Excellent Adhesion of Cells and Tissue Cuts.
- Produced from High Quality Soda-lime Glass
- Virtually Free from Surface Defects, Inclusions, Streaks and Bubbles
- * Glass Thickness 1.0 ± 0.05mm
- * Standard Dimensions : 25 × 75mm
- * Ideally Suitable to Microscopy Applications
- * Ground Edges 90° secured to use
- * Provided with Special Adhesives, Complex Preparation Techniques no longer Necessary
- * Reliable Attachment of Tissue Section Cytological Preparations

DU.2355048 Coated Slide Glass, Adhesive, with Standard Coating
DU.2355049 , Superior Adhesive, with Top Quality Coating

Pk.	Price, ₩	Cs.	Price, ₩
72ea	24,280	20pk	471,090
72ea	27,870	20pk	540,960



Premium Microscope Cover Glass For 18 × 18, 22 × 22

DURAN® Premium Microscope Cover Glass, Highly Transparent & Colorless NEW

No.1 ; 0.13~0.17mm- & No.1.5 ; 0.16~0.19mm-Thickness, 고품질 커버 글라스

- Produced from High Quality Soda-lime Glass of Hydrolytic Class3
- Practically Free from any Color Distortion because they are highly Transparent and Colorless
- * Absorption-free in the Visible Spectral Range
- * Highly Transparent and Colorless.
- * High Optical Homogeneity
- * UV-absorption and Suitable for Fluorescence Microscopy.
- * 100 or 200/pk : Vacuum Sealed

Standard-type, Thickness No. 1; 0.13~0.17mm

DU.2355050 Cover Glass, 18 × 18mm, 200pcs/pk, 5pk/cs
DU.2355051 , 22 × 22mm, 200pcs/pk, 5pk/cs
DU.2355052 , 24 × 40mm, 100pcs/pk, 10pk/cs
DU.2355053 , 24 × 50mm, 100pcs/pk, 10pk/cs
DU.2355055 , 24 × 60mm, 100pcs/pk, 10pk/cs

Pk.	Price, ₩	Cs.	Price, ₩
200ea	4,980	5pk	24,120
200ea	13,110	5pk	63,570
100ea	7,430	10pk	72,010
100ea	8,520	10pk	82,660
100ea	9,720	10pk	94,240

Automatic Cover Slipper, Thickness No. 1.5; 0.16~0.19 mm

DU.2355054 Cover Glass, 24 × 50mm, 100pcs/pk, 10pk/cs
DU.2355056 , 24 × 60mm, 100pcs/pk, 10pk/cs

Pk.	Price, ₩	Cs.	Price, ₩
100ea	9,460	10pk	91,740
100ea	9,430	10pk	91,420

Articles	Cat. No	Description
----------	---------	-------------

HistoTainer II™ Specimen Container, 50% Filled with 10% Neutral Buffered, NON Tamper Evident Screwcap, 20~120ml NEW
 Ideal for Collection · Transport · Storage of Histology Specimens, PP Container & PE Cap, <Canada-made>, 조직 표본 · 검사물 보관 용기



HistoTainer® Specimen Container with 10% Neutral Buffered Formalin



Packaged in Sturdy Cardboard Box with Handles for easy Carrying

- 50% Filling with 10% Neutral Buffered Formalin as a Fixative
 - Especially Designed for Collection, Transport and Storage of Histology Specimens
 - Shatter Resistant Polypropylene Containers
 - Eliminating most Problems of Leakage and Evaporation
 - Capinsert® : Color Cording on Top of the Closure
- ※ Applications : Microbiology, Drug Testing, Urin Analysis, Histology, Pathology

Features

- * Especially Designed for Collection, Transport and Storage of Histology Specimens
- * Shatterproof Container with Unique Leak-Resistant Seal : The Container have Flexibility in 95kPa Pressure, Can be used to Overlap Containers Prevented of Evaporation, Virgin, Translucent Polypropylene
- * White Ribbed Lids : Easy to Open as Wearing Gloves or Wet Hands
- * Stackable for Easy, Safe Storage * Can be Viewed without Having to Open the Lid
- * Container's Vertical Walls Offer Excellent Rigidity
- * All Materials Used in Manufacturing are Free from Latex
- * The HistoTainer™ II is half filled with a fixative. 10% Neutral Buffered Formalin penetrates quickly and fixes slowly. The Formalin is enhanced by a buffering capacity optimizing histological results by light microscopy and immunohistochemistry.
- * Warning Label : Easy to Write Patient Identification
- * Sturdy Cardboard Boxes Packaging : Easy to Move with Handle in Package
- * These Products should be Stored at Room Temperature in Upright Position

Directions for use :

1. Complete the Patient Identification Label
2. Place Container on a Flat Counter Surface
3. Open the Container with Care to Prevent Spillage
4. Keep Lid Near the Work Environment
5. Place Biopsy in the Pre-identified Container
6. Close and Tighten the Lid on Container with a Clockwise Motion until You Reach a Tight Closure
7. Process the Samples According to Specific Laboratory Needs Using the Same Precautions as Above

<L1>

Ordering

SP.M961.20	Container, HistoTainer, 20ml , ϕ 35 × h53mm
SP.M961.40	, 40ml , ϕ 48.5 × h53mm
SP.M961.60	, 60ml , ϕ 48 × h62mm
SP.M961.90	, 90ml , ϕ 58 × h62mm
SP.M961.120	, 120ml, ϕ 58 × h77.5mm

Pk.	Price, ₩	Cs.	Price, ₩
24ea	26,900	4pk	99,610
24ea	24,080	4pk	89,160
24ea	26,220	4pk	97,100
24ea	33,210	4pk	122,970
24ea	37,010	4pk	137,070



Cap Insert, Colored

Optional Color Cap Insert

- * Use : For Separation of Samples depending on Colors.
- * Way of Use : Can be Inserted of Top of the Cap.
- * with Writing & Marking Area on Surface of Insert

SP.T345B	Cap Insert, Blue
SP.T345L	, Lilac
SP.T345R	, Red
SP.T345W	, White
SP.T345Y	, Yellow
SP.T345AS	, 5 × Color : Blue/Lilac/Red/White/Yellow

Pk.	Price, ₩	Cs.	Price, ₩
100ea	4,010	5pk	19,060
100ea	4,010	5pk	19,060
100ea	4,010	5pk	19,060
100ea	4,010	5pk	19,060
100ea	4,010	5pk	19,060
100ea	4,010	5pk	19,060

Wisdom 550°C High-temp Hi-Light Hotplate, "HP-D165", "HP-D200", Schott NEXTEMA® Ceramic Glass Plate NEW
 With ϕ 165 & ϕ 200mm Heating Zone, Digital Control, 2× Heating Control Mode, 다용도 하이라이트 고온가열판



2-Year Warranty

I. "HP-D165" ϕ 165mm Heating Zone
 ※Holding Stand Acceptable!

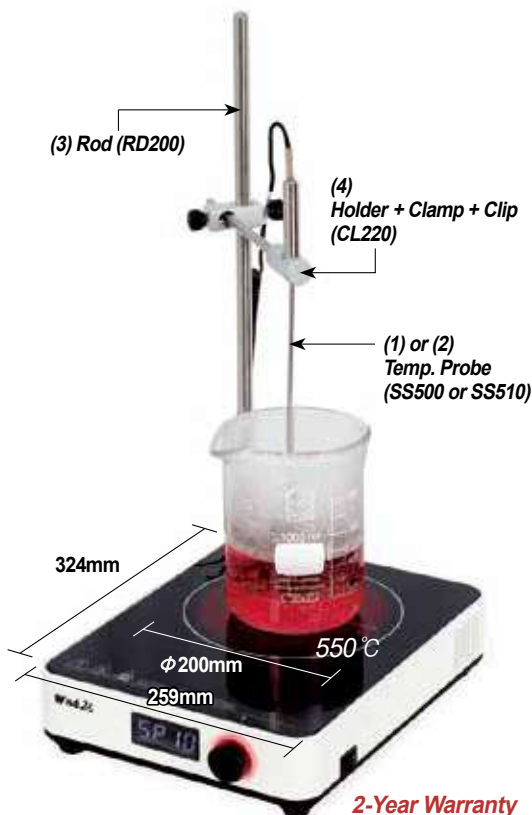

2-Year Warranty

II. "HP-D200" ϕ 200mm Heating Zone
 ※The Figure; Installation of
 Optional Rod, Holder, and Temp Probe

- Made in Korea ■ PL(Product Liability) Insurance
- Hi-Light Heating Element & Schott NEXTEMA® Ceramic Glass Plate.
- 2× Heating Control Mode : Max 550°C Heating Control
 - Standard Mode : 10-steps Heating Mode without Optional External Temp. Probe.
 - Precise Control Mode : 5°C Control Resolution with Optional External Temp. Probe.
- Patented Jog Dial Control System
- with Certificate & Traceability : Controlled by Serial Number, Certificat Delivery-information, and Traceable Data Base System

* High Temperature Indication LED Lamp for Prevention of Burn.
 * Can be used with Optional External Temperature Probe for Precise Control Mode

Specifications & Ordering Information

<L1>

Spec.	Model	I. "HP-D165" ϕ 165mm Heating Zone	II. "HP-D200" ϕ 200mm Heating Zone
Capacity		Max. 10Lit.	
Temp. Range & Accuracy		100°C~550°C & \pm 1.5°C at 330°C	
Plate Size & Heating Zone		224×289mm, ϕ 165mm	259×324mm, ϕ 200mm
Heater & Heating Power		Hi-Light Heating Element	
		1,100W	1,800W
Timer & Alarm		99hr 59min (with Continuous Run), Error	
Controller & Display		Digital Controller & LED Display	
2× Heating Control Mode		* Standard Mode : 10-Steps Heating Control Mode without Optional External Temp. Probe	
		* Precise Control Mode : 100°C~500°C Temperature Range Control (5°C Control Resolution) with Optional External Temp. Probe	
Material		* Plate : Schott NEXTEMA® Ceramic Glass Plate. * Housing : PBT & PC	
Dimension(w×d×h) & Weight		231×276×h65mm, 3kg	266×311×h65mm, 4kg
Electrical Reqts.		1Phase, AC230V, 50/60Hz	
Cat. No.		DH.HtpD0165	DH.HtpD0200
Price, Each. ₩		310,000	324,000

* Other Specifications are available upon Customer's Request.

Optional Accessories

		Ea. Price, ₩
DH.WHP503060	(1) External / Direct Contact Temp. Probe, "SS500", Stainless-steel, ϕ 4×L250mm, Cable L190mm	53,000
DH.WHP503061	(2) External / Direct Contact Temp. Probe, "SS510", Teflon Coated, ϕ 4×L250mm, Cable L190mm,	62,000
DH.WHP503036	(3) Stand Rod "RD200", Stainless-steel, ϕ 12×L450mm, 1.5p screw	23,000
DH.WHP503012	(4) Holder/Clamp/Clip, "CL220", for Temp. Probe	30,000



(1) Stainless-steel Temp. Probe



(2) Teflon Coated Temp. Probe



(3) Stand Rod "RD200", Stainless-steel

(4) Holder / Clamp / Clip for Temp. Probe

Articles	Cat. No	Description				
		<p>Buffalo® Cooling-Bag, 29Lit, PVC & PE, 12Hours Lasting With Convenient Shoulder Strap and Velcro Handle, Multi Purpose, 콜링백, 12시간 보온유지 보냉백 NEW</p> <p>■ 최대 12시간 지속되는 보냉 · 보온효과의 보냉백</p> <p>* Light Cool & Warm Bag * Generous 29Lit Capacity * Last up to 12 Hours</p> <p>* Lining PVC & Interior PE * Strap for Shoulder * Velcro to Hold the Handle</p> <p>BFL.221 Cooling-Bag, 430×200×340mm / 654g, Color : Black</p>				
		<p><B4></p> <table border="1" style="float: right;"> <tr> <th style="width: 50%;">Ea.</th> <th style="width: 50%;">Price, ₩</th> </tr> <tr> <td></td> <td align="right">21,170</td> </tr> </table>	Ea.	Price, ₩		21,170
Ea.	Price, ₩					
	21,170					

PS Foam Ice Box, for Easy-handling, Comfort Opening and Closing, 8 · 15 · 23 · 49 Lit, 냉동박스

- * Easy-handling type Comfort Design. * Low Density Styrofoam (Insulation Effect Excellent) is Used.
- * Superior Thermal Retention keeps Food and Beverages Cold

																							
(1) Ice Box, 8ℓ	(2) Ice Box, 15ℓ	(3) Ice Box, 23ℓ	(4) Ice Box, 49ℓ																				
<p>W2.IP8L (1) Ice Box, 8Lit, 312×215×h300mm (outside)</p> <p>W2.IP15L (2) , 15Lit, 355×238×h340mm (outside)</p> <p>W2.IP23L (3) , 23Lit, 425×272×h385mm (outside)</p> <p>DH.Box3011 (4) , 49Lit, 600×380×h380mm (outside) New</p>			<p><B4></p> <table border="1" style="float: right;"> <tr> <th style="width: 25%;">Ea.</th> <th style="width: 25%;">Price, ₩</th> <th style="width: 25%;">Cs.</th> <th style="width: 25%;">Price, ₩</th> </tr> <tr> <td></td> <td align="right">12,310</td> <td align="right">8ea</td> <td align="right">95,460</td> </tr> <tr> <td></td> <td align="right">15,250</td> <td align="right">4ea</td> <td align="right">59,120</td> </tr> <tr> <td></td> <td align="right">22,150</td> <td align="right">4ea</td> <td align="right">85,890</td> </tr> <tr> <td></td> <td align="right">63,000</td> <td></td> <td></td> </tr> </table>	Ea.	Price, ₩	Cs.	Price, ₩		12,310	8ea	95,460		15,250	4ea	59,120		22,150	4ea	85,890		63,000		
Ea.	Price, ₩	Cs.	Price, ₩																				
	12,310	8ea	95,460																				
	15,250	4ea	59,120																				
	22,150	4ea	85,890																				
	63,000																						

Ice Makers



Ice Maker Snow-type "IMS"

DAIHAN® 50 & 80kg Automatic Ice Maker, Snow-type "IMS" & Flake-type "IMF" NEW
 With Fully Automatic System, Uniform Ice, Production & Storage, 아이스메이커

- **PL(Product Liability) Insurance** ■ **No Separate Storage Bin Required.**
- **Full Automatic System : Continuous Ice Production**
- **Snow Type : Soft Particles in the Form of Rolling Carve**
- Flake Type : A Uniform, Rigid Ice Particle in the Form of Screw Turbine**

- * Ice Production and Storage Function at the Same Time
- * Useful in Medical Labs, Pharmaceutical Industry, Scientific Labs, Restaurants and Super markets in General.
- * Creates Uniform Ice with Minimal Water. * R404 Refrigerant and Ozone Friendly
- * Safety Water Level Sensor & Ice Level Sensor
- * Consists of Main Unit, Supply Hose, Drain Hose, Scoop, Power Cable, Operation Manual
- * Optional Water Pump

Specifications & Ordering information

Spec.	Model	"IMS50"	"IMF80"
Ice Type		Snow-type	Flake-type
Production / Day		50 kg	80 kg
Storage Capacity		25 Lit	58 Lit
Compressor		1/2 HP, R404A	1/3 HP, R404A
Door		Front PC Door	
Safety Circuit		Power Circuit Breaker, Ice Level Sensor, Water Level Sensor	
Dimensions (w×d×h)		360×440×620mm	600×560×740mm
Weight		40 kg	61 kg
Power Consumption		650 W	800 W
Electric Reqts.		230V, 50 or 60Hz	
Cat. No.	60Hz	DH.ims8050	DH.imf8080
	50Hz	DH.ims8055	DH.imf8085
Price, Each. ₩		3,146,000	4,153,000

* Other Specifications are available upon Customer's Request.

※ 윤임 착불



Ice Maker Flake-type "IMF"

Optional Accessory

DH.ImPu1001 Water Pump for "IMS" & "IMF"

Ea.	Price, ₩
	394,000



SciLab® Unique Black Write-On Label Dispenser, for Label Tape, S · M · L-size NEW
 With Smooth Writing Platform and Serrated Cutting Edge, Stable Footprint, 라벨 디스펜서

■ **Made in Korea**

- * Made of Unique Black Stainless-steel * Making Labeling Easy and Fast
- * Various Width and Color Tape Rolls can be Mixed together on Spindles

<L3>

SL.Dis7120	Label Dispenser, 240 × 120 × h96mm, Spindle od-φ 76 × 33mm
SL.Dis7121	, 255 × 160 × h93mm, -φ 76 × 55mm
SL.Dis7122	, 255 × 210 × h93mm, -φ 76 × 135mm

Ea.	Price, ₩
	38,970
	48,710
	60,400

Articles	Cat. No	Description
----------	---------	-------------

SB® Aluminum Magnet Level, Powder Coating, Length 100~2,000mm NEW
 With or Without Strong Rubber Magnet, 알루미늄 자석수평기

- * Built-in Strong Magnet : Strong Adsorption & Can work with Both Hands During Construction Metallic Materials
- * Easy to Carry Aluminum Box Body : Made Thicker to Increase Durability.
- * Powder Coating : Neat Appearance & Pollution-resistant
- * Special Fixed-vial : No Shaking, No Static, No Fading-UV Blocking
- * Vial Degree : $\pm 1.18\text{mm} / 1\text{M}=0.067^\circ$
- * Transparent Shock Protection Cover is Attached
- * Polished Flat Measuring Surface (Flat Degree : Within 0.1mm/m)



(1) Aluminum Magnet Level, with Strong Rubber Magnet

		Ea.	Price, ₩
S3.MML100	Level, Magnet, L100mm		10,080
S3.MML150	, L150mm		12,100
S3.NHMV3.12	, L300mm(12")		16,950
S3.NHMV3.18	, L450mm(18")		20,030
S3.NHMV3.24	, L600mm(24")		22,680
S3.NHMV3.36	, L900mm(36")		31,640
S3.NHMV3.40	, L1000mm(40")		35,840
S3.NHMV3.48	, L1200mm(48")		38,360
S3.NHMV4.60	, L1500mm(60")		50,120
S3.NHMV4.72	, L1800mm(72")		56,000
S3.NHMV4.80	, L2000mm(80")		59,920

(2) Aluminum Magnet Level, without Strong Rubber Magnet

		Ea.	Price, ₩
S3.NHV3.12	Level, Magnet, L300mm(12")		10,640
S3.NHV3.18	, L450mm(18")		11,760
S3.NHV3.24	, L600mm(24")		13,440
S3.NHV3.36	, L900mm(36")		19,040
S3.NHV3.40	, L1000mm(40")		20,310
S3.NHV3.48	, L1200mm(48")		23,240
S3.NHV4.60	, L1500mm(60")		30,390
S3.NHV4.72	, L1800mm(72")		34,310
S3.NHV4.80	, L2000mm(80")		38,920



(1) Round Type Vial Level



(2) Tube Type Vial Level

SB® Vial Level, with Round Type ($\phi 10 \cdot 15 \cdot 17\text{mm}$) & Tube Type ($\phi 6.5$ & 9.5mm), 바이알 수평기

(1) Round Type

* Used Attach the Electronic Balance / Machinery to Confirm the Level

S3.VR10	Vial Level, Round, $\phi 10 \times 8.0\text{mm}$
S3.VR15	, $\phi 15 \times 8.0\text{mm}$
S3.VR17	, $\phi 17 \times 8.0\text{mm}$
S3.VR25	, $\phi 25 \times 14\text{mm}$ New

(2) Tube Type

S3.VS29	Vial Level, Tube, $\phi 6.5 \times 29\text{mm}$
S3.VS30	, $\phi 9.5 \times 30\text{mm}$
S3.VS37	, $\phi 9.5 \times 37\text{mm}$
S3.VS40	, $\phi 12 \times 40\text{mm}$ New

<B4>		
Ea. Price, ₩	Cs.	Price, ₩
1,400	10ea	
1,400	10ea	
1,400	10ea	
1,400	10ea	

Ea. Price, ₩	Cs.	Price, ₩
710	10ea	
710	10ea	
710	10ea	
710	10ea	

Articles

Cat. No

Description

광폭 수평기, Wide Level KOREA

NEW 

▲ WL-600

<B4>

ORDER NO.	MODEL NO.	PRICE, ₩ Ea.	규격(mm)	포장단위 Ea. / Cs.
S3.WL600	WL-600	27,410	600(24")	
S3.WL1000	WL-1000	35,530	1000(40")	
S3.WL1500	WL-1500	57,340	1500(60")	1 / 10
S3.WL1800	WL-1800	65,720	1800(72")	
S3.WL2000	WL-2000	70,770	2000(80")	
S3.WL2400	WL-2400	100,960	2400(95")	1 / 10

콤비 수평기, Torpedo Magnetic Level KOREA

NEW 

■ Aluminum Base

<B4>

ORDER NO.	MODEL NO.	PRICE, ₩ Ea.	규격(mm)	포장단위 Ea. / Cs.
S3.CIV39	CIV 3-9	12,040	230(9")	1 / 24

슬렌트 레벨, Slant Level KOREA

NEW 

▲ TL-100 (일반)

▲ TL-100M (자석)

- 수평을 비롯 임의의 각도 측정에 용이
- 구배각 작업에 편리하며, 작업면을 기준한 상대적 각도를 직접 구할 수 있음
- 내구성이 높은 ABS 재질의 몸체에 자석을 부착하여 양손작업 및 철재 시공에도 편리하게 설계
- 130°까지 표기된 큰 각도판은 사용 측정값을 쉽게 확인
- 특수 고정된 바이알은 흔들림이 없고 정전기가 일어나지 않으며, UV차단처리로 색바래미 없음

<B4>

ORDER NO.	MODEL NO.	PRICE, ₩ Ea.	규격(mm) (가로×세로×두께)	포장단위 Ea. / Pk.
▶ S3.TL100	TL-100(일반)	16,770	320×155×28	1 / 8
▶ S3.TL100M	TL-100M(자석)	21,810	320×155×28	1 / 8

EXP 미니 레이저 레벨, Mini Laser Level 다국적

NEW 

1V 1H

구성품

- 본체 (Green), L자형 브라켓, AA 배터리x2, 파우치
- 정밀도 : ±3mm/10m
- 사용시간 : 13시간
- 전원 : AA 배터리
- 작업범위 : 직경 20m
- 출력 : ELL-11G : 30mw(6배 밝기)
- Size : 66×47×h70.5mm, 0.19kg

<B3>

ORDER NO.	MODEL NO.	PRICE, ₩ Ea.	레이저 색상	포장단위 Ea. / Cs.
0502-205	ELL-11G	83,310	그린	1 / 40

EXP 3D 레이저 레벨, 3D Laser Level 다국적

NEW 

2V(360°) 1H(360°)

▲ ELL-18650 (충전기) ▲ ELL-3DG (3D 레이저 레벨)

구성품

- 본체 (Green), 타겟 플레이트, 리튬이온 배터리 (ELL-18650)×2EA, 마그네틱 브라켓, 아답터, 충전기, 알루미늄 케이스
- 정밀도 : ±2mm/10m
- 사용시간 : 8시간
- 전원 : 7.4-2000mAh/리튬이온배터리
- 작업범위 : 직경 20m
- 출력 : 30mw(6배 밝기)
- Size : 120×88.5×h129mm, 0.55kg
- 레이저 색상 : 그린

<B3>

ORDER NO.	MODEL NO.	PRICE, ₩ Ea.	포장단위 Ea. / Cs.
▶ 0502-207	ELL-3DG (3D 레이저 레벨)	289,110	1 / 8
▶ 0515-827	ELL-18650 (충전기)	14,710	1 / 1



Sincon 자동레벨, Auto Level 다국적

- 망원경부가 고체질소가스로 봉입되어 습지나 터널 작업에도 방수효과를 발휘
- 1km 왕복오차 ±1.0mm

<B3>

ORDER NO.	MODEL NO.	PRICE	배출
0352-496	S-32	185,910	32배

Articles	Cat. No	Description						
		LED Desk Lamp with Stable Light, Flicker Free, Adjustable Brightness Up to 1300Lux NEW With Adjustable Head & Body, Anti-Glare, LED 데스크 램프						
		■ 5단계 밝기 조절과 2단계 각도 조절 기능이 있는 LED 스탠드 * Eliminates Multiple Shadow and Prevents Disruption to Reading * Provide Uniform, Soft, and Flicker Free Light : Minimize Eye Fatigue * Brightness Level Stage : 5 Level * Adjustable Head & Body : Free Angle Control * Color Temperature : Daylight(5500K) * Power Supply : AC 240V, 8W	<B4> <table border="1"> <tr> <th>Ea.</th> <th>Price, ₩</th> </tr> <tr> <td></td> <td>32,630</td> </tr> <tr> <td></td> <td>32,630</td> </tr> </table>	Ea.	Price, ₩		32,630	
Ea.	Price, ₩							
	32,630							
	32,630							
	DH.Lam3001	LED Desk Lamp, 8W, 180×315×h420mm, 700g, White						
	DH.Lam3002	, Black						

		USB Rechargeable LED Stand with Flicker Free, Adjustable Brightness Up to 300Lux NEW With Adjustable Head, Anti-Glare, USB Rechargeable Battery, USB 충전형 LED 스탠드				
		■ 3단계 밝기 조절과 각도 조절 기능이 있는 이동식 충전형 LED 스탠드 * Provide Uniform, Soft, and Flicker Free Light : Minimize Eye Fatigue * Brightness Level Stage : 3 Level * Adjustable Head Free Angle * Usage Time : 5hr(1Level), 4hr(2Level), 3hr(3Level) * Full Charging Time : 3hr * 3.7V 1200mAh Rechargeable Battery * Power Supply : 5V, 1A USB Cable 1m (Included)	<B4> <table border="1"> <tr> <th>Ea.</th> <th>Price, ₩</th> </tr> <tr> <td></td> <td>16,800</td> </tr> </table>	Ea.	Price, ₩	
Ea.	Price, ₩					
	16,800					
	DH.Lam3021	USB Rechargeable LED Stand, 80×100×h270mm, 300g, White				

		Removable LED Wall Sconce Light with on-off Switch, Daylight NEW Ideal for Bedroom, Stairs, Hallway, Restroom, 벽등, 콘센트 부착형				
		■ 은은한 조명으로 침실, 복도, 계단에 고정형으로 사용 * Used by Attaching to Power Receptacle * Easy Operation with on-off Switch * Color Temperature : Daylight * Small Size Simple Design * Long Life without Lamp Replacement * Power Supply : AC 250V, 1W	<B4> <table border="1"> <tr> <th>Ea.</th> <th>Price, ₩</th> </tr> <tr> <td></td> <td>2,400</td> </tr> </table>	Ea.	Price, ₩	
Ea.	Price, ₩					
	2,400					
	DH.Lam3026	Removable LED Wall Sconce Light, 40×45×107mm, 50g				

LED 레이저 포인트 다국적

Laser Point (LED Light)

NEW

■ 강력한 LED 라이트
 ■ 국제규격 CE인증 레이저포인트
 ■ 수은건전지 3개 내장

사용동영상

<B3>

ORDER NO.	MODEL NO.	PRICE, ₩ Ea.	포장단위 Ea. / Pk.
0432-659	TU211	10,080	1 / 6

LED 라이트 CHINA

LED Pen Light

NEW

■ 밝기 : 20 루멘
 ■ 발광다이오드 LED 적용
 ■ 줌기능
 ■ 원터치 전원버튼
 ■ 포켓 클립 장착
 ■ 배터리 별도; AAA×2

<B3>

ORDER NO.	MODEL NO.	PRICE, ₩ Ea.	포장단위 Ea. / Pk.
0309-618	WS-0428	4,710	1 / 24

NEBO 팔 플러스 충전 라이트 다국적

PAL PLUS Light

Rechargeable **NEW**

■ 3단계 밝기모드
 ■ 최대밝기 : 400루멘
 ■ 사용시간 : 최대 13시간
 ■ 보조배터리 기능
 ■ 분리가능한 접이식 나이프
 ■ KC 인증 충전식 건전지 내장

<B3>

ORDER NO.	MODEL NO.	PRICE, ₩ Ea.	포장단위 Ea. / Pk.
0519-143	NE6715	31,920	1 / 12

KDY LED 충전 라이트, 1000루멘, LED Light Rechargeable 다국적

LED 충전 라이트, 1000루멘, LED Light Rechargeable

NEW

■ LED : CREE XM L2
 ■ 밝기 : 최대 1,000루멘
 ■ 재질 : 알루미늄

■ 사용시간 : 최대 7시간
 ■ 충전시간 : 5시간 USB충전(Micro 5pin)
 ■ 크기 : 128×27(mm)

포켓클립 거치대 포함

<B3>

ORDER NO.	MODEL NO.	PRICE, ₩ Ea.	포장단위 Ea. / Pk.
0463-169	KLL-128	24,510	1 / 10

LED 방수 라이트, Waterproof LED Light, IPX4 & IPX8-Class CHINA

(1) IPX-4 생활방수급, 140 루멘

- 사용시간 : MAX 4h
- 길이 113mm
- 무게 80g
- IPX4(생활방수)



<B3>

ORDER NO.	MODEL NO.	PRICE, ₩	밝기	배터리
0478-440	P5 500895	63,620	140루멘	AA×1

(2) IPX-8 2.5m까지 방수, 400 루멘

- 밝기 : MAX 400lm – Min 60lm
- 사용시간 : MAX 3.5h MIN 2h
- 길이 90mm
- 무게 70g
- IPX8(2.5M 까지 방수 가능)



ORDER NO.	MODEL NO.	PRICE, ₩	밝기	배터리
0478-439	8701 F1	84,250	400루멘	CR123×1

LED 라이트, LED Light CHINA

(1) 크리 Q3 줄라이트

- 밝기 : 170 루멘
- Q3 LED 칩 적용
- 줌기능
- 원터치 전원버튼, 체크링 가공의 미끄럼 방지
- 배터리 포함



<B3>

ORDER NO.	MODEL NO.	PRICE, ₩ Ea.	배터리	포장단위 Ea. / Pk.
0309-621	WS-M3	11,470	AAA×3	1 / 30

(2) 13구 LED 랜턴

- 13구 LED
- 10시간 연속 사용 가능
- 원터치 전원버튼, 생활방수
- 배터리 별도



ORDER NO.	MODEL NO.	PRICE, ₩ Ea.	배터리	포장단위 Ea. / Pk.
0279-737	WS-0350	6,670	6V사각×1	1 / 24



Buffalo® Portable Slide Lantern, Convenient Handle, Compact Size, 85×125~182mm Excellent Durability, 8 Hours, Battery AA×3ea, 슬라이드 랜턴

■ 편리하고 간편한 사이즈, 환한 밝기

- * Powerful LED Brightness
- * Convenient Handle
- * Compact Size
- * Convenient On & Off
- * Excellent Durability
- * Battery AA×3ea
- * Up to 8 Hours Continuous
- * 85×125~182mm

<B4>

BFL.301 Portable Slide Lantern, Battery AA×3ea, 85×125~182mm

Ea.	Price, ₩
	7,560



Buffalo® Portable Iron Lantern, Portability, 2-Step Brightness Control, 120×220mm 200 Lumen, 15 Hours, 3 Side LED Light, Minimal Size, 아이언 랜턴

■ 휴대가 간편한 미니멀 사이즈, 2단계 밝기 조절

- * 15 Hours Battery Time with 200 Lumen Max Brightness
- * Easy to Carry with Minimal Size
- * Easy to Control 2-Step Brightness
- * Easy to Replace Battery

<B4>

BFL.306 Portable Iron Lantern, 3 Side LED Light, 120×220mm, D Battery×4ea

Ea.	Price, ₩
	19,660

LED 헤드랜턴, 충전식, LED Rechargeable Head Light, 110루멘 다국적



다양하게 사용가능



180도 각도조절 가능

- LED : COB 2W
- 밝기 : 최대 110루멘
- 재질 : ABS
- 사용시간 : 최대4.5시간
- 충전시간 : 2시간 USB충전(Micro 5pin)
- 크기 : 70×34(mm)

<B3>

ORDER NO.	MODEL NO.	Ea. PRICE, ₩	무게	포장단위 Ea. / Pk.
0485-899	KML-110	16,470	87g	1 / 25

Articles	Cat. No	Description
----------	---------	-------------

LED 헤드랜턴(광역), LED Wide-range Head Light

CHINA

(1) Q3 줌 헤드랜턴, 200 루멘, DC Battery-type

- 밝기 : 200루멘
- V6 LED칩 적용
- 상,하 90도 각도조절
- 4단계 멀티모드 지원
- 줌인, 줌아웃 포커싱 기능
- 배터리 별도(AAA×1)



<B3>

ORDER NO.	MODEL NO.	Ea. PRICE, ₩	무게	포장단위 Ea. / Pk.
0290-964	WS-009H	10,590	103g	1 / 30

(2) XML-U2 충전줌 헤드랜턴, 1050 루멘, Rechargeable-type

- 밝기 : 1050루멘
- CREE XML U2 LED 칩 적용
- 상,하 90도 각도조절
- 3단계 멀티모드 지원
- 줌인, 줌아웃 포커싱 기능
- 마이크로 5핀 충전케이블로 충전 가능
- AAA배터리 겸용으로 사용가능
- 배터리 포함(18650×1)



ORDER NO.	MODEL NO.	Ea. PRICE, ₩	무게	색상	Ea. / Pk.
0403-989	WS-H330	23,730	155g	블루	1 / 6
0406-347				레드	

(3) 제우스 충전 헤드랜턴, 1600 루멘, Rechargeable

- 밝기 : 1600루멘
- CREE XML2-U3 메인, Q6 사이드 칩 적용
- 상,하 90도 각도조절
- 4단계 멀티모드 지원
- 마이크로 5핀 충전케이블로 충전 가능
- 파우치, 배터리 포함(18650×1)



ORDER NO.	MODEL NO.	Ea. PRICE, ₩	무게	포장단위 Ea. / Pk.
0467-398	WS-H380	28,920	197g	1 / 6

(4) 충전식 광폭 헤드랜턴, 20W COB, Rechargeable-type

- 최신 20W COB LED 적용
- 상,하 120도 각도조절
- 3단계 멀티모드 지원
- 마이크로 5핀 충전케이블로 충전 가능
- 배터리 포함(18650×1)



ORDER NO.	MODEL NO.	Ea. PRICE, ₩	무게	포장단위 Ea. / Pk.
0483-772	WS-H300	21,080	173g	1 / 6

※ Batteries for Lights/Lanterns : See the "Dry-Cells / Batteries" Section !

작업등 Work Light, (1) Cable-type, (2) Cordless Rechargeable RED-type

KOREA



(1) KL-201



(2) AP-1001

(1) Cable형 작업등

- 0275-895 작업등60W(전구별도), "KL-201", 7m cable
- 0283-007 "KL-203", 15m cable

(2) LED충전형, Cordless Rechargeable type, 230×58×47mm

- 스마트폰 5핀 충전기 활용, LG Battery 내장
- 연속 5~10시간 단계별 조절사용
- 과충전, 과방전, 과전류 안전장치 적용

- 0432-087 LED등, "AP-1000", 직진형, 800/1600루멘, 5hr사용
- 0459-443 "AP-1001", 확산형, 500/1100루멘, 3/6hr사용

<B3>

Ea.	Price, ₩
	8,560
	14,260

Ea.	Price, ₩
	35,500
	35,500



(1) 주광 백색 (2) 태양 주황색

LED Bulb, Daylight & Soft White, 8~15W, 6,500 & 3,000K, LED 전구

* Lifetime : approx. 15,000 Hours * Rated Voltage 220V, 60Hz.

<B4>

Description	(1) Daylight, 6500K (주광색, 백색)		(2) Soft White, 3000K (전구색, 옐로우)	
	Cat. No.	Ea. Price, ₩	Cat. No.	Ea. Price, ₩
LED Bulb, 8W, φ60×h105mm	DH.Bul1001	1,280	DH.Bul1006	1,280
LED Bulb, 10W, φ60×h105mm	DH.Bul1002	1,450	DH.Bul1007	1,450
LED Bulb, 12W, φ60×h116mm	DH.Bul1003	1,610	DH.Bul1008	1,610
LED Bulb, 15W, φ80×h150mm	DH.Bul1004	2,470	DH.Bul1009	2,470

Articles

Cat. No

Description

그리스, Grease KOREA

■ 밝고 투명하며 점착력이 우수한 황갈색 구리스로 리튬타입 증주제를 사용한 산업용 고급 리튬 구리스



ORDER NO.	MODEL NO.	PRICE, ₩ Ea.	주도	용량(kg)	포장단위 Ea. / Cs.
▶ 0305-037		3,480		0.5	1 / 24
▶ 0305-039	GREASE 2	18,630	2	3	1 / 6
▶ 0305-040		70,770		15	1 / 1

유압 작동유, Hydraulic Fluid KOREA

■ 각종 산업 및 차량 장비의 유압 장치에 적합하도록 녹/산화/거품 방지제를 첨가하여 제조한 유압 작동유 및 범용 산업 기계유
 ■ 란도에서 RD HD로 모델명 변경됨.



ORDER NO.	MODEL NO.	PRICE, ₩ Ea.	점도	용량(ℓ)	포장단위 Ea. / Cs.
▶ 0304-999	RD HD 32	57,440	32		
▶ 0305-000	RD HD 46	57,440	46	20	1 / 1
▶ 0305-001	RD HD 68	57,440	68		
▶ 0518-162	RD HD 46	14,710	46	4	1 / 4

분무 윤활 방청제, Spray, Multi-Lubricant for Anti-Rust/Corrosion/Moisture KOREA



■ 금속 부위의 녹 방지; Spray, 450ml는 Straw-type
 ■ 문이나 창문, 의자 등 잡음 제거
 ■ 방청 · 부식 방지/제습 · 방습 작용
 ■ 침투/윤활/세척 작용

ORDER NO.	MODEL NO.	PRICE, ₩ Ea.	용량	포장단위 Ea. / Cs.
① 0493-740		2,510	78ml	1 / 30
② 0442-905	WD-40	3,670	220ml	1 / 35
③ 0468-629		5,000	360ml	1 / 24
④ 0470-691	WD-40 (스트로우타입)	5,730	450ml	1 / 24



3M® "W100" Premium Lubricant Spray, Excellent Lubricating, Excellent Anti-corrosion, 230g

Remove Moist, High Penetration, Cleanliness, 프리미엄 윤활 방청제

■ 금속 표면에 얇고 부드러운 보호막 형성하여 습기와 공기 차단
 ■ 수분흡착 방지 및 수분 분리 ■ 얇은 유막 형성으로 매끄럽고 우수한 윤활 성능 보유
 * Strong Penetration that Directly Permeates Metal Fine Holes and Releases Impurities to Protect Metal Surfaces as well as Prevent Rust
 * Lange of Use : Small Electric Motor, Sounding Operating Part, Hinge

3M.08.W100	"W100" Lubricant, Spray-type, 230g	Ea. Price, ₩	Cs.	Price, ₩
		4,040	12ea	



3M® "K-70" Premium Lubricant Spray, All-in-one Nozzle, 230g

Ideal for Rust Prevention, Strong Lubricating Effect, Noise Reduction, 프리미엄 윤활 방청제

■ 노즐 일체형으로 사용이 편리함 ■ 윤활 및 녹 방지 성능이 우수함. 부드러운 냄새로 기름제품의 역한 냄새를 줄임
 * Removing Rust or Corrosion-solified Machinery, Bolt and Nut, Window, Keyhole, Car Door gap
 * Lubricating Rust Prvention for Various Industrial Machine, Facility, Household Appliance

3M.08.K70	"K70" Lubricant, Premium, Aerosol-type, 230g	Ea. Price, ₩	Cs.	Price, ₩
		2,910	12ea	



3M® "MP131" Hi-Performance Waterproof Coating Agent, Spray 360g & Can 1Lit

■ 햇빛 등 자외선에 안정적인 투명 고무계 성분 함유 ■ 고 침투성으로, 방수막을 형성하는 코팅형 방수제 ■ 장기간 방수가 가능
 * Highly Elastic and High Solid Ingredients, Maintains Waterproofing for a long Time
 * Stable in Ultraviolet Ray and Excellent outdoor Waterproof Effect * Antifungus Minimize Dust Pollution
 * Excellent Waterproof Performance to Wall

3M.08.1021	(1) "MP131" Waterproof Coating, Spray 360g	Ea. Price, ₩	Cs.	Price, ₩
		6,250	12ea	
3M.08.1022	(2) , Fluid Can 1Lit	Ea. Price, ₩	Cs.	Price, ₩
		10,000	12ea	

Articles	Cat. No	Description
----------	---------	-------------

3M® Silicone Lubricant, 177°C Resist NEW
 Spray, Strong Effect, 255g **고온용 실리콘 윤활제**

- 얼룩이나 끈끈한 성질이 없어 재 오염 방지
- 방수효과와 방진효과
- * Anti-Corrosion Due to Waterproof Effect
- * Prevent Machine Failure Due to Dustproof Effect
- * Preventing Lubrication and Contamination of High-heat molds and Various Device
- * Highly durable, Enabling Long-term Use
- * Thin Film-type film with Plastic, Rubber, Leather Surface Wax, Ink, Paint & Protection against Contamination



NEW

<B4>

ORDER NO.	MODEL NO.	Ea. PRICE, ₩	용량	Ea. / Cs.
3M.08.1023	Silicone Lubricant, 255g	4,040	12ea	

NABAKEM® 유연 그리스, Liquid Grease, Spray NEW KOREA

- 장기윤활방청, 뛰어난 내구성, 낮은 마찰계수(0.07)
- 내화학적, 비 유동성, 불연성
- 드라이브 벨트, 가스켓, 패킹, 기어, 베어링, 슬라이브 코팅



NEW

<B3>

ORDER NO.	MODEL NO.	Ea. PRICE, ₩	용량(g)	Ea. / Cs.
0470-591	G-LUB 10M	10,690	500	1 / 20

NABAKEM® 에어툴용 오일, Air Tool Lubricant KOREA

- 에어 공구 보호용 윤활제
- 1회사용으로 18개월 지속 효과
- 작업시 소음을 현저히 감소
- 모든 내부 부품의 윤활작용과 습기제거 효과
- 부품 파손율을 약 80%까지 줄여줌
- 작업의 능률향상과 공구의 POWER가 증가



NEW

<B3>

ORDER NO.	MODEL NO.	Ea. PRICE, ₩	용량(ml)	Ea. / Cs.
0470-627	ATL-277	9,080	500	1 / 20

NABAKEM® 스테인리스 코팅제, Stainless-steel Coating, Spray KOREA

- 소재의 형상과 관계없이 균일한 두께의 스테인리스 피막을 형성
- 변색이 없음
- 미립자, SS 316L 분말로 만들어짐
- 내식성, 방청성, 내마모성이 우수



NEW

◀ 420ml

<B3>

ORDER NO.	MODEL NO.	Ea. PRICE, ₩	용량	Ea. / Cs.
▶ 0470-601	L-316	6,890	420ml	1 / 20

NABAKEM® 고온 나사 소부 방지제 (니켈), KOREA

High Temp. Anti-Seize Agent Spray

- 극압 및 고온윤활성, 고착방지 및 우수한 밀봉성
- 열분산 및 열안정성, 방청성 및 내부식성
- 내마모성 및 내약품성, 조립해체를 쉽게 함
- 내열온도 -60°C~1425°C



NEW

<B3>

ORDER NO.	MODEL NO.	Ea. PRICE, ₩	용량(ml)	Ea. / Cs.
0470-622	N-500	19,600	420	1 / 20

NABAKEM® 윤활제 이형제, Spray, Lubricant Release Agent KOREA

- 초고온용 백색 윤활 이형제
- 속건성으로 작업성 향상과 원가 절감 효과
- 내마모성이 우수
- 고온 윤활 이형성이 우수함 (내열온도1200°C)
- 금형부식성이 없음



NEW

<B3>

ORDER NO.	MODEL NO.	Ea. PRICE, ₩	용량(ml)	Ea. / Cs.
0470-618	B-N SPRAY	11,760	420	1 / 20

NABAKEM® 금형 이형제(실리콘), Mold Release(Silicone) Spray KOREA

NEW



◀ R-1



◀ R-2

▶ 용도 : Plastic 등 성형품을 금속틀에서 쉽게 빼내기 위해 바르는 물질

R-1

- ABS, PE, PP, etc. 금형 등에 사용
- 1차 가공용 이형제(도장 불가능)
- 우수한 이형작용, 속건성 타입으로 작업성이 우수
- 금형부식성이 없음, UL 인증 제품
- RoHS(6대 유해물질) 검출안됨

R-2

- 2차 가공용 이형제(도장 가능)
- 우수한 이형작용, 속건성 타입으로 작업성이 우수
- 식물성 원료 사용, 이형 후 세척과정을 거쳐 도장, 도금 등 후처리 공정 가능
- UL 인증 제품
- RoHS(6대 유해물질) 검출안됨

<B3>

ORDER NO.	MODEL NO.	PRICE, ₩ Ea.	용량(ml)	포장단위 Ea. / Cs.
▶ 0470-634	R-1	2,420	420	1 / 30
▶ 0470-635	R-2			

NEW



SAUTER® Compact Luxmeter, "SP200K", 0.1~200,000 Lux, Selectable Units : FC, Lux **NEW**
 With LED Light Measurement & Rotatable Sensor, Sturdy Protective Sensor Cover, 디지털 조도계

- **Supplied by SAUTER® in Germany**
- * Ideal for Measuring Illumination of Office Work & Production stations, etc
- * Sensor : Silicone Diode, Filtered
- * Cosine Correction for Incidence of Light at an Angle
- * Rotatable Sensor Unit (+90 and -180°) for Optimum Alignment to the Light Source
- * Sturdy Protective Cover for the Photo Sensor
- * TRACK Function for Continuous Recording of Variable Environmental Conditions
- * Peak Hold Function to Capture the Peak Value
- * Option of Fitting a Stand on the Rear of the Housing, 1/4" Thread
- * Optimised for Accurate Light Measurement
- * Easy to Toggle between Unit by a Keypress
- * Data-Hold Function
- * Provide a Soft Case for Impact Protection
- * Selectable Units : FC(Foot-Candle), Lux

Specifications & Ordering Information

<L1>

Compact Luxmeter, 0.1~200,000Lux



with Soft Case

Spec.	Model	SP200K			
		0-200	200-2000	2000-20000	2000-200000
Measuring range (lx)		0-200	200-2000	2000-20000	2000-200000
Readout (lx)		0.1	1	10	100
Precision up to 20,000 Lux		± (4% of the Result + 10 Scale Intervals)			
Precision From 20,000 Lux		± (5% of the Result + 10 Scale Intervals)			
Repeatability		± 2 %			
Temperature Error		± 0,1 %			
Measuring Frequency		2 Hz			
Battery		9V Battery, Operating Time up to 200 Hours			
Operating Temp. / Humidity		0 ~ 40 °C, Max. 80 % RH			
Dimensions (w×d×h)		185×68×38 mm, 130g			
Cat. No. & Price ₩		SA.SP200K		₩ 178,460 / Ea	

Articles	Cat. No	Description
----------	---------	-------------



filtratech® **Premium Bench Protective Paper**, Sheet & Roll-Type, for Prevent Impacts, Acids, Toxic
 Made of an Absorbent Paper & PE-Coated Film, <France-made>, **프리미엄 실험실 벤치 보호 매트** NEW

- 흡수성이 뛰어나 산, 유독성 유출물로부터 실험실 벤치 보호 및 실험자의 안전한 작업환경 유지
- **Efficient Protection of Laboratory Benches against Impacts, Acids, Toxic, Corrosive or Radioactive Fluids**
- **With an Absorbent Paper on one Side and with a PE-coated Film on the other.**
- **Absorption Capacity : 170 ml/m²**

* Weight Cellulose : 100g/m², PE : 25g/m²

(1) Sheet-Type

FL.PP125.F46L Bench Protective Paper, Sheet-Type, 46 × 57cm, 50sheets

Pk.	Price, ₩
50sheets	46,440

(2) Roll-Type

FL.PP125.R46 Bench Protective Paper, Roll-Type, w460mm × L50m
FL.PP125.R49 , w490mm × L50m

Roll.	Price, ₩
50m	106,240
50m	112,340

Back Side : PE-Coated



PVC Non-Slip Cutting Mat, Excellent for Self-Recovery, with Grid Line, Durable, 2.75mm Thick
 Ideal for Protect Work Surface & Blade, **PVC 논슬립 커팅 매트** NEW

- 칼자국을 스스로 회복하는 자체 복원력 우수
- **Suitable for All Kinds of Writing, Craft Paper Carving, Cutting, etc.**

* Protect Table-top From Scratches Caused by Sharp Tools or Glue

* Help Cutting More Convenient and Smooth

<B4>

DH.Off3005 Cutting Mat, PVC, Thick 2.75mm, 300 × 215mm
DH.Off3006 , 450 × 300mm
DH.Off3007 , 620 × 450mm
DH.Off3008 , 900 × 620mm

Ea.	Price, ₩	Pk.	Price, ₩
	2,820	10ea	27,230
	5,390	10ea	52,230
	10,430	30ea	303,330
	20,400	10ea	197,790

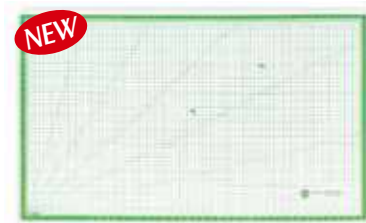

PP Non-Slip Cutting Mat, with 5 × 5mm Grid and 15° · 30° · 45° · 65° · 75° · 90° Angle Marking
 Excellent Self-Resilience, Protect Work Surface and Blade, 440 × 300mm, Thick 2mm, **논슬립 커팅 매트** NEW

- 4층 구조(4 Layers) : EVA PP - Homo PP - Homo PP - EVA PP

- EVA PP 재질(Material) : 미끄럼 방지(Non-Slip) 및 자체 복원력(Self-Resilience) 우수

- 5 × 5mm 의 격자무늬 와 15° · 30° · 45° · 65° · 75° · 90° 각도가 표시되어 커팅 작업에 최적화

* 3 Color will be Delivered Randomly (Black, Green, Yellow)

<B1>

DH.Off3009 Cutting Mat, PP, Non-Slip, 440 × 300mm, Thick 2mm

Ea.	Price, ₩
	7,640

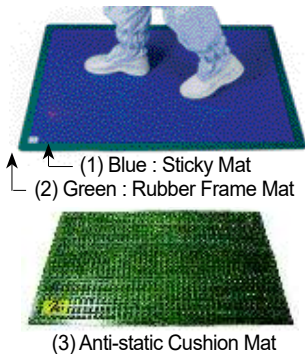

Sticky Mat, Class 1000, Clean Room Products, 30 Layers, 점성이 있는 필름재질 매트, 정전기 방지

- **Made in Korea** * Stop Dirt Contamination in the workplace

* For Hospital, Operating Room, Pharmaceutical · Biological · Semiconductor · Electronic manufacturing.

* 30 Layers : Use Each Sheet Many Times Before Peeling off.

<L3>

DH.Mat3001 (1) Sticky Mat, 600 × 900mm, t40_{µm} New
DH.Mat3002 , t32_{µm} New
N4.002 (2) Mat, Rubber Frame

Ea.	Price, ₩	Cs.	Price, ₩
	6,820	10ea	63,010
	6,050	10ea	56,000
	81,680		

Anti-Static (Anti-static Cushion Mat)

* Fatigue Resistant, Comfort, Non-Slip, Safety Mat.

N4.004 (3) Mat, Anti-static Cushion, 600 × 900 × t13mm

Ea.	Price, ₩
	122,520

3M® Nomad™ Rain Mat, High Absorbency, Quick Drying, with Latex Coated, Excellent for Moisture and Pollutant Absorption NEW

Ideal for Office · Store Entrances · etc, Durability, Non-Slip, Washable, **레인 매트, 현관 입구용**



- **비나 눈이 오는 날씨에 실내로 유입되는 수분을 효과적으로 흡수**

* Excellent for Moisture and Pollutant Absorption * Stable Adherence to Floor with Latex Coating

* Easy to move and Storage * Easy to Clean: Open Construction Allows Easy Cleaning

<B4>

3M.08.1031 Mat, Dark Grey, 690 × 900mm
3M.08.1032 , 900 × 1380mm

Ea.	Price, ₩	Cs.	Price, ₩
	26,930	12ea	
	53,850	12ea	

3M® Entrap Multipurpose Mat, PVC, Z-Web Structure, Durability, Excellent for Removing Dust / Moisture NEW

Ideal for Bathroom · Pool · Locker and other Wet Areas, Non-Slip, Washable, **욕실용 매트**

NEW

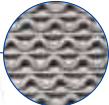

Z-Web Structure

- 욕실바닥, 발코니, 세탁실, 현관 등 다양한 곳에 사용 가능
- 물이 고이지 않고 빠르게 배출하는 Z-Web 구조의 욕실 매트
- * Exceptional Slip Resistance with Z-Web Wavy Design
- * Easy to Clean : Open Construction Allows Easy Cleaning

- * Drains Water Quickly Helping Keep Surfaces Drier
- * Antimicrobial Coating

<B4>

3M.08.1033 Mat, Grey, 690×900mm, Thickness 5mm
3M.08.1034 Red, 690×900mm, Thickness 5mm

Ea.	Price, ₩	Cs.	Price, ₩
	28,610	12ea	
	28,610	12ea	



다용도 불연/단열 그라스포 & 하이그라스포, Anti-Flame & Insulation Glass-Fiber Mat

다국적

NEW

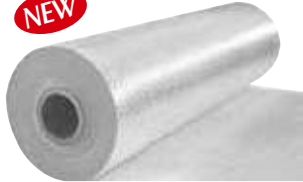

(1) 그라스포
350℃~550℃



(2) 하이그라스포
550℃~700℃

- 다용도 : 용접/용단시 단열 마감재, 단열/절연용 커버, 열차단커튼, 고온 파이프 절연, 깔개, 단열/보온 외 피재, 기타용도
- 특수 내열처리된 유리섬유실로 직조한 포직으로 기계적 특성 및 화학적 특성이 우수하여 고온에서 유연성 유지 및 인장강도가 우수함
- 내열 : (1) 그라스포 350℃~550℃ (2) 하이그라스포 550℃~700℃
- 하이그라스포는 절단시 날림현상이 없는 고품질 Mat임

<B3>

0355-375 (1) 그라스포, w1×L25m, T1.6mm Roll.
0355-378 (2) 하이그라스포, w1×L25m, T1.6mm Roll.

Ea.	Price, ₩
	71,160
	90,660

Kern® High Performance Compound Microscope “OBF-1” & “OBL-1”, Pre-centered, Koehler illumination, 40× ~ 1000× **NEW**
 With 3W LED illumination, Butterfly Tube, 1.25 Abbe Condenser, Fully-Equipped Mechanical Stage, 고성능 연구용 생물 현미경

■ Supplied by Kern® in Germany

NEW

3-Year
Warranty



Objectives OBF



Simple Polarizing Attachment

Darkfield Unit

LAB LINE

The High Performance Compound Microscope for Every Laboratory, Hospitals and Doctor's Practice with Fixed, Pre-centered Koehler illumination

Features

- The KERN OBF-1 and OBL-1 Models are Excellent, Stable Laboratory Microscopes for all Common Routine Applications
- Depending on the Application, there is a Choice of Models with Strong, Continuously Dimmable 3W LED.
- The Fixed, Pre-centred and Focusable 1,25 Abbe Condenser with Aperture Diaphragm and Field Diaphragm Gives you a Simplified Koehler illumination, without Having to Move the Centre
- The Large Mechanical Stage and its Specimen Holder Holds up to Two Samples at the Same Time , which can be Focused Quickly and Easily by a Coaxial Coarse and Fine Drive on both Sides
- A Large Selection of Eyepieces, Objectives and Color Filters as well as a Darkfield Condenser, a Simple Polarising Unit, Different Phase Contrast Kits through to HBO and LED Fluorescence Units are Available to you as Accessories
- A Protective Dust Cover, Eye Cups, as well as Multi-lingual user Instructions are Included in the Scope of Delivery
- A C-mount Adapter is Required to Connect a Camera to the Trinocular Version.

Technical Data & Applications

- Haematology, Urology, Gynaecology, Dermatology, Pathology, Microbiology and Parasitology, Immunology, Oncology, Entomology, Vets, Water Analysis, Breweries, Sewage Plants
- Translucent, Thin, Low-contrast, Challenging Samples (e.g. Living Mammal Cells, Bacteria, Tissues)
- Finite Optical System DIN (OBF) / Infinity Optical System (OBL)
- Quadplex Nosepiece (for 4× / 10× / 40× / 100× Objectives)
- Siedentopf 30° Inclined / 360° Rotatable
- Diopter Adjustment : One-sided
- Overall Dimensions : 395×200×h380 mm
- Net Weight approx. : 6.7 kg

STANDARD



OPTION



Cat. No.	Tube	Eyepiece	Objectives Quality	Objectives	Price (₩)
KE.OBF.123	Binocular	WF 10×/φ18mm	Plan	4× / 10× / 40× / 100×	1,627,100
KE.OBL.127	Binocular	WF 10×/φ20mm	Infinity E-Plan	4× / 10× / 40× / 100×	1,762,700
KE.OBL.137	Trinocular				1,870,110

Optional Accessories

- KE.OBB.A1345 Trinocular Tube for "OBF" Model
- KE.OBB.A1448 Eyepiece, HWF 10× / φ20mm, with Pointer
- HH.1133853 Immersion Oil, 100ml

Ea. Price, ₩
716,710
154,980
35,120

Kern® Professional Compound Microscope “OBN”, Professional Koehler illumination Unit, 5 Objectives, 40× ~ 1000× **NEW**
 With 3W LED illumination, Extremely Large Mechanical Stage, Modular System, 프로페셔널 다기능 생물 현미경

■ Supplied by Kern® in Germany



Quintuple PH Universal Rotary Condenser with 10× / 20× / 40× / 100×



Phase Contrast Rotary Condenser

PROFESSIONAL LINE

Professionalism and Versatility United in One Microscope – with Koehler illumination for Demanding Applications

Features

- The OBN Series Stands out because of its Unbeatable and Consistently High Quality and its Ergonomic Design. The Range of Modular Components Means that the OBN Series can be Individually Customized for the Professional User
- Depending on the Application, there is a Choice of Models with Strong, Continuously Dimmable 3W LED
- This Series has a Professional Koehler illumination Unit with an Adjustable Field Diaphragm as well as a Height-Adjustable 1,25 Abbe Condenser which can be Centred and which has an Adjustable Aperture Diaphragm
- The Extremely Large Mechanical Stage with Ergonomic, Coaxial Coarse and Fine Focusing Knob on both Sides Enables you to Adjust and Focus your Sample Rapidly and Accurately

- A Wide Variety of Modular Systems, such as, for example, a Wing-out Condenser, Various Eyepieces, Objectives, Color Filters, Phase Contrast Units, a Darkfield Condenser, a Simple Polarizing Unit, Butterfly Tube, through to Complete Fluorescence Units are Available to you as Accessories
- This centring eyepiece for adjusting the phase contrast (OBN 158), a protective dust cover, eye cups as well as Multi-lingual User Instructions are Included in the Scope of Delivery
- A C-mount Adapter is Required to Connect a Camera. You can Select this Adapter from the Following Model Outfit List

Technical Data & Applications

- Haematology, Urology, Gynaecology, Dermatology, Pathology, Microbiology and Parasitology, Immunology, Sewage Treatment Plants, Oncology, Entomology, Vets, Water Analysis and Breweries
- Translucent, Thin, Low-contrast, Challenging Samples (e.g. Living Mammal Cells, Bacteria, Tissue)
- Infinity Optical System
- Quintuple Nosepiece (for 4× / 10× / 20× / 40× / 100× Objectives)
- Siedentopf 30° Inclined / 360° Rotatable
- Diopter Adjustment: Both-sided
- Overall Dimensions : 390 × 200 × h400 mm
- Net Weight approx. : 9 kg

STANDARD



OPTION



<L1>

Cat. No.	Tube	Eyepiece	Objectives Quality	Objectives	Price (₩)
KE.OBN.135	Trinocular	HWF 10×/φ20mm	Infinity Plan	4× / 10× / 20× / 40× / 100×	2,692,450

Optional Accessories

KE.OBB.A1237 Phase Contrast unit with 10× / 20× / 40× / 100× Infinity-PH-Plan Objectives Set, Included PH Rotary Condenser

Ea. Price, ₩
3,041,120

Kern® High Quality Fluorescence Microscope “OBN-14”, Fluorescence Refracted Light Unit with Power Supply, 40× ~ 1000× **NEW**
 With 20W Halogen illumination Unit and 100W EPI Fluorescence Incident illumination Unit, 고성능 형광 현미경

■ Supplied by Kern® in Germany

NEW

3-Year Warranty



illumination Unit



Sextuple Filter Wheel OBN 148

PROFESSIONAL LINE

The Fluorescence Microscope for the Professional User

Features

- The Fluorescence Microscope in the OBN-14 Series is Based on the Usual High Quality and Versatility of the OBN Series. the outstanding, Stable Design in Combination with High-quality Optics Set the Standard in Fluorescence Microscopy in this Class
- The Powerful, Dimmable 20W Halogen illumination Unit (Philips) and a 100W Epi Fluorescence Incident illumination Unit on the OBN 148 Models Ensure Perfect illumination and Stimulation of your Fluorescence Samples
- This Series has a Professional Koehler illumination Unit with an Adjustable Field Diaphragm as Well as a Height-Adjustable 1.25 Abbe Condenser which can be Centered and which has an Adjustable Aperture Diaphragm
- The Extremely Large Mechanical Stage with Ergonomic, Coaxial Coarse and Fine Focusing Knob on Both Sides Enables you to Adjust and Focus your Sample Rapidly and Accurately
- With the OBN 148 Halogen Variant you have a Filter Wheel which has Up to 6 Fittings. as Standard this is Fitted with a B/G/UV/V Fluorescence Filter. the Changeover Slider and the Filter Wheel Mean that you can Change the Stimulation Filter Quickly
- A Large Selection of Eyepieces, Objectives, Color Filters, Darkfield Condensers as Well as a Butterfly Tube, Polarizing and Phase Contrast Units can Easily be Integrated Thanks to the Modular Construction System
- The Centering Objective for Adjusting the Fluorescence, a Protective Dust Cover, Eye Cups as Well as Multi-lingual User Instructions are Included in the Scope of Delivery

Technical Data & Applications

- Haematology, Urology, Gynaecology, Dermatology, Pathology, Microbiology and Parasitology, Immunology, Sewage Treatment Plants, oncology, Entomology, Vets, Water analysis and Breweries
- Specially for Translucent, Thin, Low-contrast, Challenging Samples (e.g. Immunofluorescence, FISH, DAPI Staining, etc.)
- Infinity Optical System
- Quintuple Nosepiece
- Siedentopf 30° Inclined / 360° Rotatable
- Diopter Adjustment : Both-sided
- Overall Dimensions 530 × 220 × h490 mm
- Net Weight Approx. 23 kg

STANDARD



OPTION



<L1>

Cat. No.	Tube	Eyepiece	Objectives Quality	Objectives	Price (₩)
KE.OBN.148	Trinocular	HWF 10×/φ20mm	Infinity Plan	4×/ 10×/ 20×/ 40×/ 100×	10,905,350

Kern® Inverted Biological Laboratory Microscope “OCM”, for Cell/Tissue Culture, Large Working Distance of 72mm, 100× ~ 400× / 200× PH With 30W Halogen illumination Unit and 100W EPI Fluorescence illumination Unit, 독립 생물 현미경 **NEW**

■ Supplied by Kern® in Germany



N.A. 0,3 Abbe Condenser with Phase Contrast Slide



Coaxial Control Knobs for x/y can be Fitted Either Left or Right

PROFESSIONAL LINE

The Inverted Biological Laboratory Microscope – also with Fluorescence

Features

- The OCM Range Stands out Through its Design which is Ergonomic, Robust and Extremely Stable. this Design, with its Large Working Distance, is Particularly Suitable for the Monitoring and analysis of Cell Cultures, for Example.
- A Strong and Continuously Adjustable 30W Halogen illumination Unit Ensures the Optimum illumination in the Bright Field of your Samples. an Additional Osram 100 W Epi Fluorescence illumination Unit is Available to you as a Fluorescence Microscope (OCM 165) for Perfect illumination and Excitation of your Fluorescence Samples
- A Special Abbe N.A. 0.3 Condenser with Aperture Diaphragm and Large Working Distance of 72 mm Guarantees the Very Best Working Practise in the Bright Field and with Fluorescence Applications
- As Standard, the OCM Range is Fitted with a Trinocular Eyepiece Tube
- The Mechanical Stage Including Specimen Holder (ϕ 118 mm) Means that you can Work Quickly and Effectively. Further Brackets for Petri Dishes are Included with Delivery or Available as Accessories
- Further Options such as, for Example, a Selection of Eyepieces, Objectives, Specimen Holders and Other Phase Contrast Units can be Integrated as Accessories
- A Dust Cover as Well as User Instructions are Included with the Delivery

Technical Data & Applications

- Research and Breeding of Cell Cultures and Tissue Cultures
- Particularly for Viewing Samples in Culture Vessels (Flasks, Petri Dishes, Microtitre Plates), Translucent, Thin, Low-contrast, Challenging Samples (e.g. Living Mammal Cells, Tissue, Microorganisms If Necessary, Immunofluorescence, FISH, DAPI Staining Etc.)
- Infinity Optical System
- Quintuple Nosepiece
- Siedentopf 45° Inclined
- Diopter Adjustment : Both-sided
- Overall Dimensions 304 × 599 × h530mm (OCM 161), 304 × 782 × h530mm(OCM 165)
- Net Weight Approx. 13.5 kg(OCM 161), Approx. 21 kg(OCM 165)

STANDARD



<L1>

Cat. No.	Tube	Eyepiece	Objectives	illumination	Price (₩)
KE.OCM.161	Trinocular	HWF 10×/φ22mm	LWD10×/LWD20×/ LWD40×/LWD20×PH	30W Halogen (transmitted)	6,159,690
KE.OCM.165				30W Halogen, 100W Epi Fluorescence (B/G)	15,089,270

Kern® Fully-equipped Metallurgical Microscopes “OKO”, for Testing Metals and Analyzing Surface, 50× ~ 500× **NEW**
 With Refracted and Transmitted LED illumination, Height-adjustable 1.25 Abbe Condenser, 고성능 금속 현미경

■ Supplied by Kern® in Germany



Stage OKO



illumination Unit

PROFESSIONAL LINE MET

The Fully-equipped Refracted and Transmitted Light Microscope for Numerous Applications in Metallurgy

Features

- This Device is a Professional, Versatile, Metallurgical Microscope, which is Used in Testing Metals and Analysing Surfaces
- The KERN OKO 178 is a Combi Variant of LED Incident illumination and LED Transmitted illumination. A Height-adjustable 1.25 Abbe Condenser which can be Centred as Well as a Field Diaphragm for Complete Professional Köhler illumination are Part of the Standard Version.
- An Open, Mechanical Angle Table is Integrated as Standard
- A Simple Polarising Unit (analyser and Polariser) is Included with Delivery
- A Large Selection of Accessories, such as, for Example, Eyepieces and Further

- Objectives are Available for Longer Working Distances
- A Protective Dust Cover, Eye Cups, as Well as Multi-lingual User Instructions are Included in the Scope of Delivery
- A C-Mount Adapter is Required to Connect a Camera. You can Select this Adapter from the Following Model Outfit List
- Please Find Detailed Information in the Following Model Outfit List

Technical Data & Applications

Technical

- Infinity Optical System
- Quintuple Nosepiece
- Siedentopf 30° Inclined/360° Rotatable
- Diopter Adjustment : Both-sided
- Overall Dimensions 550 × 200 × h460 mm
- Net Weight Basic Configuration Approx. 14.5 kg

Scope of Application

- Metallurgy, Material Testing, Quality Assurance

Applications/Samples

- Opaque and Thick Samples, Workpieces (Surfaces, Fold Lines, Coatings)

STANDARD



Cat. No.	Tube	Eyepiece	Objectives Quality	Objectives	illumination	Price (₩)
KE.OKO.178	Trinocular	HWF 10×/φ22mm	Infinity Plan	5×/ 10×/ 20×/ 50×	5W LED (Incident + Transmitted)	5,404,250

<L1>

Kern® Metallurgical Inverted Microscope “OLM”, Adjustable 50W Halogen illumination, 50× ~ 500× NEW
 Suitable for Surface Quality Testing of Raw Materials and Finished Products, 고성능 금속 도립 현미경

■ Supplied by Kern® in Germany



LAB LINE MET

The Inverted Metallurgical Microscope for Professional Applications

Features

- The KERN OLM Range is Part of the Range of Inverted Microscopes and Stands out Through its Design which is Ergonomic, Robust and Extremely Stable. this Range, with its Large Working Distance is, for Example, Particularly Suitable for Surface Quality Testing of Raw Materials and Finished Products in Industry
- Strong and Continuously Adjustable 50W Halogen illumination Unit Ensures the Optimum illumination of the Materials to be Tested
- As Standard, the OLM Range is Fitted with a Trinocular Eyepiece Tube
- A Simple Polarizing Unit (Analyzer and Polarizer) is included with Delivery
- A Large Mechanical Stage is Included with Delivery as Standard. the Coarse and Fine Focusing Knob on Both Sides Guarantees Optimal Adjustment and Focusing
- Further Options Such As, for Example, a Large Selection of Objectives can be Integrated as Accessories
- A Dust Cover as Well as User Instructions are Included with the Delivery

Technical Data & Applications

- Metallurgy, Material Testing, Quality Assurance
- Opaque and Thick Samples, Workpieces (Surfaces, Fold Lines, Coatings)
- Infinity Optical System
- Quintuple Nosepiece
- Siedentopf 30° Inclined
- Mechanical Stage w210 × d180mm
- illumination 50W Halogen Spare Bulb (Incident)
- Diopter Adjustment : Both-sided
- Overall Dimensions 271 × 379 × h747 mm
- Net Weight Approx. 12.5 kg

STANDARD



<L1>

Cat. No.	Tube	Eyepiece	Objectives Quality	Objectives	Price (₩)
KE.OLM.171	Trinocular	HSWF10×/φ22mm	Infinity plan	LWD5×/LWD10×/LWD20×/LWD50×	6,179,060

Articles	Cat. No	Description
----------	---------	-------------

Kern® High-quality Phase Contrast Microscope “OBL-14”, Pre-centred Phase Contrast Condenser with Aperture Diaphragm, 40× ~ 1000× With 20W Halogen illumination, PH10×/ PH40× Objectives, 1.25 Abbe Condenser, Large Mechanical Stage, 위상차 생물 현미경 **NEW**

■ Supplied by Kern® in Germany



Mounted Phase Contrast Condenser



Simple PH Condenser with 40× PH Slide

LAB LINE

High-quality Phase Contrast Microscope – Specially Pre-configured with a Series of Options for Flexible Expansion

Features

- We have developed this Series Specially for General Applications with Phase Contrast Method. In addition, the Stable, Modular Construction System of the OBL Series Offers Many More Options
- A Strong and Continuously Adjustable 20W Halogen illumination Unit (Philips) Ensures the Optimum Lighting Conditions
- A Special Fixed, Pre-centred Phase Contrast Condenser with Aperture Diaphragm as well as Field Diaphragm Give you a Simplified Koehler illumination and Thereby a Powerful Phase-contrast Display of your Sample
- The Large Mechanical Stage and its Specimen Holder Holds up to two Samples at the Same Time and is Quick and Easy to Focus Using a Coaxial Coarse and Fine Focusing Knob on both Sides

- A Large Selection of Eyepieces, Objectives and Color Filters, a Simple Polarising Unit as well as Further Phase Contrast Units are Available to you as Accessories
- A Protective Dust Cover, Eye Cups, as well as Multi-lingual User Instructions are Included in the Scope of Delivery

Technical Data & Applications

- Haematology, Urology, Gynaecology, Dermatology, Pathology, Microbiology and Parasitology, Immunology, Sewage Treatment Plants, Oncology, Entomology, Vets, Water Analysis and Breweries
- Specially for Extremely Translucent, Thin, Low-contrast, Challenging Samples (e.g. Living Mammal Cells, Bacteria, tissue) with Phase Contrast
- Infinity Optical System
- 20 W Halogen Spare Bulb (Transmitted)
- Quadplex Nosepiece
- Siedentopf 30° Inclined / 360° Rotatable
- Diopter Adjustment : One-sided
- Overall Dimensions : 395×200×h380 mm
- Net Weight approx. : 6.7 kg

STANDARD



OPTION



<L1>

Cat. No.	Tube	Eyepiece	Objectives Quality	Objectives	Price (₩)
KE.OBL.145	Binocular	HWF 10×/φ 20mm	Infinity E-Plan/Plan	4×/ pH10×/ pH40×/ 100×	2,750,560
KE.OBL.155	Trinocular	HWF 10×/φ 20mm	Infinity E-Plan/Plan	4×/ pH10×/ pH40×/ 100×	2,963,630

Optional Accessories

KE.OBB.A1549 Trinocular Tube

Ea. Price, ₩
| 677,970 |

Kern® Powerful Polarizing Microscope “OPM”, with Height-adjustable Swing-out Abbe Condenser, 40× ~ 400× NEW With Complete Koehler illumination, Built-in Center-adjustable Bertrand Lens, 고성능 편광 현미경

■ Supplied by Kern® in Germany

NEW

3-Year
Warranty



Bertrand lens, λ Slip, 360° rotatable analyser (removable)



Center-adjustable and turnable polarisation stage

PROFESSIONAL LINE POL

The Flexible and Powerful Polarizing Microscope for all Professional Applications with Reflected and Transmitted Light

Features

- These Devices are Professional, Fully-equipped Polarizing Microscopes, which Use the Polarization of Light to Analyze Minerals, Crystals and Isotropic Materials
- A Complete Koehler illumination is Integrated into OPM as Standard
- As Standard, the KERN OPM Transmitted illumination Variants Have a Height-adjustable 0,9/0,13 Swing-out Abbe Condenser which can be Centered, for Complete Koehler illumination
- A 360° Revolving Stage with 1° Division, 6' Fine Division and Locking Function is Integrated into all Series as Standard
- As Standard all Series are Fitted with a Complete Polarizing Unit with Scale, a Bertrand Lens, a $\lambda + \frac{1}{4}\lambda$ Slip as Well as a Quartz Wedge

- A Large Selection of Accessories such as, for Example, a Mechanical Stage Attachment as Well as Further Objectives for a Long Working Distance and Filter Units are also Available
- A Protective Dust Cover, Eye Cups, as Well as Multi-lingual User Instructions are Included in the Scope of Delivery
- A C-Mount Adapter is Required to Connect a Camera.

Technical Data & Applications

- Mineralogy, Texture Observations, Material Testing, Observation of Crystals
- More Complex Samples with Polarizing Properties
- Infinity Optical System
- Quintuple Nosepiece
- Siedentopf 30° Inclined
- Analyzer Unit with Scale : 360° Rotatable, Lockable
- Bertrand Lens : Built-in, Center-adjustable
- Swing-out Condenser : N.A. 0,9 / 0,13 Swing-out Achromatic Condenser (Aperture Diaphragm)
- illumination : 20W Halogen (Transmitted)
- Diopter Adjustment : One-sided
- Overall Dimensions 500×200×h500 mm
- Net Weight Approx. 14.5 kg

STANDARD



<L1>

Cat. No.	Tube	Eyepiece	Objectives Quality	Objectives	Price (₩)
KE.OPM.181	Trinocular	WF 10×/φ20mm	Infinity Plan	Non-stress 4×/10×/20×/40×	6,643,950

Articles	Cat. No	Description
----------	---------	-------------

Kern® Small Educational Stereomicroscope “OSE-4”, Fixed Eyepieces, Robust & Stable, 20×, 40× NEW
 With Pillar Style Stand with 0.21 W LED illumination, Frosted Glass/Black-White Stage Plate, **교육용 실체 현미경**

■ Supplied by Kern® in Germany



EDUCATIONAL LINE

The Small Robust Model for School, Training Establishment or Workshops

Features

- The KERN OSE-4 is an Extremely Robust, Stable Stereo Microscope which is Easy to Use, it is Ideal for all Conventional Applications in Schools, Workshops and Training Companies
- Depending on the Model, Optional LED Reflected illumination as Well as Transmitted and Reflected illumination Ensure the Very Best illumination of your Sample
- A Turnable Objective with Predefined Magnifications is Available to Make your Working Procedures Quicker and More Efficient
- The Eyepieces are Fixed in the Eyepiece Tube, to Stop them Getting Damaged or Lost
- A Protective Dust Cover, Eye Cups, as Well as Multi-lingual User Instructions are Included in the Scope of Delivery

Technical Data & Applications

- Training, in Vitro Fertilization, Detection of Parasites, Zoology and Botany, Tissue Preparation, Section, Quality Control
- Samples with Focus on Three-dimensional Impression (depth, Thickness), e.g. Insects, Seeds, Circuit Boards, Components
- Optical System : Greenough Optics
- Tube 45° Inclined
- Interpupillary Distance 55 - 75 mm
- Working Distance 57mm
- Field of View ϕ 10 mm(2×), ϕ 5 mm(4×)
- Stage Plate : Frosted Glass / ϕ 95 mm, Black-White / ϕ 95 mm
- Diopter Adjustment : one-sided
- Overall Dimensions 230 × 130 × h330 mm
- Net Weight Approx. 2 kg

STANDARD



Cat. No.	Tube	Eyepiece	Objectives	Stand	illumination	Price (₩)
KE.OSE.417	Binocular	WF 10×/φ20mm	2×/4×	Pillar Style	0.21W LED (Incident/Transmitted)	493,960

Kern® Mobile Stereomicroscope “OSE-42”, Rechargeable Battery, 20×, 40× NEW
 Integrated Handle with Stable Arm Curved Stand, 1 W LED illumination, Frosted Glass/Black-White Stage Plate, **교육용 실체 현미경**

■ Supplied by Kern® in Germany



EDUCATIONAL LINE

Stereo Microscope with Robust, Ergonomic Design, Ideal for Workshops, Schools and Training

Features

- With its Integrated Handle as Well as its Stable Arm Curved Stand, the KERN OSE-42 has been Specially Developed for Schools and Workshops
- The Incident and Transmitted illumination Unit Included as Standard can be Optionally Enabled for the Very best illumination of your Sample. Mobile Use of the OSE 422 is also No Problem Through the Use of Rechargeable Batteries
- A Turnable Objective with Predefined Magnifications is Available to Make your Working Procedures Quicker and More Efficient
- The Eyepieces are Fixed in the Eyepiece Tube, to Stop them Getting Damaged or Lost
- A Special Feature of this Adaptable and Yet Robust Microscope Series is the Stable Mechanism of the Microscope Stand which can be Adjusted Precisely. it Will also Impress you with its Functionality and Ergonomic Design

Technical Data & Applications

- Training, in Vitro Fertilisation, Detection of Parasites, Zoology and Botany, Tissue Preparation, Section, Quality Control
- Samples with Focus on Three-dimensional Impression(depth, Thickness), e.g. Insects, Seeds, Circuit Boards, Components
- Brightness Adjustable
- Tube 45° Inclined
- Interpupillary Distance 55 - 75 mm
- Working Distance 57mm
- Field of View ϕ 10 mm(2×), ϕ 5 mm(4×)
- Stage Plate : Frosted Glass / ϕ 59.5 mm, Black-White / ϕ 59.5 mm
- Diopter Adjustment : Both-sided
- Overall Dimensions 200 × 180 × h300 mm
- Net Weight Approx. 2 kg

STANDARD



Cat. No.	Tube	Eyepiece	Objectives	Stand	illumination	Price (₩)
KE.OSE.422	Binocular	WF 10×/φ20mm	2×/4×	Arm Curved	1W LED (Incident/Transmitted) (Rechargeable Batteries Included)	513,340

Kern® All-rounder Stereo Zoom Microscope “OZL-46”, 3W LED Transmitted/Reflected illumination, 7× ~ 45× NEW
 With Standard Stand, Binocular & Trinocular, Pillar Style Stand, Frosted Glass/Black-White Stage Plate, 연구용 실체 현미경

■ Supplied by Kern® in Germany



LAB LINE

The Flexible, Affordable All-rounder with Zoom Function for Schools, Training Companies, Inspection Authorities and Laboratories

Features

- The Products in the KERN OZL-46 Series are Stereo Zoom Microscopes, which will Impress you with their Quality, Easy Handling, Flexibility as Well as their Stability and Economical Price
- The LED Reflected and Transmitted illumination Included as Standard Guarantees the Very Best illumination of your Sample
- As Well as Excellent Optical Characteristics and their Large Working Surface, these Models offer the Highest Level of Comfort in this Class—ideal for Training Companies, Workshops as Well as Assembly and Repair Workstations, e.g. in the Electronics industry
- The Zoom Objective offers you Continuous Magnification From 7×–45×
- The KERN OZL-46 Series is Available as a Binocular or Trinocular Version
- A Protective Dust Cover, Eye Cups, as Well as Multi lingual User instructions are included in the Scope of Delivery
- A C-mount Adapter is Required to Connect a Camera to the Trinocular Version.

Technical Data & Applications

- In Vitro Fertilization, Detection of Parasites, Zoology and Botany, Tissue Preparation, Section, Quality Control
- Samples with Focus on Three-dimensional Impression, Zoom with Variable Magnification (Depth, Thickness), e.g. Insects, Seeds, Circuit Boards, Components
- Brightness Adjustable (Separate)
- Tube 45° inclined / • Magnification Ratio : 6.4:1
- Light Distribution 50 : 50
- Interpupillary Distance 55 - 75 mm
- Working Distance 105mm
- Maximum Sample Height 140mm
- Stage Plate : Frosted Glass / φ95 mm, Black-White / φ95 mm
- Diopter Adjustment : Both-sided
- Overall Dimensions 300×240×h420 mm
- Net Weight Approx. 4 kg

STANDARD



<L1>

Cat. No.	Tube	Eyepiece	Field of View	Objective Zoom	Stand	illumination	Price (₩)
KE.OZL.463	Binocular	HWF 10× φ20mm	φ28.6 - 4.4	0.7× ~ 4.5×	Pillar style	3W LED (incident/Transmitted)	968,510
KE.OZL.464	Trinocular	HWF 10× φ20mm	φ28.6 - 4.4	0.7× ~ 4.5×	Pillar style	3W LED (incident/Transmitted)	1,104,120

Kern® Excellent Stereo Zoom Microscope “OZM”, First-class Optic & Strong illumination, 7× ~ 45× NEW
 With Dimmable 3 W LED Reflected and Transmitted illumination, Frosted Glass/Black-White Stage Plate, 고성능 연구용 실체 현미경

■ Supplied by Kern® in Germany



LAB LINE

First-class Optics and Strong illumination Combined with a High Level of Flexibility

Features

- The KERN OZM Series is a Range of Excellent Stereo Zoom Microscopes with Above-average Optical Features
- The Ergonomic Shape Allows a Simple, Effortless Working Over a Period of Several Hours
- The Extraordinarily Strong and Continuously Dimmable 3 W LED Reflected and Transmitted illumination Ensures a Flexible and Particularly Good Level of illumination for your Sample
- With its Large Working Distance, an Extra Large Field of View and its Brilliant Resolution, the KERN OZM Provides Sharp, High-contrast, Color-true Images
- The Zoom Objective Gives you Continuous Magnification From 7,5×–45×
- The Pillar Stand is Particularly Flexible due to its Variable and Sturdy Adjustment Mechanism and therefore Enables Ergonomic Working Procedures

Technical Data & Applications

- In Vitro Fertilization, Detection of Parasites, Zoology and Botany, Tissue Preparation, Section, Quality Control, Electronics and Semiconductor industry, Assembly and Repair
- Samples with Focus on Three-dimensional Impression, Zoom with Variable Magnification (Depth, Thickness), e.g. Insects, Seeds, Circuit Boards, Components
- Brightness Adjustable (Separate)
- Tube 45° Inclined / • Magnification Ratio : 6.4 : 1
- Light Distribution OZM 543 / 544 : 50 : 50
- Interpupillary Distance 52 - 76 mm
- Working Distance 110mm
- Maximum Sample Height 130mm
- Stage Plate : Frosted Glass / φ94.5 mm, Black-White / φ94.5 mm
- LED illumination 3W (Transmitted), 3W (Incident)
- Diopter Adjustment : Both-sided
- Overall Dimensions 330×285×h440 mm
- Net Weight Approx. 4.5 kg

STANDARD



<L1>

Cat. No.	Tube	Eyepiece	Field of View	Objective Zoom	Stand	illumination	Price (₩)
KE.OZM.542	Binocular	HSWF10x/φ23mm	φ32.8~5.1	0.7× ~ 4.5×	Pillar Style	3W LED (incident/transmitted)	2,072,610

Articles	Cat. No	Description
----------	---------	-------------

Kern® High-performance Stereo Zoom Microscope “OZP”, Large Magnification Range, 6× ~ 55× NEW
 With Adjustable 3 W LED Reflected and Transmitted illumination, Binocular/Trinocular, **고배율 연구용 실체 현미경**

■ Supplied by Kern® in Germany



NEW

3-Year Warranty

LAB LINE

Professional and Powerful – Thanks to its Extremely Large Magnification Range, Strong illumination and First-class Optics

Features

- The KERN OZP Stereo Zoom Microscope Stands out Through its Above-average Magnification Range and its Robust Shape which is Also Ergonomic, it Enables Effortless, Simple Working Over a Period of Several Hours
- The KERN OZP Series is Available as a Strong, Continuously Adjustable 3 W LED Reflected and Transmitted Light Variant for the Very Best illumination of your Sample or as a Variant without illumination
- With its Large Working Distance, an Extra Large Field of View and Brilliant Resolution, the KERN OZP Provides Sharp, High-contrast and Color-true Images
- There is a Choice of a Binocular Model as Well as a Trinocular Model for Connecting a Camera for Documentation Purposes and for Quality Reports
- The Pillar Stand is Particularly Flexible due to its Variable and Sturdy Adjustment Mechanism and therefore Enables Ergonomic Working Procedures
- A C-mount Adapter is Required to Connect a Camera to the Trinocular Version.

Technical Data & Applications

- Zoology and Botany, Quality Control, Electronics and Semiconductor industry, Assembly and Repair
- Samples with Focus on Three-dimensional Impression, Zoom with Variable Magnification(Depth, Thickness), e.g. Insects, Seeds, Circuit Boards, Components
- Optical System: Greenough Optics
- Brightness Adjustable (Separate)
- Tube: 35° Inclined / • Magnification Ratio : 9.2 : 1
- Light Distribution OZP 557 / 558 : 50 : 50
- Interpupillary Distance 52 - 76 mm
- Working Distance 108mm
- Maximum Sample Height 110mm
- Stage Plate : Frosted Glass / φ94.5 mm, Black-White / φ94.5 mm
- LED illumination 3W (Transmitted), 3W(Incident)
- Diopter Adjustment : Both-sided
- Overall Dimensions 330×285×h470 mm
- Net Weight Approx. 4.5 kg

STANDARD



Cat. No.	Tube	Eyepiece	Field of View	Objective Zoom	Stand	illumination	Price (₩)
KE.OZP.556	Binocular	HSWF10×/φ23mm	φ38.3~4.2	0.6× ~ 5.5 ×	Pillar Style	3W LED (incident/Transmitted)	2,382,530
KE.OZP.558	Trinocular	HSWF10×/φ23mm	φ38.3~4.2	0.6× ~ 5.5 ×	Pillar Style	3W LED (incident/Transmitted)	2,963,630

Kern® Professional Trinocular Stereo Zoom Microscope “OZR”, with Parallel Optics System, 8× ~ 50× NEW
 With Pillar Style Stand, 3 W LED Reflected and Transmitted illumination, **전문가용 실체 현미경**

■ Supplied by Kern® in Germany



NEW

3-Year Warranty

PROFESSIONAL LINE

Professional Stereo Zoom Microscope with Parallel Optics for Excellent Images, Depth of Field, Contrast and Fatigue-free Working

Features

- The KERN OZR Series is a Special, High-quality Stereo Zoom Microscope with Parallel Optics for Demanding Analyses
- The Parallel Optical System is a High-quality Optical System and Provides Excellent Images with the Best Contrast, Colour and Depth of Field with Fatigue-free Working. Refocusing is also Only Necessary in Very Few Cases when Magnifying the Zoom
- The Continuously Adjustable Magnification Range From 8 to 50 Times Magnification Means That you Can Work Quickly and Effectively
- As Standard, the Models of the KERN OZR Series are Trinocular and are therefore Equipped for Connecting a Camera for Documentation Purposes and for Quality Reports
- The Pillar Stand is Particularly Flexible Due to its Variable and Sturdy Adjustment Mechanism and therefore Enables Ergonomic Working Procedures
- A C-mount Adapter is Required to Connect a Camera to the Trinocular Version.

Technical Data & Applications

- In Vitro Fertilization, Detection of Parasites, Zoology and Botany, Tissue Preparation, Section, Quality Control, Electronics and Semi conductor Industry, Assembly and Repair
- Samples with Focus on Three-dimensional Impression, Zoom with Variable Magnification(Depth, Thickness), e.g. Insects, Seeds, Circuit Boards, Components
- Optical System : Parallel Optics
- Brightness Adjustable (separate)
- Tube 45° Inclined / • Magnification Ratio : 6.25 : 1
- Light Distribution 50 : 50
- Interpupillary Distance 52 - 76 mm
- Working Distance 91mm
- Maximum Sample Height 100mm
- Stage Plate : Frosted Glass / φ94.5 mm, Black-White / φ94.5 mm
- LED illumination 3W (Transmitted), 3W(Incident)
- Diopter Adjustment : Both-sided
- Overall Dimensions 305×300×h540 mm
- Net Weight Approx. 5.5 kg

STANDARD



Cat. No.	Tube	Eyepiece	Field of View	Objective Zoom	Stand	illumination	Price (₩)
KE.OZR.564	Trinocular	HWF10×/φ22mm	φ27.5~4.4	0.8× ~ 5 ×	Pillar Style	3W LED (incident/Transmitted)	3,389,770

Kern® Microscope Cameras, "ODC", 3,1 & 5,1 Mega-pixel, CMOS, USB Connection NEW

Including Software & USB-output for Easy Connection to the Microscope · PC, 현미경 카메라

■ Supplied by Kern® in Germany

NEW



ODC 825



USB Cable with Micrometer Slide



C-mount Adapter

Features

- These Microscope Cameras are Universal and can be Easily Connected to the Microscope and a PC / Laptop via USB.
- The Proven CMOS Technology Provides Fast, Clear Images.
- The Attached English-language Software Provides a Good Basis for Observing, Measuring and Documenting Your Work in all Common Microscopy Applications.
- The Camera, USB Cable, Software CD and a Stage Micrometer for Calibration are Included in the Scope of Delivery.
- Additional Models are Available on Request or by Going to www.kern-sohn.com on the Internet

Note!

This product have to use with "C-mount Adapter"

STANDARD



<L1>

Cat. No.	Resolution	USB	Sensor	Sensor Size	Colour / Monochrome	Supported Operating System	Price (₩)
KE.ODC.824	3,1 MP	2.0	CMOS	1/2"	Colour	Win XP, Vista, 7, 8, 10	716,710
KE.ODC.825	5,1 MP	2.0	CMOS	1/2.5"	Colour	Win XP, Vista, 7, 8, 10	745,760

Necessary Accessories

KE.OBB.A1142 C-mount Camera Adapter 1.00×
 KE.OBB.A1515 0.50×

Ea. Price, ₩
187,850
358,360

Articles

Cat. No

Description



Digital Wood Moisture Meter, "AR 971", 2~70%, 54×27×h150mm, 210g **NEW**

디지털 목재 수분계, 넓은 측정 범위

■ 휴대하기 편리한 디자인, 넓은 측정범위, 전원 자동 차단 기능

- * Measurement Range : 2 ~ 70%
- * Resolution : 0.5%
- * Accuracy : ±2%
- * Function : Data Hold, Auto Power Off
- * Power Supply : 9V Battery
- * Excluding Battery
- * Operating Temperature : 0°C~40°C

<L2>

SL.Met3961 "AR 971", Meter, Wood Moisture Measurement, 54×27×h150mm, 210g

Pk.	Price, ₩
	166,100



Humidity Indicator Paper, for Humidity Detection, RH 10~60% **NEW**

Reaction Humidity : 6-points, RoHs Supported, Reversibility, Blue→Pink, 수분 측정지

■ 습색 상태로 습도판정-수분이 많으면 청색에서 분홍색으로 변하여 표시되며 습도의 범위는 6단계로 세분화됨

- * It can Determine Humidity of Color Over 12hours after Putting.
- * Not Suitable for Place Where Humidity Change a lot at Short Time
- * Accuracy : ±5%RH(at 25°C)
- * Discoloration : Blue→Pink
- * Dimensions : 1Sheet: L34×w121mm
- * Package : 200 Sheets/Pk.

<L2>

SL.Lab9121 Humidity Indicator Paper, 10~60%RH, ±5%RH

Pk.	Price, ₩
200sheet	214,940

Articles

Cat. No

Description

NEW



Amos[®] White Craft Glue, High Quality Liquid Glue, Washable, Odorless, 36 · 74 · 120g **NEW**
 Ideal for Wood · Fabric · Craft Paper, Dry Clear, 목공용 접착제

■ 다양한 용도 ; 다양한 범위에서 사용 가능한 접착제

- * Broad Precise Application * Apply to Clean & Dry Surfaces
- * Two-way Tips : Wide for Large Areas & Narrow for Precise Application

- A5.1007 Adhesive, White Craft Glue, 36g
- A5.1008 , 74g
- A5.1009 , 120g

<B4>

Ea.	Price, ₩	Cs.	Price, ₩
	620	10ea	
	1,120	10ea	
	1,740	10ea	



NEW

3M[®] Scotch[®] 2g · 4g · 7g · 20g Quick dry Super Glue-gel, in Safety Vessel
 Good for Small Gaps, for Ceramic · Glass · Leather · Metal · Rubber · Wood, 강력 순간접착제

- * Solvent-Free, No-Tips. * Cyano Acryl Resin Based.
- * Quick drying Super Strength Adhesive Designed for a Wide Variety of Surfaces.

<B4>

(1) 2g "AD122" Super Glue Gel, with Safety Vessel, 초강력 타입

3M.02.1009 Scotch[®] "AD122" Super Glue-gel, 2g

Pk.	Price, ₩	Cs.	Price, ₩
1ea	2,420	12pk	

(2) 4g "AD124-G" Super Glue Gel, Clog-resistant, 막힘방지 타입 **NEW**

3M.02.1026 Scotch[®] "AD124-G" Super Glue-gel, 4g

Pk.	Price, ₩	Cs.	Price, ₩
1ea	4,150	12pk	

(3) 7g "AD127" Brush-type Super Glue-Liquid, with Safety Vessel, 브러쉬 타입

3M.02.1011 Scotch[®] "AD127" Brush type Super Glue Liquid, 7g

Pk.	Price, ₩	Cs.	Price, ₩
1ea	2,360	10pk	

(4) 20g "AD120" Twist Cap type Super Glue-Liquid, 트위스트캡 타입

* Not Blacked Hole, Adjustable Volume.

3M.02.1012 Scotch[®] "AD120" Twist Cap type Super Glue Liquid, 20g

Pk.	Price, ₩	Cs.	Price, ₩
1ea	3,040	12pk	

(1) 2g "AD122"









(2) 4g "AD124-G"



(3) 7g "AD127"



(4) 20g "AD120"

Articles	Cat. No	Description								
		3M® Command™ Multipurpose Hook, Excellent Bonding, Damage-Free Hanging, Reusable NEW Ideal for Hang Home Décor, Cleaning Tools, and Other Small Items, 다용도 후크, 접착식								
(1) (2) (3)		<ul style="list-style-type: none"> ■ 거실, 주방, 공부방 등 다양한 장소에서 주변정리에 도움을 줌 ■ 못질 자국이나 잔사가 남지 않음 - 혁신적인 테이프 기술력으로 강력하게 붙고, 표면 손상 없이 깨끗하게 떼어낼 수 있음 * Can be Reused with Command® Refill Tapes * Easy to Apply and Remove * Excellent Bonding to Help Hold Items Securely * Hang Freely Without the Need for Tools or Other Equipment * Leaves Behind No Holes, Marks, or Sticky Residue 								
		Round Hook, Limit Load 300g~1.8kg, 라운드 후크								
(4) (5) (6)		<table border="1"> <thead> <tr> <th>Pk. Price, ₩</th> <th>Cs. Price, ₩</th> </tr> </thead> <tbody> <tr> <td>3M.02.17402 (1) Round Hook, Small, 22mm × 40mm, Limit Load 300g, 3 Hooks</td> <td>3ea 1,800 12pk</td> </tr> <tr> <td>3M.02.17401 (2), Medium, 22mm × 70mm, Limit Load 900g, 2 Hooks</td> <td>2ea 1,800 12pk</td> </tr> <tr> <td>3M.02.17403 (3), Large, 28mm × 95mm, Limit Load 1.8kg, 1 Hooks</td> <td>1ea 1,800 12pk</td> </tr> </tbody> </table>	Pk. Price, ₩	Cs. Price, ₩	3M.02.17402 (1) Round Hook, Small, 22mm × 40mm, Limit Load 300g, 3 Hooks	3ea 1,800 12pk	3M.02.17401 (2), Medium, 22mm × 70mm, Limit Load 900g, 2 Hooks	2ea 1,800 12pk	3M.02.17403 (3), Large, 28mm × 95mm, Limit Load 1.8kg, 1 Hooks	1ea 1,800 12pk
Pk. Price, ₩	Cs. Price, ₩									
3M.02.17402 (1) Round Hook, Small, 22mm × 40mm, Limit Load 300g, 3 Hooks	3ea 1,800 12pk									
3M.02.17401 (2), Medium, 22mm × 70mm, Limit Load 900g, 2 Hooks	2ea 1,800 12pk									
3M.02.17403 (3), Large, 28mm × 95mm, Limit Load 1.8kg, 1 Hooks	1ea 1,800 12pk									
		Utility Hook, Limit Load 300g~1.8kg, 유틸리티 후크								
(7) (8) (9)		<table border="1"> <thead> <tr> <th>Pk. Price, ₩</th> <th>Cs. Price, ₩</th> </tr> </thead> <tbody> <tr> <td>3M.02.17502 (4) Utility Hook, Small, 16mm × 30mm, Limit Load 300g, 3 Hooks</td> <td>3ea 1,800 12pk</td> </tr> <tr> <td>3M.02.17501 (5), Medium, 18mm × 55mm, Limit Load 900g, 2 Hooks</td> <td>2ea 1,800 12pk</td> </tr> <tr> <td>3M.02.17503 (6), Large, 22mm × 80mm, Limit Load 1.8kg, 1 Hooks</td> <td>1ea 1,800 12pk</td> </tr> </tbody> </table>	Pk. Price, ₩	Cs. Price, ₩	3M.02.17502 (4) Utility Hook, Small, 16mm × 30mm, Limit Load 300g, 3 Hooks	3ea 1,800 12pk	3M.02.17501 (5), Medium, 18mm × 55mm, Limit Load 900g, 2 Hooks	2ea 1,800 12pk	3M.02.17503 (6), Large, 22mm × 80mm, Limit Load 1.8kg, 1 Hooks	1ea 1,800 12pk
Pk. Price, ₩	Cs. Price, ₩									
3M.02.17502 (4) Utility Hook, Small, 16mm × 30mm, Limit Load 300g, 3 Hooks	3ea 1,800 12pk									
3M.02.17501 (5), Medium, 18mm × 55mm, Limit Load 900g, 2 Hooks	2ea 1,800 12pk									
3M.02.17503 (6), Large, 22mm × 80mm, Limit Load 1.8kg, 1 Hooks	1ea 1,800 12pk									
		Spare Accessories								
(10) (11) (12)		<table border="1"> <thead> <tr> <th>Pk. Price, ₩</th> <th>Cs. Price, ₩</th> </tr> </thead> <tbody> <tr> <td>3M.02.17024S (7) Refill Tape, White, 16mm × 46mm, 10 Sheets</td> <td>10ea 1,320 20pk</td> </tr> <tr> <td>3M.02.17024M (8), 15mm × 70mm, 6 Sheets</td> <td>6ea 1,320 20pk</td> </tr> <tr> <td>3M.02.17024L (9), 20mm × 95mm, 4 Sheets</td> <td>4ea 1,530 12pk</td> </tr> </tbody> </table>	Pk. Price, ₩	Cs. Price, ₩	3M.02.17024S (7) Refill Tape, White, 16mm × 46mm, 10 Sheets	10ea 1,320 20pk	3M.02.17024M (8), 15mm × 70mm, 6 Sheets	6ea 1,320 20pk	3M.02.17024L (9), 20mm × 95mm, 4 Sheets	4ea 1,530 12pk
Pk. Price, ₩	Cs. Price, ₩									
3M.02.17024S (7) Refill Tape, White, 16mm × 46mm, 10 Sheets	10ea 1,320 20pk									
3M.02.17024M (8), 15mm × 70mm, 6 Sheets	6ea 1,320 20pk									
3M.02.17024L (9), 20mm × 95mm, 4 Sheets	4ea 1,530 12pk									
		3M® Command™ Clear Cord Clips, Damage-Free Hanging, Reusable NEW Ideal for Keep Cords Organized, Easy to Apply and Remove, 전선 정리용 클립, 접착식								
(13) (14)		<ul style="list-style-type: none"> ■ 다양한 표면에 강력하게 부착되어 전선 등을 깔끔하게 정리 ■ 구멍을 남기거나, 잔사를 남기지 않고 깨끗하게 제거 가능 * Available Cord Thickness : (1) Aprx. 10mm (2) Aprx. 12mm * Come off Cleanly - No Holes, Marks, Sticky Residue or Stains * Holds Strongly and Removes Cleanly <B4> * Can be Reused with Command™ Refill Tapes 								
		<table border="1"> <thead> <tr> <th>Pk. Price, ₩</th> <th>Cs. Price, ₩</th> </tr> </thead> <tbody> <tr> <td>3M.02.17301 (1) Cord Clips, Clear, 33mm × 18mm, 4 Clips + 4 Tapes, Medium</td> <td>4ea 3,800 6pk</td> </tr> <tr> <td>3M.02.17303 (2), 55mm × 23mm, 2 Clips + 2 Tapes, Large</td> <td>2ea 3,800 6pk</td> </tr> </tbody> </table>	Pk. Price, ₩	Cs. Price, ₩	3M.02.17301 (1) Cord Clips, Clear, 33mm × 18mm, 4 Clips + 4 Tapes, Medium	4ea 3,800 6pk	3M.02.17303 (2), 55mm × 23mm, 2 Clips + 2 Tapes, Large	2ea 3,800 6pk		
Pk. Price, ₩	Cs. Price, ₩									
3M.02.17301 (1) Cord Clips, Clear, 33mm × 18mm, 4 Clips + 4 Tapes, Medium	4ea 3,800 6pk									
3M.02.17303 (2), 55mm × 23mm, 2 Clips + 2 Tapes, Large	2ea 3,800 6pk									
		3M® Command™ Holding Hook, Broom Gripper, Damage Free Hanging NEW Ideal for Storing Broom Sticks, Fast & Easy to Hang, 막대걸레 후크, 접착식								
(15)		<ul style="list-style-type: none"> ■ 막대걸레를 깔끔하게 보관가능 * Good for Neatly Storing Brooms * Weight Capacity : 1.8kg * Can be Reused with Command™ Refill Tapes 								
		<table border="1"> <thead> <tr> <th>Pk. Price, ₩</th> <th>Cs. Price, ₩</th> </tr> </thead> <tbody> <tr> <td>3M.02.17007 Hook, for Broom, 1 Hook + 2 Large Tapes</td> <td>1ea 4,560 12pk</td> </tr> </tbody> </table>	Pk. Price, ₩	Cs. Price, ₩	3M.02.17007 Hook, for Broom, 1 Hook + 2 Large Tapes	1ea 4,560 12pk				
Pk. Price, ₩	Cs. Price, ₩									
3M.02.17007 Hook, for Broom, 1 Hook + 2 Large Tapes	1ea 4,560 12pk									
		3M® Command™ Metal Hook for Bathroom, with Water Resistant Strips NEW Ideal for Bathroom Organization, Ideal for Bathroom Organization, 메탈후크, 욕실용, 접착식								
(16)		<ul style="list-style-type: none"> ■ 습기가 많은 욕실에서도 강력하게 부착가능 ■ Made of Satin Nickel * Good for Hanging Towels, Robes, Loofahs, or Any Other Bath Stuffs * Sticks to a Variety of Surfaces Including Glass, Mirror, Tile, Fiberglass * Good Work on Wet, Hot and Humid Conditions * Strong & Versatile * Can be Reused with Command™ Refill Tapes 								
		<table border="1"> <thead> <tr> <th>Pk. Price, ₩</th> <th>Cs. Price, ₩</th> </tr> </thead> <tbody> <tr> <td>3M.02.17008 Hook, for Bathroom, Metal, 110mm × 35mm, 1 Hook + 2 Large Tapes</td> <td>1ea 8,420 12pk</td> </tr> </tbody> </table>	Pk. Price, ₩	Cs. Price, ₩	3M.02.17008 Hook, for Bathroom, Metal, 110mm × 35mm, 1 Hook + 2 Large Tapes	1ea 8,420 12pk				
Pk. Price, ₩	Cs. Price, ₩									
3M.02.17008 Hook, for Bathroom, Metal, 110mm × 35mm, 1 Hook + 2 Large Tapes	1ea 8,420 12pk									
		3M® Command™ Picture & Frame Hanging Strips, Holds Strongly, Removes Cleanly NEW Ideal for Detachable Stuffs, Easy to Use, 부착테이프								
(17)		<ul style="list-style-type: none"> ■ 테이프와 찍찍이 테이프가 결합되어 주로 액자나 탈부착을 자주하는 상품을 부착하는데 편리함 ■ 벽면 손상 없이 깔끔하게 정리 정돈할 수 있음 * Come off Cleanly - No Nail Holes, Cracked Plaster or Sticky Residue * No Tools Required - No Need to Nails and Screws 								
		<table border="1"> <thead> <tr> <th>Pk. Price, ₩</th> <th>Cs. Price, ₩</th> </tr> </thead> <tbody> <tr> <td>3M.02.17205 Hanging Strips, Small, 1.5cm × 3.5cm, Limit Load 450g, 8 Set</td> <td>8set 3,390 6pk</td> </tr> <tr> <td>3M.02.17204, Medium, 2cm × 5cm, Limit Load 1kg, 6 Set</td> <td>6set 3,800 6pk</td> </tr> <tr> <td>3M.02.17203, Mixed, Small 4 set + Medium 6 Set</td> <td>10set 5,110 6pk</td> </tr> </tbody> </table>	Pk. Price, ₩	Cs. Price, ₩	3M.02.17205 Hanging Strips, Small, 1.5cm × 3.5cm, Limit Load 450g, 8 Set	8set 3,390 6pk	3M.02.17204, Medium, 2cm × 5cm, Limit Load 1kg, 6 Set	6set 3,800 6pk	3M.02.17203, Mixed, Small 4 set + Medium 6 Set	10set 5,110 6pk
Pk. Price, ₩	Cs. Price, ₩									
3M.02.17205 Hanging Strips, Small, 1.5cm × 3.5cm, Limit Load 450g, 8 Set	8set 3,390 6pk									
3M.02.17204, Medium, 2cm × 5cm, Limit Load 1kg, 6 Set	6set 3,800 6pk									
3M.02.17203, Mixed, Small 4 set + Medium 6 Set	10set 5,110 6pk									

Articles	Cat. No	Description
		Komelon® Cutter & Blade, High Performance, Durable, Excellent Cutting, 커터와 날, 고성능 NEW
		<ul style="list-style-type: none"> ■ Made in Korea * They have a excellent quality * Firm and Smooth Button Operation * Strong and Sharp SK2Cr4 Blade * Stainless-steel Guide for Rust Resistance and Strong Hardness * Safe Cutting * High Strength Stainless Steel Guide
		<B4>
		(1) Slim Blade Cutter with 9mm Wide Blade
	DH.Off3091 (a)	Slim Blade Cutter, L153mm, 32g
	DH.Off3092 (b)	, L145mm, 40g
		(2) Large Blade Cutter with 18mm Wide Blade
	DH.Off3093 (c)	Large Blade Cutter, L160mm, 122g
	DH.Off3094 (d)	, L167mm, 96g
		(3) X-Large Blade Cutter with 25mm Wide Blade
	DH.Off3095 (e)	X-Large Blade Cutter, L193mm, 166g
	DH.Off3096 (f)	, L193mm, 163g
		Optional Accessories
	DH.Off3097 (g)	Blade, Slim, 9×L 80mm Wide Blade, 10ea/pk
	DH.Off3098 (h)	, Large, 18×L100mm Wide Blade, 10ea/pk
	DH.Off3099 (i)	, X-Large, 25×L126mm Wide Blade, 10ea/pk

Pk.	Price, ₩	Cs.	Price, ₩
1ea	3,880	10pk	35,840
1ea	4,130	10pk	38,080

Pk.	Price, ₩	Cs.	Price, ₩
1ea	6,330	10pk	58,520
1ea	5,810	10pk	53,630

Pk.	Price, ₩	Cs.	Price, ₩
1ea	11,350	6pk	63,000
1ea	7,990	6pk	44,360

Pk.	Price, ₩	Cs.	Price, ₩
10ea	1,150	10pk	10,510
10ea	2,160	10pk	19,880
10ea	8,900	10pk	82,320



PVC Non-Slip Cutting Mat, Excellent for Self-Recovery, with Grid Line, Durable, 2.75mm Thick Ideal for Protect Work Surface & Blade, PVC 논슬립 커팅 매트 NEW

- 칼자국을 스스로 회복하는 자체 복원력 우수
- Suitable for All Kinds of Writing, Craft Paper Carving, Cutting, etc.
- * Protect Table-top From Scratches Caused by Sharp Tools or Glue
- * Help Cutting More Convenient and Smooth

<B4>

DH.Off3005	Cutting Mat, PVC, Thick 2.75mm, 300×215mm	Ea.	Price, ₩	Pk.	Price, ₩
DH.Off3006	, 450×300mm		2,820	10ea	27,230
DH.Off3007	, 620×450mm		5,390	10ea	52,230
DH.Off3008	, 900×620mm		10,430	30ea	303,330
			20,400	10ea	197,790

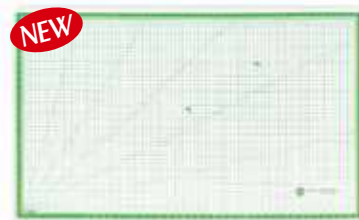

PP Non-Slip Cutting Mat, with 5×5mm Grid and 15°·30°·45°·65°·75°·90° Angle Marking Excellent Self-Resilience, Protect Work Surface and Blade, 440×300mm, Thick 2mm, 논슬립 커팅 매트 NEW

- 4층 구조(4 Layers) : EVA PP - Homo PP - Homo PP - EVA PP
- EVA PP 재질(Material) : 미끄럼 방지(Non-Slip) 및 자체 복원력(Self-Resilience) 우수
- 5×5mm 의 격자무늬 와 15°·30°·45°·65°·75°·90° 각도가 표시되어 커팅 작업에 최적화
- * 3 Color will be Delivered Randomly (Black, Green, Yellow)

<B1>

DH.Off3009	Cutting Mat, PP, Non-Slip, 440×300mm, Thick 2mm	Ea.	Price, ₩
			7,640

Articles	Cat. No	Description
----------	---------	-------------

NEW



A4 D-Ring Binder, PVC, Document Storage, Thickness 3.5~7.5cm **NEW**
 Ideal for Organize the documents, A4 3공 D링 바인더

- Made in Korea
- 관공서에서 사용되고 있는 정부문서파일
- 내부 스토퍼 기능으로 서류의 찢어짐을 방지함
- 겉면에 PVC 포켓이 있어 앞, 뒷면 표지 사용이 용이함

DH.Off2001	Binder, White, A4(200sheet), 310×260×t35mm
DH.Off2002	, A4(300sheet), 310×270×t55mm
DH.Off2003	, A4(400sheet), 310×280×t75mm

<B4>

Pk.	Price, ₩
	4,910
	5,260
	5,600

Clip Board, PS, Transparent, 클립 보드 **NEW**



* Available for Hanging Pen
 * Max. 30 Sheets

DH.Off2021 Clip Board, Transparent, A4

<B4>

Pk.	Price, ₩
1ea	2,320

A4 Clip Board for Confirmation, 결재화일 **NEW**



■ 결재용 서류 보관함

DH.Off2036 Clip Board, PVC, A4, Black

<B4>

Ea.	Price, ₩
	2,040

A4 Clear File with Sliding Bar, 5 Colors **NEW**
 Ideal for Hold the documents, 레일클리어 홀더



* Max. 60 Sheets

DH.Off2031 File, Clear, A4, 230×310mm, Blue
 DH.Off2032 , Clear
 DH.Off2033 , Green
 DH.Off2034 , Red
 DH.Off2035 , Yellow

<B4>

Pk.	Price, ₩
10ea	7,000
10ea	7,000
10ea	7,000
10ea	7,000
10ea	7,000

Holder File, Transparent **NEW**
 Ideal for Filing Documents, L자 투명 홀더 파일



■ Made in Korea

DH.Off2022 Holder File, Transparent, A4, Blue
 DH.Off2023 , Clear
 DH.Off2024 , Green
 DH.Off2025 , Red
 DH.Off2026 , Yellow

<B4>

Pk.	Price, ₩
10ea	1,900
10ea	1,900
10ea	1,900
10ea	1,900
10ea	1,900



File Holder Box, Reusable **NEW**
 Ideal for Classify Document, 파일박스, 서류보관함

- * Good for Classify Documents, Paper file, etc.
 - * Max. 11,000 Sheets
- DH.Off2041 File Holder Box, 320×250×100mm, Blue
 DH.Off2042 , 320×250×100mm, Green
 DH.Off2043 , 320×250×100mm, Red
 DH.Off2044 , 320×250×100mm, White

<B4>

Ea.	Price, ₩
	920
	920
	920
	920

NEW



(1) 2-layer (3) 4-layer

PP Desk Drawer Cabinet, Multi-layer Classification Storage, w260×d195mm, h15~29cm
 Durable, Suitable for Storing, Practical, 2~4단 서랍식 캐비닛, 서류정리함 **NEW**

- 뛰어난 내구성의 PP소재, 넉넉한 수납공간; 각종 서류, 문구, 생활 잡동사니 수납가능
- Ideal for Storing Documents and Organizing Office Supplies
- * Made of Polypropylene * Easy to Use * Safe and Odorless * Good for Storing
- * Keep Desk Clean and Tidy

DH.Dra3011	(1) Drawer, PP, 2-layer, w260×d195×h153mm, 605g
DH.Dra3012	(2) , 3-layer, w260×d195×h223mm, 845g
DH.Dra3013	(3) , 4-layer, w260×d195×h290mm, 1090g

<B1>

Ea.	Price, ₩
	18,340
	24,440
	30,560

Articles

Cat. No

Description



Wooden Book Stand, Multi-use, Ideal for Holding Books, 나무 받침대, 노트북 & 책 지지용 NEW

- * Durable
- * Coil Spring Clips can Hold Papers
- * Adjustable Angle
- * Useful for Home, Office & School

DH.Off3011 Wooden Book Stand, 302×213×h42mm, Small
DH.Off3012 , 336×232×h42mm, Medium
DH.Off3013 , 407×265×h42mm, Large



<B4>

Ea.	Price, ₩
	14,900
	17,580
	21,400

Adjustable Angle



3M® Laptop Stand, Durable, Ergonomic Design NEW

Provide Comfortable Viewing Height, Non-Skid, 노트북용 받침대

- 목, 허리와 손목의 긴장을 풀어주고 바른자세를 유도하도록 인체공학적으로 설계됨
- Position Laptop Screen at an Ergonomically Correct Height while Taking up Less Desk Space.
- * Raise Screen Height to Reduce Neck Strain
- * Suitable for Use in Office or Home Desk



<B4>

3M.02.LS85B (1) Stand, for Laptop, 259×264×158cm, 1.8kg
3M.02.LX550 (2) , 209×203×241cm

Pk.	Price, ₩	Cs.	Price, ₩
1ea	29,570		
1ea	17,920	4pk	



Wooden Monitor Stand, Durable, Multi-function, w50×d20cm, Height 8 & 12cm NEW

Ideal for Organize the Desk, Prevent Neck & Shoulder Pain, 모니터 받침대, 1단 & 2단

- 효율적인 공간활용 - 좁은 책상을 넓게 사용 가능
- Brings Monitor Up to Eye Level to Promote Better Posture
- * Made of Wood
- * Suitable for Use in Office or Home Desk
- * Can Make the Desk more Tidy and Organized
- * Storage Space for Keyboard, Mouse, Pens, and Other Small Office Supplies

<B1>

DH.Off6001 (1) Stand, for Monitor, w50×d20×h8cm
DH.Off6002 (2) , 2 Shelf, w50×d20×h12cm

Ea.	Price, ₩
	24,300
	30,400

Storage Space



3M® Precise™ Mouse Pad, with Repositionable Adhesive NEW

Portable, Ultra-thin, 휴대용 재부착 마우스 패드

- 여러 번 떼고 붙일 수 있고, 휴대가 편리함
- * Surface Enhances the Precision of Optical Mouse at Fast Speeds
- * Battery Saving Design Extends Battery Life of Wireless Mice up to 50%

<B4>

3M.02.MP200PS Mouse Pad, Portable, 177×215×76mm

Pk.	Price, ₩
1ea	6,770



3M® Copy Holder, Sleek Design, with Height Adjustable Clip, Holds 35 Sheets NEW

Easy to Detachable, Lightweight, 문서 고정용 클립, 모니터 탈부착가능

- 작은 메모지부터 A4용지까지 문서 크기에 맞게 길이 조절이 가능
- 회전고리를 이용하여 모니터 좌/우측 구분 없이 장착 가능
- * Sheet Capacity : 35 Sheets
- * Documents can be Viewed Portrait and Landscape

<B4>

3M.02.DH445 Holder for Document, 228×254×7cm, max.35 sheets, 220g

Ea.	Price, ₩	Cs.	Price, ₩
	9,660	6ea	

Articles		Cat. No	Description								
	LED 레이저 포인터 다국적 Laser Point (LED Light)			LED 라이트 CHINA LED Pen Light							
 사용동영상	 NEW		 NEW	 NEW							
<ul style="list-style-type: none"> ■ 강력한 LED 라이트 ■ 국제규격 CE인증 레이저포인터 ■ 수은건전지 3개 내장 	<B3>	<ul style="list-style-type: none"> ■ 밝기 : 20 루멘 ■ 발광다이오드 LED 적용 ■ 줌기능 ■ 원터치 전원버튼 ■ 포켓 클립 장착 ■ 배터리 별도; AAA×2 	<B3>	<ul style="list-style-type: none"> ■ 3단계 밝기모드 ■ 최대 밝기 : 400루멘 ■ 사용시간 : 최대 13시간 ■ 보조배터리 기능 ■ 분리가능한 접이식 나이프 ■ KC 인증 충전식 건전지 내장 	<B3>						
ORDER NO.	MODEL NO.	PRICE, ₩ Ea.	포장단위 Ea. / Pk.	ORDER NO.	MODEL NO.	PRICE, ₩ Ea.	포장단위 Ea. / Pk.	ORDER NO.	MODEL NO.	PRICE, ₩ Ea.	포장단위 Ea. / Pk.
0432-659	TU211	10,080	1 / 6	0309-618	WS-0428	4,710	1 / 24	0519-143	NE6715	31,920	1 / 12



LED Desk Lamp with Stable Light, Flicker Free, Adjustable Brightness Up to 1300Lux **NEW**
With Adjustable Head & Body, Anti-Glare, LED 데스크 램프

- 5단계 밝기 조절과 2단계 각도 조절 기능이 있는 LED 스탠드 * Eliminates Multiple Shadow and Prevents Disruption to Reading
- * Provide Uniform, Soft, and Flicker Free Light : Minimize Eye Fatigue
- * Brightness Level Stage : 5 Level * Adjustable Head & Body : Free Angle Control
- * Color Temperature : Daylight(5500K) * Power Supply : AC 240V, 8W

DH.Lam3001 LED Desk Lamp, 8W, 180×315×h420mm, 700g, White
DH.Lam3002 , Black

Ea.	Price, ₩
	32,630
	32,630



USB Rechargeable LED Stand with Flicker Free, Adjustable Brightness Up to 300Lux **NEW**
With Adjustable Head, Anti-Glare, USB Rechargeable Battery, USB 충전형 LED 스탠드

- 3단계 밝기 조절과 각도 조절 기능이 있는 이동식 충전형 LED 스탠드
- * Provide Uniform, Soft, and Flicker Free Light : Minimize Eye Fatigue
- * Brightness Level Stage : 3 Level * Adjustable Head Free Angle
- * Usage Time : 5hr(1Level), 4hr(2Level), 3hr(3Level) * Full Charging Time : 3hr
- * 3.7V 1200mAh Rechargeable Battery * Power Supply : 5V, 1A USB Cable 1m (Included)

DH.Lam3021 USB Rechargeable LED Stand, 80×100×h270mm, 300g, White

Ea.	Price, ₩
	16,800



Removable LED Wall Sconce Light with on-off Switch, Daylight **NEW**
Ideal for Bedroom, Stairs, Hallway, Restroom, 벽등, 콘센트 부착형

- 은은한 조명으로 침실, 복도, 계단에 고정형으로 사용 * Used by Attaching to Power Receptacle
- * Easy Operation with on-off Switch * Color Temperature : Daylight * Small Size Simple Design
- * Long Life without Lamp Replacement * Power Supply : AC 250V, 1W

DH.Lam3026 Removable LED Wall Sconce Light, 40×45×107mm, 50g

Ea.	Price, ₩
	2,400

Articles

Cat. No

Description



Magnet Tape with Dispenser, with Adhesive Side and Magnetic Side, w19mm × L3m NEW
Easy and Quick Removal and Repositioning, 마그넷 테이프, 디스펜서형

■ 자석 부착이 가능한 모든 곳에 사용가능(Multiuse) : 프리저(Freezer), 후드(Hood), 인큐베이터(Incubator), etc <B1>
* Dispenser Size : 100×75mm * Tape : w19mm×L3m

DH.Tap3011 Magnet Tape, with Dispenser, w19mm×L3m

Ea.	Price, ₩
	3,060



3M® Scotch® “372KS” Box Packing Tape, Transparent & Translucent Milky-Amber NEW
Ideal for High Strength Packaging, Solvent-type, Durable, w48 × 50m, 박스포장용 테이프, 보급형

■ 초기 접착력 우수, 모서리 찢김 저항성 ■ Solvent-type Acrylic Adhesive Coated Tape <B4>
* High Edge Tear and Split Resistance * Excellent Tensile Strength

3M.08.372KS.C “372KS” Box Tape, 48mm×L50m, Clear
3M.08.372KS.A , Milky-Amber

Pk.	Price, ₩	Cs.	Price, ₩
1roll	1,110	50pk	
1roll	1,110	50pk	



3M® Scotch® “3615R-6” Packing Tape, Transparent & Translucent Milky-Amber NEW
With Water Based Acrylic Adhesive Coated, Odorless, 0.065mm-thick., w48 × 50m, 박스 테이프, 고급형

■ 찢어짐이나 변형이 없는 강력한 접착력, 수용성 아크릴 접착제로 인체에 덜 유해함 <B4>
■ Water Based Acrylic Adhesive Coated Tape : Strong Adhesion / Long Life / Good Water Resistance
* High Strength, Flexible, Odorless, Multipurpose and an Excellent Packing Function

3M.02.6103 (1) “3615R-6” Box Tape, 5-roll/Pk, 48mm×L50m, Clear
3M.02.6104 (2) , Milky-Amber

Pk.	Price, ₩	Cs.	Price, ₩
6ea	14,490	10pk	
6ea	14,490	10pk	



Antimicrobial Copper-Mixed PE Film, Anti-Virus, w30cm, L1.5 & 2m NEW
With Double Side Tape for Attaching, Non-Adhesive, 항균 필름, 양면 테이프 포함

■ 순도 높은 구리가 혼합(Mixed Copper) 된 PE 필름으로 항균력이 뛰어남
■ 비접착형(Non-Adhesive) : 양면테이프 동봉(Double Side Tape) - 5×15mm
* Ideal for High-Touch Surface * Copper Prevent Spreading of Virus
* DH.Fil3101 is ideal for Flat Surface * DH.Fil3102 is ideal for Rough Surface <B1>

DH.Fil3101 Antimicrobial Film, Copper-Mixed PE, w30cm×L1.5m
DH.Fil3102 , w30cm×L2m

Pk.	Price, ₩
1ea	3,060
1ea	4,600

, Paper 페이퍼



(1) Clean Paper

Clean Room Paper & Clean Room Note, Class 1000 NEW
Ideal for Clean Room Use, Minimize Particle Generation by Special Coating, 크린룸용 페이퍼 & 크린노트

■ 정전기 방지 * Improves Surface Smoothness to Prohibit Paper Jam
* Anti-static : Copying Paper, Minimize Dust and Static Electricity <L1>

(1) Clean Room Paper

DH.Pap9001 Clean Room Paper, A3, Sky Blue, 250sheet
DH.Pap9002 , A4, Sky Blue, 250sheet
DH.Pap9003 , White, 250sheet
DH.Pap9004 , Pink, 250sheet
DH.Pap9005 , Yellow, 250sheet
DH.Pap9006 , A5, Sky Blue, 250sheet

Pk.	Price, ₩	Cs.	Price, ₩
250sheet	21,030	5pk	102,010
250sheet	10,650	10pk	103,290
250sheet	10,650	10pk	103,290
250sheet	10,940	10pk	106,110
250sheet	10,940	10pk	106,110
250sheet	5,330	20pk	103,290

(2) Clean Room Note

DH.Not9001 Clean Room Note, A4, Spring, 50sheet
DH.Not9002 , A5, Spring, 50sheet
DH.Not9003 , A6, Spring, 50sheet

Pk.	Price, ₩	Cs.	Price, ₩
50sheet	5,610	5pk	28,000
50sheet	3,630	5pk	16,810
50sheet	2,970	10pk	27,360



(2) Clean Notebook

Articles	Cat. No	Description
----------	---------	-------------

Zetstream® Permanent Ballpoint Pen, 0.38 & 0.5mm Tip NEW

Black · Blue · Red, 유성볼펜



* Soft with Good Grip

		<B4>	
		Ea.	Price, ₩
DH.Off1001	Pen, 0.38mm, Black		1,380
DH.Off1002	, Blue		1,380
DH.Off1003	, Red		1,380
DH.Off1005	Pen, 0.5mm, Black		1,380
DH.Off1006	, Blue		1,380
DH.Off1007	, Red		1,380

Monami® Water-based Plus Pen, Odorless, 0.2mm Fine Tip NEW

For Underline / Writing, Quick Drying, 수성 플러스 펜



* Smooth Writing
* Consistent Ink Flow
* Good for Underline, Writing

		<B4>	
		Ea. Price, ₩	Pk. Price, ₩
M9.A03853	Plus Pen, water-based, Black	260	12ea
M9.A03854	, Blue	260	12ea
M9.A03855	, Red	260	12ea

Pentel® Ain® Eraser, Easy to Erase, 지우개 NEW



* Less Abrasion and Dust Enable Longer Use and Keep the Desk Clean

		<B4>	
		Ea.	Price, ₩
DH.Off3015	Eraser, 43 × 18 × 12mm, Small		620
DH.Off3016	, 65 × 26 × 13mm, Medium		920

Zetstream® Tricolor Permanent Ballpoint Pen, 0.5 & 0.7mm Tip NEW



* Useful for Home, Office & School

		<B4>	
		Ea.	Price, ₩
DH.Off1011	(1) Pen, Tricolor, 0.5mm, White		4,600
DH.Off1012	(2) , 0.7mm, Clear		4,600



Board Cleaner Set, 100ml, 보드 크리너 NEW

■ 오염된 화이트보드 표면을 깨끗하게 닦아냄. 전용 천과 세트로 구성됨
* Good for Cleaning Board Surface

DH.Off3021 Cleaner, for White Board, 100ml

		<B4>	
		Ea. Price, ₩	Pk. Price, ₩
		1,920	12ea

Punches 펀치 & Fasteners 책철

SUNKEY 자동 센터펀치, Auto Center Punch TAIWAN



■ 금긋기 용구의 일종 ■ 비트 최고급 합금강 S2 재질로 내구성이 우수
■ 내부에 스프링이 장치되어 있어 손쉽게 마감

ORDER NO.	MODEL NO.	규격	PRICE, ₩ Ea.	포장단위 Ea. / Pk.
0414-774	SOP-130	중	9,020	1 / 12
0414-775	SOP-160	대	10,660	1 / 12



Binding String, Made of Spun Polyester, with Plastic Tip, L70cm NEW

■ Made in Korea
* 서류를 철하거나 보관할 때 사용
* 끝부분이 플라스틱 팁으로 특수처리 되어있어 풀리지 않음

		<B4>	
		Pk.	Price, ₩
DH.Off2061	Binding String, L70cm	18ea	1,610

Articles

Cat. No

Description



Whashin® Office Stamp, General & Liquid-type, <Korea-made>, 사무용 스탬프 <B4>

(1) General Stamp, Red Color, One-touch Open

W1.ST50 General Stamp, Red, 115×100×t 29mm

Pk.	Price, ₩	Cs.	Price, ₩
1ea	3,110	12pk	34,380

(2) Liquid Stamp, Red · Blue · Black

* The Liquid is Absorbed Sponge Pad Easy to Use.

W1.ST01 Stamp, Red, 118×79×t 25mm

W1.ST02 , Blue, 118×79×t 25mm

W1.ST03 , Black, 118×79×t 25mm

Pk.	Price, ₩	Cs.	Price, ₩
1ea	1,990	12pk	22,000
1ea	1,990	12pk	22,000
1ea	1,990	12pk	22,000

(3) Ink for Liquid Stamp, Red · Blue · Black NEW

DH.Off3027 Ink, Red

DH.Off3028 , Blue

DH.Off3029 , Black

Pk.	Price, ₩	Cs.	Price, ₩
1ea	2,040	12pk	23,720
1ea	2,040	12pk	23,720
1ea	2,040	12pk	23,720



, Staplers 스테플러

Peace® Office Stapler NEW
Trouble-free, 사무용 스테플러

■ Made in Korea

* These staplers are designed for those who perform a large of stapling

* These staplers are designed for those who perform a large of stapling

* Trouble-free Operation is Possible.

* It has been acquired from the accumulated know-how by manufacturing staplers in past 30years and up-to-date facilities.



(1) Small-type Stapler <B4>

DH.Off3031 ① Small Stapler, Loading of 50pcs.

W1.010(No.10 Staple) Avail.,
20×95×h43mm

DH.Off3032 ② Small Stapler, Loading of 100pcs.

W1.033(No.33 Staple) Avail.,
21×120×h49mm

Pk.	Price, ₩
1ea	3,200
1ea	5,100



(2) Medium-type Stapler

DH.Off3033 ③ Medium Stapler, Loading of 100pcs.

W1.033(No.33 Staple) Avail.,
35×123×h50mm

DH.Off3034 ④ Medium Stapler, Loading of 100pcs.

W1.033(No.33 Staple) Avail.,
33×137×h60mm

Pk.	Price, ₩
1ea	5,740
1ea	7,640



(3) Large-type Stapler

DH.Off3035 ⑤ Large Stapler, Loading of 200pcs.

W1.033(No.33 Staple) Avail.,
42×196×h61mm

DH.Off3036 ⑥ Large Stapler, Loading of 200pcs.

W1.033(No.33 Staple) Avail.,
40×180×h60mm

Pk.	Price, ₩
1ea	9,560
1ea	10,200



(4) Binding-type Stapler

* DH.Off3037 : 200 Sheet Avail. W1.H1308~H1324 Avail., 93×380×h265mm

* DH.Off3038 : Long Arm Stapler, 784g, Loading of 200pcs.,
W1.033(No.33 Staple) Avail., 45×405×h78mm

DH.Off3037 ⑦ Binding Stapler, 1801g

DH.Off3038 ⑧ Long Arm Stapler, 784g

Pk.	Price, ₩
1ea	44,560
1ea	25,460

(5) Multiuse Gun Tacker

DH.Off3039 ⑨ Tacker, 567g, Loading of 200pcs. 200 Sheet Avail.

W1.H1308~H1310 & W1.R1308 Avail.,
34×176×h115mm

Pk.	Price, ₩
1ea	21,640

Articles	Cat. No	Description
----------	---------	-------------

SI Analytics® Digital One-channel Multi-parameter Meter, “Lab 875” & “Lab 875P” NEW
 With IDS Sensor, Safe Determination of pH, ORP, Conductivity and Dissolved Oxygen, <Germany-made>, 디지털 멀티미터



“Lab 875” Multi-parameter Meter



“Lab 875P” Multi-parameter Meter, Built-in Printer

- “Lab 875” and “Lab 875P”-Model ■ Automatic Sensor Recognition
 - Optimized Measurements and Efficient Documentation in the Simplest Manner.
 - CMC(Continuous Measurement Control) and QSC (Sensor Quality Control)
 - Optically Installed Thermal Printer : Lab 875P
 - Process Signals in the Sensor Digitally so that Precise and Interference-free Measurements are enabled even with Long Cables.
- * Automatic, Digital Capture of all Sensor Data.
 * User Administration Capabilities for the Safe Allocation of User and Measuring Results.
 * Transmission of all Data in “.csv” format via USB Interface to PC.
 * Output Directly to an Optional Integrated Printer - Lab 875P

Parameter	pH, mV, Conductivity, Spec. Resistance, Salinity, TDS, Temperature
Calibration Points	pH (1~5 points), D.O. (1 point), Conductivity (1 point)
Calibration Timer	1~999 days
Memory	Manual 500 Data Sets, Automatic 4,500 Data Sets
Interface	Mini USB-B
Display	Graphic, BW
Power Supply	Universal Power Supply(100~240V, 50/60Hz Power pack), 4 × 1.5 V AA Batteries
Type of Protection	IP 43
Dimensions	Lab 875 - w230 × d190 × h80 mm Lab 875P - w290 × d190 × h80 mm
Weight	Lab 875 - Approx. 0.8kg, Lab 875P - Apprx. 1.0kg

Ordering Information

Cat. No.	Type No.	Description	Ea. Price, ₩
SG.285206320	Lab 875	Digital Multi-meter Lab 875 without Sensor	2,116,040
SG.285206330	Lab 875P	Digital Multi-meter with Printer Lab 875P without Sensor	2,927,530

Accessory

Cat. No.	Type No.	Description	Ea. Price, ₩
SG.285202440	FDO 1100 IDS	Optical Oxygen Sensor, Temp. sensor NTC30kOhm, 1.5m Cable with Plug	1,822,260
SG.285206370	Z 610	Printer paper for Lab 875P, 1 Roll	40,870

SI Analytics® Digital High-performance Multi-parameter Meter Set, “ProLab 2500” NEW
 With 3 Channel IDS Sensor – pH · Cond. · D.O., Color Digital Display, Antibacterial Keyboard Cover, <Germany-made>, 고성능 디지털 멀티미터



“ProLab 2500” Multi-parameter Meter Set

- “ProLab 2500”- Model ■ Antibacterial Keyboard
 - Three Universal Measuring Channels ■ Digital Sensor Recognition
 - Measuring pH, ORP, ISE, D.O., and Conductivity
 - QSC (Quality Sensor Control) Icon provide Precise Information about the actual State of the Electrode.
- * Automatic, Digital Capture of All Sensor Data for Retraceability of Measured Values.
 * Data output to PC, USB memory stick or selected Printers. * Memory with 10,000 possible entries.

Parameter	pH, mV, Conductivity, Spec. Resistance, Salinity, TDS, Temperature
Calibration Points	pH (1~5 points), ISE(2~7, requires adapter), D.O. (1 point), Conductivity (1 point)
Calibration Timer	1~999 days
Memory	Manual 500 Data Sets, Automatic 10,000 Data Sets
Interface	USB-A, Mini USB-B
Display	Color Graphic
Power Supply	Universal Power Supply(100~240V, 50/60Hz Power pack), 4 × 1.5 V AA Batteries

Ordering Information

Cat. No.	Type No.	Description	Ea. Price, ₩
SG.285206790	ProLab 2500 pH/Cond/Ox set	Digital Multi-meter ProLab 2500 with A162 IDS pH Sensor, LF 413T IDS Cond Sensor and FDO 1100 IDS DO Sensor	7,858,080
SG.285202440	FDO 1100 IDS	Optical Oxygen Sensor, Temp. sensor NTC30kOhm, 1.5m Cable with Plug	1,822,260



Mini Portable Heat Sealer, with Safety Cover, 50g NEW
 For Various Plastic Films Package, Magnetic-Design for Easy Storage, White, 미니 휴대용 열선 실링기

- 작은 사이즈에 작동이 편리한 가열접합 열선방식 비닐 밀봉기
- 바닥 면에 자석이 붙어있어 냉장고에 붙여서 보관 가능
- * Sealer is suited for Various Plastic Films Package
- * Magnet Hidden at the Bottom, which can be adsorbed on the Refrigerator for Easy Storage
- AA건전지 2개 별도구매
- * Dust- & Moisture-Proof

DH.Pac3001 Mini Portable Heat Sealer, 10×4×2.7cm, 50g

<B1>

Ea.	Price, ₩
	15,280

PP밴드 조임기 & 결속기, PP Band Strapping Tensioner & Sealer KOREA

(1) 조임기

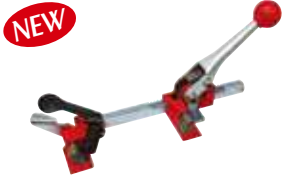

사용동영상

<B3>

ORDER NO.	MODEL NO.	PRICE, ₩ Ea.	사용규격(mm)	포장단위 Ea. / Cs.
0300-761	PST-100	45,080	13~19	1 / 10

(2) 결속기



- 클립을 이용하여 P.P 밴드를 결속할 수 있는 제품

ORDER NO.	MODEL NO.	PRICE, ₩ Ea.	사용규격(mm)	포장단위 Ea. / Cs.
0300-763	PSE-16	24,800	16	1 / 20
0300-762	PSE-19	24,800	19	1 / 20

PS밴드 조임기 & 결속기, PS Band Strapping Tensioner & Sealer KOREA

(1) 조임기



- 원치형 플라스틱밴드 조임기로서 WINDLASS SHAFT를 이용하여 조이는 방식으로 절단기가 부착된 것이 특징

<B3>

ORDER NO.	MODEL NO.	PRICE, ₩ Ea.	사용규격(mm)	포장단위 Ea. / Cs.
0452-534	PST-32	178,360	16~32	1 / 6

(2) 결속기



- FRONT ACTION TYPE 결속기로서 PET 밴드를 강하게 결속할 수 있음

ORDER NO.	MODEL NO.	PRICE, ₩ Ea.	사용규격(mm)	포장단위 Ea. / Cs.
0451-325	PFS-16	54,490	16	1 / 20
0441-399	PFS-19	54,490	19	1 / 20

수동 & 자동 밴딩기용 밴드, PP Strapping Band KOREA



(1) 수동 밴딩기용, Mannual Use

- 클립, 버클을 이용해서 소하물 결속시 사용



(2) 자동 밴딩기용, Machine Use

- 자동 결속기에 사용되는 밴드, 주로 박스 포장, 중량물 패키징 사용

판매단위 화물시착물 <B3>

ORDER NO.	폭(mm)	중량(kg)	PRICE, ₩	색상
0302-852	18	8	19,520	● 황색

판매단위

ORDER NO.	폭(mm)	중량(kg)	PRICE, ₩	색상
0302-837	15	8	19,520	● 황색
0302-848	18	8	19,520	● 황색

PS 강력 결속 밴드, PS Heavy-duty Strapping Band KOREA



- 길이 : 약 1,200M(폭 16mm) 약 800M(폭 19mm)
- 철밴드 대용으로 사용, 무거운 하중의 파렛트 결속, 철근 및 기계의 중하중 상품 포장

판매단위 화물시착물 <B3>

ORDER NO.	두께 (T)	폭 (mm)	중량 (kg)	PRICE, ₩	타입
0306-872	1.0	16	20	83,310	엠보싱 타입
0306-873	1.0	19	20	83,310	타입

Articles	Cat. No	Description
----------	---------	-------------

A-Pack 밴드크립, Strapping Clip / Seal KOREA

(1) 철크립 (2) PP크립 (3) PET크립

판매단위 BOX <B3>

ORDER NO.	두께 (T)	폭 (mm)	중량 (kg)	PRICE, ₩	타입
(1) 0302-786	0.8	16	3.5	8,830	철크립 (ㄷ형)
0302-758	0.8	19	3.5		
(2) 0302-759	0.4	15	2	6,190	PP크립
0302-762	0.4	18	2		

ORDER NO.	규격(mm)	입수량(EA)	PRICE, ₩	타입
(3) 0306-043	16	1,000	62,040	PET크립
0328-581	19	1,000	71,260	

KDY 자동바 끈, Ratchet Tie Down KOREA

■ 높은 안전성
 ■ 제품손상 및 미끄럼 방지
 ■ 제품 고정 용이

<B3>

ORDER NO.	규격(폭×길이)	PRICE, ₩ Ea.	재질	포장단위 Ea. / Cs.
0521-922	25mm×4M	4,180	환봉(PE)	1 / 10
0521-923	38mm×5M	8,820	환봉(PE)	1 / 10
0477-384	50mm×8M	10,360	주걱(PP)	1 / 10
0477-385	50mm×10M	11,090	주걱(PP)	1 / 10

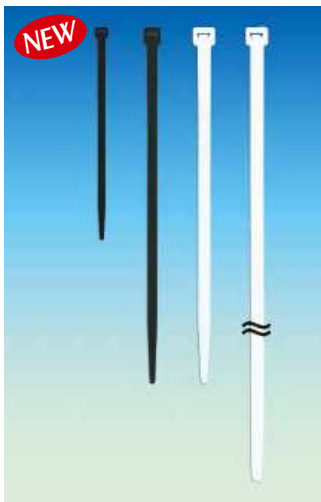

Cais® Nylon Cable Tie, 나일론 케이블타이 NEW

* Nylon 66, 94V-2 Certificated by UL. Heat-resisting, Erosion Control, Insulate well and not Apt to Age.
 * Natural (or White, Standard Color), UV Black and Other Color are Available as Requested.

<B4>

ORDER NO.		Width×Length(mm)	dh pk. Price, ₩	Cs.	Price, ₩
White	Black				
C2.T25100	C2.T25100.1	100×2.5	100ea 580	10dh pk.	3,790
C2.T36140	C2.T36140.1	140×3.6	100ea 1,250	10dh pk.	8,270
C2.T48200	C2.T48200.1	200×4.8	100ea 2,470	10dh pk.	16,390
C2.T50270	C2.T50270.1	270×5.0	100ea 4,420	5dh pk.	14,710
C2.T48300	C2.T48300.1	300×4.8	100ea 4,880	5dh pk.	16,240
C2.T76300	C2.T76300.1	300×7.6	100ea 4,420	5dh pk.	14,710
C2.T76370	C2.T76370.1	370×7.6	100ea 8,270	3dh pk.	16,520
C2.T90450	C2.T90450.1	450×9.0	100ea 17,640		
C2.T90540	C2.T90540.1	540×9.0	100ea 28,360		
C2.T90780	C2.T90780.1	780×9.0	100ea 44,110		



Cais® Marker Tie, Available to Tie Max. φ22mm, with Tag, 마커 타이

■ 펜과 스티커 등으로 분류별 마킹이 가능하여 효율적인 선 정리 가능
 * Nylon 66 94V-2 Certificated by UL. Acid Control and not Easy to Age.
 * Write Down the Marker on the Tag, Tag Size w8×L25mm

<B4>

ORDER NO.	Spec	dh pk. Price, ₩	Cs.	Price, ₩
C2.100MT	Marker Tie, w2.5×L100mm	100ea 2,510	10dh pk.	16,670
C2.200MT	, w2.5×L200mm New	100ea 3,050	10dh pk.	20,310



Cais® Reusable Cable Tie, Easy Assembling, 재사용 케이블 타이

■ 해제 버튼이 있어서 쉽게 재사용 가능
 * Nylon 66 Certificated by UL. * Easily Assembled by Hand or with Pliers

<B4>

ORDER NO.	Spec	dh pk. Price, ₩	Cs.	Price, ₩
C2.200RT	Reusable Cable Tie, w4.8×L200mm, Max. Bundle φ50mm New	100ea 5,380	10dh pk.	35,840
C2.250RT	, w7.2×L250mm, Max. Bundle φ65mm	100ea 10,560	5dh pk.	35,150



Cais® Cord Band, General Purpose, 코드/케이블 밴드(타이)

■ Supplied by Cais® in Korea ■ Cord Band, Polyethylene

<B4>

ORDER NO.	Spec	dh pk. Price, ₩	Cs.	Price, ₩
C2.CB150	Cord Band, Color-Natural, 157mm	100ea 3,290	5dh pk.	10,920
C2.CB150.1	, Color-Black, 157mm New	100ea 3,290	5dh pk.	10,920

Articles

Cat. No

Description

NEW



Lever

Carabiner

Cable Tie Band, with Carabiner, Ideal for Organized Storage, 케이블 타이 정리기 NEW

- 케이블 타이 작업 및 보관에 효과적
- * Phosphorescence Function (About 30 Min Luminous after Light Absorption)
- * Simple Lever Operation, easy to use with One-touch Method
- * Includes Carabiner for easy Holding * Inner Diameter : up to 35mm

DH.Ele3001 Cable Tie Band, 8.7×8×12mm

<B4>

Ea.	Price, ₩
	5,880

NEW



3M® Scotch® “610” Cellophane Film Tape, with Pressure Sensitive Rubber Resin, Up to 140°C Ideal for High-Temperature Packaging, Adhesive to a Variety of Materials, 라이트 듀티 테이프 NEW

- 미국 ASTM 규격의 도장 부착력 테스트 법에 가장 부합하는 도장 피막 검사용 테이프
- 고온 포장 용도로 사용하기 위해 고안된 투명 필름 테이프 ■ 페인트 공정, PCB 인쇄 공정에서 많이 사용
- 천연 고무 접착제는 높은 초기 접착 강도를 자랑하며 다양한 재료에 접착 가능
- * Dimensionally Stable on a Wide Variety of Applications Up to 300°F (140°C)
- * Controlled Consistent Unwind for Reliable Hand Dispensing.
- * Easily Dispensed. * Excellent holding properties.

3M.08.610 Cellophane Film Tape, 25mm×65.6M, Thick 0.058mm, Clear

<B4>

Pk.	Price, ₩
1roll	19,180

NEW



3M® Scotch® “372KS” Box Packing Tape, Transparent & Translucent Milky-Amber Ideal for High Strength Packaging, Solvent-type, Durable, w48×L50m, 박스포장용 테이프, 보급형 NEW

- 초기 접착력 우수, 모서리 찢김 저항성 ■ Solvent-type Acrylic Adhesive Coated Tape
- * High Edge Tear and Split Resistance * Excellent Tensile Strength

3M.08.372KS.C “372KS” Box Tape, 48mm×L50m, Clear

3M.08.372KS.A

, Milky-Amber

<B4>

Pk.	Price, ₩	Cs.	Price, ₩
1roll	1,110	50pk	
1roll	1,110	50pk	



포장테이프, 베이지 & 투명, OPP Packing Tape

KOREA

NEW



- 추위에서도 뛰어난 품질을 나타내어 저온 환경에서도 사용 가능

(1) 기본형; 베이지&투명

(1) 러버 기본형

<B3>

ORDER NO.	폭(mm)	길이(M)	PRICE, ₩ Ea.	색상	재질	포장단위 Ea. / Cs.
0516-214	48	40	1,010	● 베이지	러버	1 / 50
0516-194			1,010	○ 투명	러버	

NEW



- 접착력이 강해 추위에 강하고 냉동 창고에서도 사용 가능
- 식품 관련 업체 사용

(2) 냉동용; 베이지&투명

(2) 저온 냉동용

ORDER NO.	폭(mm)	길이(M)	PRICE, ₩ Ea., ₩	색상	포장단위 Ea. / Cs.
0516-663	48	40	1,010	● 베이지	1 / 50
0476-992	48	40	1,010	○ 투명	



마스킹 테이프, Masking Tape, White, Multiuse

KOREA

NEW



- 접착력이 우수하며 색상별로 선명도가 뛰어나 표지 구분, 각종 디자인, 데코레이션, 학습재료 등 다양하게 사용 가능

<B3>

ORDER NO.	폭(mm)	길이(M)	PRICE, ₩ Ea.	색상	포장단위 Ea. / Cs.
0476-968	12	40×2개	980		1 / 58
0516-206	25	40	980	○ 백색	1 / 56
0516-207	50	40	1,940		1 / 28



크라프트(종이) 테이프, Kraft Packing Tape

KOREA

NEW



- 크라프트지(종이) 재질로 윗면에 PE라미네이팅 처리를 하여 점착 코팅한 테이프
- OPP 테이프에 비해 우수한 점착력과 찢김성이 우수함

<B3>

ORDER NO.	폭(mm)	길이(M)	PRICE, ₩ Ea.	포장단위 Ea. / Cs.
0483-846	50	40	1,620	1 / 50

Articles Cat. No Description

 **취급주의용 테이프, "Handle-care" Packing Tape** KOREA



- 냄새가 적고 잘 찢어지지 않음
- 뛰어난 접착력을 자랑하며 주의를 필요로 하는 상품을 포장시 편리함

<B3>

ORDER NO.	폭(mm)	길이(M)	PRICE, ₩ Ea.	포장단위 Ea. / Cs.
0477-000	48	40	1,110	1 / 50



3M® "3381" Aluminum Foil Tape, High-strength & UV Resistance, 0.07mm Thickness, 48mm × 45.7M
Coated with an Acrylic Pressure Sensitive Adhesive, **알루미늄 호일 테이프, 우수한 내습성 & 지속력** NEW

- 고내열도 ■ 우수한 UV 저항성 ■ 내습성 & 지속력 탁월 ■ 얇고 유연하여 곡선작업에 유리함
- Applications in Cold Weather Conditions and Excels in Humidity
- Ideal for Light Reflecting · Heat Shielding · Moisture Barrier · Thermal Conducting · Sealing · Splicing
- * Acrylic Adhesive Supplies Superior Temperature and UV Resistance for Durability
- * Performs and Serves as an Excellent Barrier against Factors such as Moisture, Dust and Flame
- * Malleable foil is conformable, capable of adhering to irregular surfaces
- * Easy-to-tear Design offers Simple Application

3M.08.3381 "3381" Aluminum-foil Tape, 0.07mm Thickness, 48mm × 45.7M, Thickness 0.07mm

Pk.	Price, ₩
1roll	7,730



 **알루미늄 테이프, 열전도 부위 보호용에 적합, Aluminium Foil Tape** KOREA

- 냉장고나 세탁기등 냉각 및 보온성을 높이기위해 콘덴서 코일을 고정, 열을 전도시키는 용도에 사용
- 일반 가정에서 싱크대 보수 및 열전도 부위 보호용 등 다양한 용도로 사용

<B3>

ORDER NO.	폭(mm)	길이(M)	PRICE, ₩ Ea.	색상	포장단위 Ea. / Cs.
0516-208	50	5	820	● 은색	1 / 50

 **다용도 면(천) 테이프, Multiuse Cloth Tape** KOREA



- 두께가 두꺼워서 파이프 등과 같은 소재의 표면보호에 적합
- 모든 박스종류의 포장 등 다양한 각도의 용도로 사용
- 손으로 쉽게 절단되어 작업이 용이

<B3>

ORDER NO.	폭(mm)	길이(M)	PRICE, ₩ Ea.	색상	포장단위 Ea. / Cs.
0516-199	48	15	1,570	● 녹색	1 / 40
0516-656		25	2,560		1 / 40

 **3색 식별 형광 테이프, 노랑/녹색/적색** KOREA
3-colored Fluor-Tape, Ideal for Identification



- 야간에 불빛을 받아 밝은 빛의 광선을 반사해 안전의 경고나 비상구, 창문, 유리등 필요한 부분에 다용도로 사용 가능

<B3>

ORDER NO.	폭(mm)	길이(M)	PRICE, ₩ Ea.	색상	포장단위 Ea. / Cs.
▶ 0477-002	48	2	1,350	● 노랑	1 / 50
0477-004				● 녹색	
▶ 0477-003				● 적색	

 **빛 반사 테이프, Reflective Tape, w50 & 100mm, L45.7m**

- 각종 산업 현장, 공사 현장 등 안전 표시
- 빛 반사로 시인성 확보

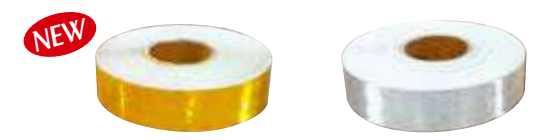

<B4>

ORDER NO.	색상	PRICE, ₩	폭(mm)	길이(M)
0438-129	● 황색	18,630	50	45.7
0438-130		37,240	100	
0438-127	○ 백색	18,630	50	45.7
0438-128		37,240	100	

Articles

Cat. No

Description



(1) with Dome Cap, 0.2ml



(2) with Flat Cap, 0.2ml

Wisdom PP 0.2ml PCR Tube, Transparency, Ultra Thin Wall, -196°C + 121°C **NEW**
 With Domed or Flat Cap, DNase·RNase·Pyrogen- and Endotoxin-Free, 0.2ml PCR 튜브와 캡

- Made in Korea ■ Made of Medical Grade Polypropylene(PP)
- 완벽한 밀폐로 시료의 증발을 방지하고 얇고 부드러운 재질로 열전달이 효율적으로 정확함.
- Ultra Thin-wall Offers High Degree of Transparency, Easy for Observation and Heat Conduction
- * DNase, RNase, and Endotoxin Free. * 500pcs / Inner Pack, 1,000pcs / Outer Case.
- * Soft Opening and Closing / Excellent Sealing.
- * Temperature Range: -196°C (in Gas Phase)+121°C
- * Attached cap allows opening and closing with one hand
- * Universal Fits for the PCR Instrument
- * Domed Caps Ensure Efficient Heat Transfer



DH.Tub3101 (1) Tube, PCR, PP, 0.2ml, with Attached Dome Cap
DH.Tub3102 (2) , with Attached Flat Cap

<L1>

Cs.	Price, ₩
1000ea	39,200
1000ea	39,200

Wisdom PP 0.2ml PCR 8-Strips Tube, Transparency, Ultra Thin Wall, -196°C + 121°C **NEW**
 With Domed or Flat Cap, DNase·RNase·Pyrogen- and Endotoxin-free, CE Certified, 0.2ml PCR 스트립 튜브와 캡



PCR 8-Strips Tube



(1) Attached Dome Cap (2) Attached Flat Cap



(3) with Unattached Flat Cap

- Made in Korea ■ Made of Medical Grade Polypropylene(PP) ■ CE Certified
- 완벽한 밀폐로 시료의 증발을 방지하고 얇고 부드러운 재질로 열전달이 효율적으로 정확함.
- Ultra Thin-wall Offers High Degree of Transparency, Easy for Observation and Heat Conduction
- * DNase, RNase, and Endotoxin Free. * 8-Strip × 12ea / Inner Pack, 10 Inner Pack / Outer Case.
- * Soft Opening and Closing / Excellent Sealing.
- * Temperature Range: -196°C (in Gas Phase)+121°C
- * Universal Fits for the PCR Instrument
- * Can be used with 8-channel Hand-held Micropipettors
- * Tube Strips and Cap Strips can be Cut Easily and used as Individual Tubes
- * Packed in Tamperproof Resealable Bags



(1) PP 0.2ml PCR 8-Strips Tube with Attached Dome Cap

DH.Tub3111 Tube, PCR, PP, 0.2ml, with Attached Dome Cap

<L1>

Pk.	Price, ₩
120ea	56,000

(2) PP 0.2ml PCR 8-Strips Tube with Attached Flat Cap

DH.Tub3115 Tube, PCR, PP, 0.2ml, with Attached Flat Cap

Pk.	Price, ₩
120ea	56,000

(3) PP 0.2ml PCR 8-Strips Tube with Unattached Flat Cap

DH.Tub3116 Tube, PCR, PP, 0.2ml, with Unattached Flat Cap

Pk.	Price, ₩
120ea	72,800

Articles	Cat. No	Description
----------	---------	-------------

SI Analytics® Digital One-channel Multi-parameter Meter, "Lab 875" & "Lab 875P" NEW
 With IDS Sensor, Safe Determination of pH, ORP, Conductivity and Dissolved Oxygen, <Germany-made>, 디지털 멀티미터



"Lab 875" & "Lab 875P" Multi-parameter Meter

- **Automatic Sensor Recognition**
- **Optimized Measurements and Efficient Documentation in the Simplest Manner.**
- **CMC(Continuous Measurement Control) and QSC(Sensor Quality Control)**
- **Optically Installed Thermal Printer : Lab 875P**
- **Process Signals in the Sensor Digitally so that Precise and Interference-free Measurements are enabled even with Long Cables.**

- * Automatic, Digital Capture of all Sensor Data.
- * User Administration Capabilities for the Safe Allocation of User and Measuring Results.
- * Transmission of all Data in ".csv" format via USB Interface to PC.
- * **Complete Set with** : Main Unit, Stand, Power Supply and Buffer Solution.

Parameter	pH, mV, Conductivity, Spec. Resistance, Salinity, TDS, Temperature
Calibration Points	pH (1~5 points), D.O. (1 point), Conductivity (1 point)
Calibration Timer	1~999 days
Memory	Manual 500 Data Sets, Automatic 4,500 Data Sets
Interface	Mini USB-B
Display	Graphic, BW
Power Supply	Universal Power Supply(100~240V, 50/60Hz Power pack), 4 × 1.5 V AA Batteries

Ordering Information

Cat. No.	Type No.	Description	Ea.	Price, ₩
SG.285206720	Lab 875 pH set	Digital Multi-meter Lab 875 pH set with BL 14pH IDS sensor		2,629,650
SG.285206730	Lab 875 Cond set	Digital Multi-meter Lab 875 Cond set with LF 413T IDS sensor		3,061,080
SG.285206740	Lab 875P pH set	Digital Multi-meter Lab 875P pH set with BL 14pH IDS sensor		3,451,410
SG.285206750	Lab 875P Cond set	Digital Multi-meter Lab 875P Cond set with LF 413T IDS sensor		3,872,560

Spare & Optional Accessories

Cat. No.	Type No.	Description	Ea.	Price, ₩
SG.285202440	FDO 1100 IDS	Optical ; Oxygen Sensor, Temp. sensor NTC30kOhm, 1.5m Cable with Plug		1,822,260
SG.285129140	BlueLine 14 pH IDS	Spare ; Glass Shaft, with Temp.-sensor NTC 30 kOhm, 1.5m cable, L120 mm, φ12mm, -5°C +100°C, 0~14 pH		463,130
SG.285202410	LF 413T IDS	Spare ; 4 pole Cell, 1.5m cable with plug, 0.475 cm-1, Temp.-sensor NTC 30 kOhm, L120mm, φ15.3mm, -5°C +80°C		1,090,890
SG.285206370	Z 610	Spare ; Printer paper for Lab 875P, 1 Roll		40,870

SI Analytics® Digital High-performance Multi-parameter Meter Set, "ProLab 2500" NEW
 With 3 Channel IDS Sensor - pH · Cond. · D.O., Color Digital Display, Antibacterial Keyboard Cover, <Germany-made>, 고성능 디지털 멀티미터



"ProLab 2500" Multi-parameter Meter Set

- **Three Universal Measuring Channels**
 - **Measuring pH, ORP, ISE, D.O., and Conductivity**
 - **QSC (Quality Sensor Control) Icon provide Precise Information about the actual State of the Electrode.**
 - **Digital Sensor Recognition**
 - **Antibacterial Keyboard**
- * Automatic, Digital Capture of All Sensor Data for Retracement of Measured Values.
 * Data output to PC, USB memory stick or selected Printers. * Memory with 10,000 possible entries.
 * **Complete Set with** : Main Unit, Stand, Power Supply, Electrodes and Testing Solution.

Parameter	pH, mV, Conductivity, Spec. Resistance, Salinity, TDS, Temperature
Calibration Points	pH (1~5 points), ISE(2~7, requires adapter), D.O. (1 point), Conductivity (1 point)
Calibration Timer	1~999 days
Memory	Manual 500 Data Sets, Automatic 10,000 Data Sets
Interface	USB-A, Mini USB-B
Display	Color Graphic
Power Supply	Universal Power Supply(100~240V, 50/60Hz Power pack), 4 × 1.5 V AA Batteries

Ordering Information

Cat. No.	Type No.	Description	Ea.	Price, ₩
SG.285206770	ProLab 2500 pH set	Digital Multi-meter ProLab 2500 with A162 IDS pH sensor		5,300,360
SG.285206790	ProLab 2500 pH/Cond/Ox set	Digital Multi-meter ProLab 2500 with A162 IDS pH sensor, LF 413T IDS Cond Sensor and FDO 1100 IDS DO Sensor		7,858,080

Spare & Optional Accessories

Cat. No.	Type No.	Description	Ea.	Price, ₩
SG.285100120	A 162 IDS	Spare ; Glass Shaft, with Temp.-sensor NTC 30 kOhm, 1.5m cable, L120 mm, φ12mm, -5°C +100°C, 0~14 pH		551,170
SG.285202410	LF 413T IDS	Spare ; 4 pole Cell, 1.5m cable with plug, 0.475 cm-1, Temp.-sensor NTC 30 kOhm, L120mm, φ15.3mm, -5°C +80°C		1,090,890
SG.285202440	FDO 1100 IDS	Optical ; Oxygen Sensor, Temp. sensor NTC30kOhm, 1.5m Cable with Plug		1,822,260

Suntex® Portable pH · ORP · Ion · Temp. Meter set, "TS-210", "TS-230" & "TS-250", -2~20pH, ±2000mV **NEW**

With Vertical Display and Graphical Icon, IP65 Waterproof, Data logger, 휴대용 다기능 pH · Ion 미터 세트

NEW



"TS-210", "TS-230" & "TS-250" Portable pH · Ion Meter

- * The Vertical Display, and Complete Graphical Icon with Text Information Menu Provide you the Intuitive Operation.
- * Rich Functions under the Simple and Easy-to-understand Graphical Menu
- * with IP65 Splashing Water Protection * Easy Data Transmitting
- * The Data Logger Function can Automatically Save the Measurement with Time Interval.
"TS-210" up to 100 Sets, "TS-230" & "TS-250" up to 50,000 Sets
- * **Complete Set with** : Basic Unit, Carrying Case, 4 × AA Battery, Operation Manual, (with/without) pH Electrode

<L1>

Model	"TS-210"	"TS-230"	"TS-250"
Measurement Range	-2~20pH, -2000~2000mV		-2~20pH, -2000~2000mV 0.001~999.999ppm
Resolution & Accuracy	0.01pH, 1/0.1mV ±0.01pH, ±0.05%	0.001pH, 1/0.1mV ±0.005pH, ±0.05%	0.001pH, 1/0.1mV, 0.001ppm ±0.005pH, ±0.05%, ±0.5%
Temperature Compensation	NTC30K / PT1000 ATC and MTC		
Data Storage	100 Sets	50,000 Sets	
Data Transmitting	-		Micro USB
Calibration (pH)	1~3 Point	1~5 Point	
Size and Weight	w194 × d82 × h38mm, 250g		
Protection	IP65		
Power Supply	4 × 1.5V AA or 1.2V NiMH	4 × 1.5V AA or 1.2V NiMH, Micro USB	
Cat. No. (without Cond. Probe)	SU.TS210	SU.TS230	SU.TS250
Price, Each. ₩	547,780	701,550	1,066,730
Cat. No. (with Cond. Probe)	SU.TS210PA	SU.TS230PA	SU.TS250PA
Price, Each. ₩	630,230	776,300	1,123,210

Spare & Optional Accessories

		Ea.	Price, ₩
SU.PH1000	Spare ; pH Combination Electrode, PH1000, Plastic Shaft, BNC		115,630
SG.285129258	Optional ; , BlueLine 25 pH, Plastic Shaft, BNC		234,210
SU.8082	Spare ; Temperature Probe, ATC		130,260
SU.8.03	; Calibration Buffer Solution, pH 4.00, 500ml		16,740
SU.8.04	; , pH 7.00, 500ml		16,740
SU.8.23	; , pH 10.00, 500ml		16,740

Articles

Cat. No

Description



Microlit® Comfort Grip Pipet fill™, with 2 LED Lamp for Battery Status, for 1~100ml Pipets
 With Light Weight/-Rechargeable Battery 220V Charger, Fully Autoclavable, **피펫에이드** **NEW**

- **Certified ISO 9001:2008, DAkkS(German A.A.), IAF and CE**
- **Continuous Adjustment of Pump Speed during Operation and Comfortable Grip**
- * Two LEDs : Red - Low Charging, Green - Charging Status
- * Rechargeable Battery and a Charger.
- * Single Knob Dual Dispensing Mode : 1. Gravity Mode - on Half Press.
 2. Blowout Mode (Motor Powered) - on Full Press
- * In-line Membrane Filter (0.2 micron) Prevents Aerosol Contamination and Liquid from Entering.
- * Ni-MH 3.6V Rechargeable Batteries are Used in Combination with Low Power Consumption Circuit and Vacuum/Pressure Pump. Allows Eight Hours of Continuous Operation. <L1>

- ML.NE.GR.220V** Pipet Aid, 1~100ml
- WI.5.380.006E** Spare Filter, for Pipet Controller
- WI.5.382.010** Spare Silicone Adapter
- ML.NE.E.STND** Optional Acrylic Stand for Easyfill Pipet Aid **New**

Ea. Price, ₩	Pk.	Price, ₩
	1ea	122,240
15,280	5ea	70,630
32,260		
33,400		



(1) 5~200 µl Model



(2) 250~1000 µl Model

Microlit® Miniature Fixed Volume Micropipettor, Fully Autoclavable, L130mm, 5~1000 µl
 With Optimum Size, CE · ISO · DAkkS · IAF Certified, 미니 고정형 피펫터

- Unique Tip-Cone
- Certified ISO 9001:2008(International Standard Organization), DAkkS(German Accreditation Authority), IAF(International Accreditation Forum), CE (Conformity to European)
- Specially Designed for Use with Diagnostic Kits.
- High Volume of 200/250/500/1000ul are Specially Designed for Routine Laboratory Work.
- Optimum Size (L130mm)
- Strict Quality Control
- Two-step Plunger Operation

* The Tip Cone of 5 µl, 10 µl, 20 µl is Designed to Accept both Regular 200 µl Tips or Ultra Micro Tips up to 20 µl
 * Use of Ultra Micro Tips for Volumes up to 20 µl Enhances the Accuracy and Precision very Significantly.
 * Can be Used for Reverse Pipetting and Repetitive Pipetting.
 * Supplied with Individually Calibrated as per ISO 8655 Standards and Batch Calibration Certificate

<L1>

ML.LIL.5	(1) Pipettor, Micro, Fixed, Mini,	5 µl, Accu,	≤ ±2.5 µl, cv. ≤ ± 1.5% New
ML.LIL.10		, 10 µl,	, ≤ ± 1.2 µl, cv. ≤ ± 0.8% New
ML.LIL.20		, 20 µl,	, ≤ ± 1.0 µl, cv. ≤ ± 0.5% New
ML.LIL.25		, 25 µl,	, ≤ ± 1.0 µl, cv. ≤ ± 0.4% New
ML.LIL.50		, 50 µl,	, ≤ ± 1.0 µl, cv. ≤ ± 0.4% New
ML.LIL.100		, 100 µl,	, ≤ ± 0.8 µl, cv. ≤ ± 0.3% New
ML.LIL.200		, 200 µl,	, ≤ ± 0.8 µl, cv. ≤ ± 0.3% New
ML.MM.250	(2) Pipettor, Micro, Fixed, Mini,	250 µl,	, ≤ ± 0.8 µl, cv. ≤ ± 0.3%
ML.MM.500		, 500 µl,	, ≤ ± 0.8 µl, cv. ≤ ± 0.3%
ML.MM.1000		, 1000 µl,	, ≤ ± 0.8 µl, cv. ≤ ± 0.3%

Ea.	Price, ₩
	11,020
	11,020
	11,020
	11,020
	11,020
	11,020
	11,020
	11,020
	11,020
	11,020
	11,020
	11,020

Articles	Cat. No	Description
----------	---------	-------------

Microlit® classic Comfortgrip Adjustable Micropipettor, Fully Autoclavable, 0.2~1000µl, 5 & 10ml, with Color-coded With Digital Display, Wide Pipettor Tip Compatibility, CE · ISO · DAkkS · IAF Certified, 가변형 마이크로- & 매크로-피펫터

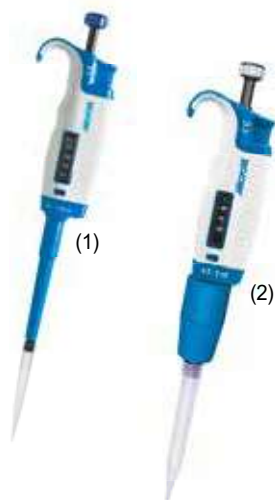

Variable Micro- & Macro Pipettor



(3)-1

(3)-2

- **Soft Grip & Ergonomic Design**
- **Incl. Calibration Report**
- **Certified ISO 9001:2008(International Standard Organization), DAkkS(German Accreditation Authority), IAF(International Accreditation Forum), CE (Conformity to European Authority)**
- **Universal Tipcone (Compatible with Most of the Internationally Accepted Standard Tips.)**
- **Suitable for the Various Tips like Gilson®, Eppendorf®, Axygen®, Kartell®, Stockwell®, etc**
- **Large Grippy for Comfortable Grip**
- **Easy to Calibrate and Maintenance**

- * High Quality Spring Mechanism Ensures Softer Plunger Movement.
- * Easy Volume Adjustment by Simply Turning the Plunger.
- * Re-calibration can be Performed Easily by the User.
- * Soft Click Sound at Every Increment Ensures Perfect Volume Setting and no Accidental Volume Change.
- * 4 Digit Display with Subdivisions Provides Small Volume Increments.
- * Built-in Streamlined Tip Ejector Facilitates Easy Tip Ejection and Access to Narrow Necked Bottles and Tubes.
- * Placement and Good Design Allows Easy Single Handed Tip Ejection.
- * Color-coded for Easy Identification
- * Including Pipettor Holder.

(1) Micropipettor

Model	Capacity	Accuracy	Precision	CV%
ML.RBO.2	Pipettor, Micro, 0.2~2.0 / 0.002µl	≤ ± 0.04µl	≤ ± 2.0 %	1.2 CV%
ML.RBO.10	, 0.5~10 / 0.02µl	≤ ± 0.1µl	≤ ± 1.0 %	0.5 CV%
ML.RBO.20	, 2~20 / 0.02µl	≤ ± 0.16µl	≤ ± 0.8 %	0.4 CV%
ML.RBO.50	, 5~50 / 0.1µl	≤ ± 0.4µl	≤ ± 0.8 %	0.4 CV%
ML.RBO.100	, 10~100 / 0.2µl	≤ ± 0.6µl	≤ ± 0.6 %	0.2 CV%
ML.RBO.200	, 20~200 / 0.2µl	≤ ± 1.2µl	≤ ± 0.6 %	0.2 CV%
ML.RBO.1000	, 100~1000 / 1µl	≤ ± 6µl	≤ ± 0.6 %	0.2 CV%

<L1>	
Ea.	Price, ₩
	60,500
	60,500
	60,500
	60,500
	60,500
	60,500

(2) Macropipettor

ML.RBO.5000	Pipettor, Macro, 0.5~5 / 0.01ml	≤ ± 30µl	≤ ± 0.6 %	0.2 CV%
ML.RBO.10000	, 1~10 / 0.02ml	≤ ± 60µl	≤ ± 0.6 %	0.2 CV%

Ea.	Price, ₩
	60,500
	60,500

(3) Optional Stand, Material : Acrylic & Polypropylene

ML.MS.1	Stand, for 3 pipettors, Acrylic	
ML.MS.2	, for 6 pipettors, Acrylic	
ML.FVO.1	Table Stand, for 6 pipettors, Polypropylene New	



Ea.	Price, ₩
	24,460
	29,350
	89,060

Microlit® classic Comfortgrip Multi-channel Micro Pipettor, 8- & 12- Channel, 0.5~300µl, with Color-coded, Ergonomic Design With Digital Display, Fully Autoclavable, ISO 9001:2008 CE · ISO · DAkkS · IAF Certified, Multi 가변형 다채널 피펫터

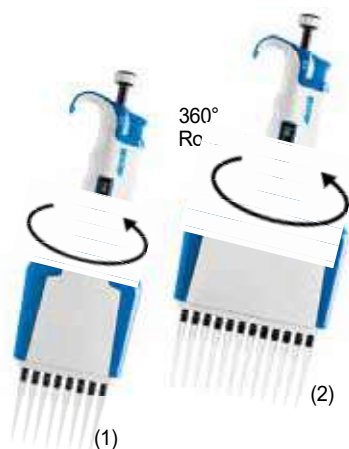

Multi-Channel Micropipettor, 0.5~300µl

NEW



Table Stand for 6 pipettors

- **Incl. Calibration Report**
- **Easy Tip Ejection**
- **Certified ISO 9001:2008(International Standard Organization), DAkkS(German Accreditation Authority), IAF(International Accreditation Forum), CE (Conformity to European Authority)**
- **Universal Tipcone (Compatible with Most of the Internationally Accepted Standard Tips.)**
- **Suitable for the Various Tips like Gilson®, Eppendorf®, Axygen®, Kartell®, Stockwell®, etc.**
- **Easy Volume Adjustment**
- **Large Grippy for Comfortable Grip**
- **Soft Grip & Ergonomic Design**
- **Easy to Calibrate and Maintenance**
- **Lower housing can be rotated 360° providing flexibility during operation.**

- * High Quality Spring Mechanism Ensures Softer Plunger Movement.
- * Easy Volume Adjustment by Simply Turning the Plunger.
- * Soft Click Sound at Every Increment Ensures Perfect Volume Setting and no Accidental Volume Change.
- * 4 Digit Display with Subdivisions Provides Small Volume Increments.
- * Specially Designed Large Grippy is Provided for Comfortable Grip and Easy During Working.
- * Built-in Streamlined Tip Ejector Facilitates Easy Tip Ejection and Access to Narrow Necked Bottles and Tubes.
- * Re-calibration can be Performed Easily by the User.
- * Color-Coded for Easy Identification

(1) 8-Channel Micropipettor

ML.RBO.MCA.8.10	Pipettor, 8-Channel, 0.5~10 / 0.02µl	≤ ± 0.16µl	≤ ± 1.6 %	1 CV%
ML.RBO.MCA.8.50	, 5~50 / 0.1µl	≤ ± 0.4µl	≤ ± 0.8 %	0.4 CV%
ML.RBO.MCA.8.300	, 40~300 / 0.2µl	≤ ± 2.4µl	≤ ± 0.8 %	0.3 CV%

<L1>	
Ea.	Price, ₩
	239,570
	239,570
	239,570

(2) 12-Channel Micropipettor

ML.RBO.MCA.12.10	Pipettor, 12-Channel, 0.5~10 / 0.02µl	≤ ± 0.16µl	≤ ± 1.6 %	1 CV%
ML.RBO.MCA.12.50	, 5~50 / 0.1µl	≤ ± 0.4µl	≤ ± 0.8 %	0.4 CV%
ML.RBO.MCA.12.300	, 40~300 / 0.2µl	≤ ± 2.4µl	≤ ± 0.8 %	0.3 CV%

Ea.	Price, ₩
	268,900
	268,900
	268,900

(3) Optional Stand, Material : Polypropylene **NEW**

ML.FVO.1	Table Stand, for 6 pipettors
----------	------------------------------

Ea.	Price, ₩
	89,060

ABDOS® LASTDROP™ Low Retention Pipettor Tip, with Precise Graduation, for Minimal Sample Loss, 0.2~1,000 μl NEW

Ideal for Microbiological Lab, DNase · RNase · Pyrogen-Free, with Bulk · Rack · Sterile Rack · Refill Pack-type, **고정밀 피펫터 팁, 시료손실 최소화**

- Micro Pipettor Tips(0.2~1,000 μl) Compatibility : Axygen®, Biohit®, Brand®, Eppendorf®, Thermo Finnpipe®, Gilson®, Labnet®, Nichiryo®, Vistalab®, Wheaton-Socorex®
- Sample Retention is 10 times Less than General Standard Tips
- How to Reduce Sample Retention : ① High Grade Resin Technology & Additives Engineering for Low Binding Surface
 ② Diamond Polishing for Enhance Low Binding ③ Injection Moulding Process

- Production and Individual Packaging according to Clean Room 8
- Optimal Surface for Dispensing Minimal Sample Loss of Highly Viscous Liquids or Samples Containing Detergent
- Minimum Retention with Viscous Liquid thus Reducing Sample Retention Save on Costly Reagents

* Can Download the Certificate from 'http://www.abdoslifesciences.com' with Product Code and Lot Number.

* Manufactured from Ultra Pure USP Class VI Certified Virgin Polypropylene to Ensure the Highest Quality & Confirms to US FDA 21 CFR. Free from Heavy Metals, Natural Rubber & Inhibitory Plasticizers * Free from Bacteriostatic & Fungistatic Property suitable for Microbiology

* Precise Graduation marks for Error Free Pipetting * High Clarity for better Visibility of Samples. * Natural Color



(1) Bulk Tip in Resealable Bag, 0.2~1,000 μl

* Resealable Bulk-bag Keeps the Product Free of Contamination and Dust

<L1>

AB.P10001 Tip, Low Retention, Bulk-type, Graduated, 0.2~10 μl

AB.P10002 , 0.2~10 μl , Extended

AB.P10003 , 2~200 μl , Bevelled-type

AB.P10005 , 2~300 μl

AB.P10006 , None-Graduated, 100~1,000 μl

Cs.	Price, ₩
1000ea	20,820
1000ea	20,820
1000ea	20,820
1000ea	21,520
500ea	11,500

(2) Racked Tip with 96 Tips, 0.2~1,000 μl

* Polypropylene(PP) Hinged Rack : Autoclavable at 121 °C, Robust, Sturdy and Reusable

* Rack is Printed with Volume Range, Lot Number * Stackable

* with Transparent Lid

AB.P10020 Tip, Low Retention, Racked Set, Graduated, 0.2~10 μl

AB.P10021 , 0.2~10 μl , Extended

AB.P10022 , 2~200 μl , Bevelled-type

AB.P10024 , 2~300 μl

AB.P10025 , None-Graduated, 100~1,000 μl

Pk.	Price, ₩	Cs.	Price, ₩
1rack	5,280	10rack	48,830
1rack	5,280	10rack	48,830
1rack	4,970	10rack	45,920
1rack	5,840	10rack	54,010
1rack	5,790	10rack	53,460



(3) Sterilized Racked Tip with 96 Tips, 0.2~1,000 μl

* Sterilized by Gamma Radiation according to ENISO 11137-2

* Polypropylene(PP) Hinged Rack : Autoclavable at 121 °C, Robust, Sturdy and Reusable

* Rack is Printed with Volume Range, Lot Number * Stackable

* with Transparent Lid

AB.P10040 Tip, Low Retention, Racked Set, Sterile, Graduated, 0.2~10 μl

AB.P10041 , 0.2~10 μl , Extended

AB.P10042 , 2~200 μl , Bevelled-type

AB.P10044 , 2~300 μl

AB.P10045 , None-Graduated, 100~1,000 μl

Pk.	Price, ₩	Cs.	Price, ₩
1rack	5,960	10rack	55,120
1rack	5,960	10rack	55,120
1rack	5,700	10rack	52,740
1rack	6,530	10rack	60,380
1rack	6,470	10rack	59,780



(4) Refill Pack of Pipettor Tip for Empty Box, 0.2~300 μl

* Can be directly Loaded in the Box

* Easy to Load and Remove into Boxes

* Can be Autoclaved when Racked

* Rack is Printed with Volume Range, Lot Number

* Save Time & Cost

AB.P10060 Tip, Low Retention, Refill Pack, Graduated, 0.2~10 μl

AB.P10061 , 2~200 μl , Bevelled-Graduated

AB.P10063 , 2~300 μl

Cs.	Price, ₩
96pcs × 12refilled rack	41,670
96pcs × 10refilled rack	36,550
96pcs × 10refilled rack	42,810



Articles	Cat. No	Description
----------	---------	-------------

ABDOS® *LAST DROP*™ Sterile Low Retention Filter Tip, Hinged Rack Set of 96pcs, for Minimal Sample Loss, 0.2~1,000µl **NEW**
 Ideal for Biological Lab, DNase · RNase · Pyrogen-Free, Stackable, Leak-proof, 고정밀 멸균 필터 팁, 시료손실 최소화



- **Micro Pipettor Tips(0.2~1,000µl) Compatibility** : Axygen®, Biohit®, Brand®, Eppendorf®, Thermo Finnpipette®, Gilson®, Labnet®, Nichiryo®, Vistalab®, Wheaton-Socorex®
- **How to Reduce Sample Retention** : ① High Grade Resin Technology & Additives Engineering for Low Binding Surface, ② Diamond Polishing for Enhance Low Binding, ③ Injection Moulding Process
- **Production and Individual Packaging according to Clean Room 8**
- **Optimal Surface for Dispensing Minimal Sample Loss of Highly Viscous Liquids or Samples Containing Detergent**
- **Minimum Retention with Viscous Liquid thus Reducing Sample Retention Save on Costly Reagents**
- * Can Download the Certificate from '<http://www.abdoslifesciences.com>' with Product Code and Lot Number
- * Manufactured from Ultra Pure USP Class VI Certified Virgin Polypropylene to Ensure the Highest Quality
- * Proprietary Pure Porous Hydrophobic PE Filter helps us to Recover Contamination Free
- * Polypropylene(PP) Rack : Autoclavable at 121 °C

AB.P11061	Sterile Filter Tip, Low Retention, Graduated, 0.2~10µl	1rack	9,310	10rack	86,160
AB.P11063	, 0.2~10µl, Extended	1rack	9,310	10rack	86,160
AB.P11065	, 2~20µl	1rack	9,310	10rack	86,160
AB.P11069	, 2~100µl	1rack	9,310	10rack	86,160
AB.P11073	, 2~200µl	1rack	9,310	10rack	86,160
AB.P11075	, 2~300µl	1rack	9,310	10rack	86,160
AB.P11077	, Non-Graduated, 100~1,000µl	1rack	10,740	10rack	99,350

Pk.	Price, ₩	Cs.	Price, ₩
1	9,310	10	86,160
1	9,310	10	86,160
1	9,310	10	86,160
1	9,310	10	86,160
1	9,310	10	86,160
1	9,310	10	86,160
1	10,740	10	99,350



3D cell culture plate

Biofil® JET CellSCAFFOLD™ PS Treated 3D Cell Culture Plate, 6 · 12 · 24 Wells With Scaffold Insert, 3D Channel, γ -Sterile, Individual Package, 3D 셀 컬처 플레이트 NEW

■ **3D Cell Culture Plate is Structured with 3-dimensional Channels, and has Extremely High Connectivity, Facilitating the Transmission of Nutrients, the Consistency of Metabolic Activity and the Accuracy of Culture Results in 3D Cell Culture**

- * Made of Polystyrene with Wire Diameter of 500 μ m and Pore Width of 260 μ m, High Regularity
- * 3D Cell Culture Simulates the 3-dimensional Structure of the Cells in Animals and the Human Body to the Maximum Extent, Providing an Ideal Environment for the Interaction between Cells
- * Polystyrene-made, Cytokine and Growth Factor Resistant, Easy cell Secretion collection, Time-saving and Free from Extra Separating Steps * Open Pores with High Connectivity, Facilitating Nutrient Absorption and Metabolism
- * 3D Scaffold with Larger Surface Area * Non-pyrogenic & DNase/RNase-free

<L1>

Cat. No.	Well Q'ty	Scaffold Insert Q'ty	Scaffold Dimension (mm)	Surface Area (cm ²)	Pk. Price, ₩	Cs. Price, ₩
J1.P032.006	6	3	33.5×1.6	143	1ea 23,140	8ea 168,210
J1.P032.012	12	6	21.0×1.6	113	1ea 23,140	8ea 168,210
J1.P032.024	24	12	15.0×1.6	115	1ea 23,140	8ea 168,210

Articles	Cat. No	Description
----------	---------	-------------



에어 펌프, Air Hand Pump, Compact Heavy-duty CHINA

* Use : For Bicycle, Motorcycle, Play Equipment, etc. * Stepping Hand : Air Can Hold Less Power.
 ■ 작동이 쉽게 설계되어 있음. ■ 각종 노즐이 같이 포함 ■ 구기류 및 물놀이용 튜브도 사용 가능

		<B3>
(1) 길이 310mm	0309-652 Air Hand Pump "XYB-157", φ30×h310mm	Ea. Price, ₩ 5,620
(2) 길이 435mm	0309-653 Air Hand Pump "XYB-164", φ30×h435mm	Ea. Price, ₩ 5,260

, Barrel 배럴펌프

KDY PE 수동 펌프 KOREA
Siphon Hand Pump for Liquid/Kerosene

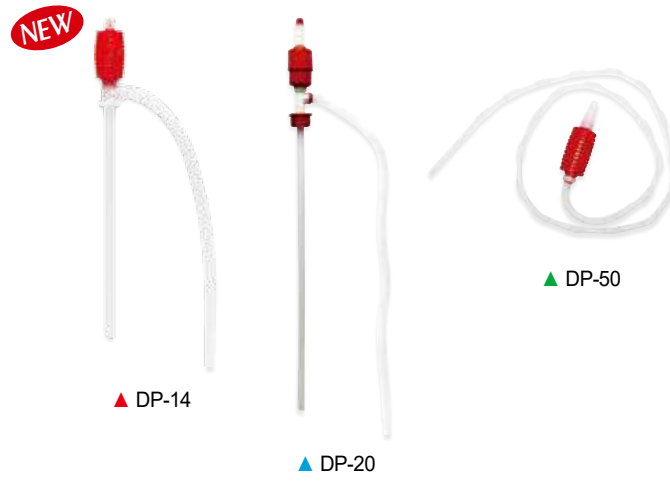

DP-14, DP-15, DP-20, DP-25
 ■ 수동압축식
 ■ 부식 및 독성이 없는 플라스틱 재질(주재질 : P.E)
 ■ 적용 액체 : 등유, 경유, 알코올성 음료, 물 등 **⚠ 주의사항**
 ■ 식수용은 불가

DP-50
 ■ 수동압축식 롱호스타입 ■ 부식 및 독성이 없는 플라스틱

	흡입관길이/굽기(mm)	중량(g)	분당 토출량(l/min)	기타
DP-14	385/15	64	7	일반용
DP-15	425/25	149	12	일반용
DP-20	875/22	300	17.5	드럼용
DP-50	1,685/12	70	4	일반용

ORDER NO.	MODEL NO.	PRICE, ₩ Ea.	규격	총길이(mm)	포장단위 Ea. / Pk.
▶ 0484-636	DP-14	1,370	소	530	1 / 10
▶ 0484-637	DP-15	3,680	중	610	1 / 10
▶ 0484-638	DP-20	4,650	대	1,125	1 / 10
▶ 0487-853	DP-50	4,120	-	1,823	1 / 50

KDY PE 케미칼 수동 펌프 KOREA
Chemical Siphon Hand Pump

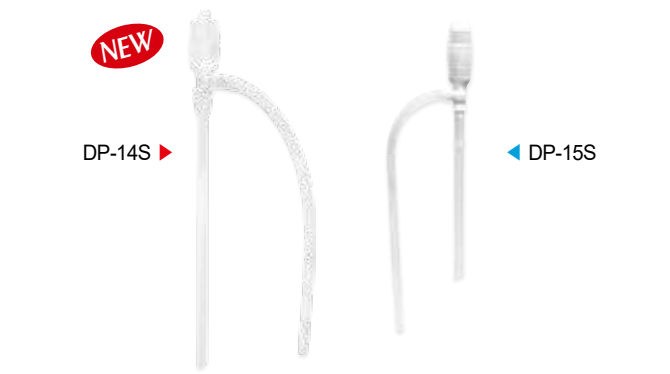

■ 수동식 압축 타입 ■ 부식 및 독성이 없는 플라스틱 재질(주재질 : P.E)
 ■ 신나, 톨루엔, 산성액체 35%(질산, 염산, 황산, 초산), 물 등 약산, 약알칼리에 사용 가능 펌프

	흡입관길이/굽기(mm)	중량(g)	분당 토출량(l/min)	기타
DP-14S	385/15	68	7	일반용
DP-15S	425/25	149	12	일반용, 원터치 스톱
DP-16-1S	425/25	160	12	일반용
TI-901S	850/25.5	390	21	드럼용

ORDER NO.	MODEL NO.	PRICE, ₩ Ea.	총길이(mm)	포장단위 Ea. / Pk.
▶ 0484-641	DP-14S	2,230	530	1 / 10
▶ 0484-640	DP-15S	4,470	610	1 / 24
▶ 0484-642	DP-16-1S	4,470	650	1 / 24
▶ 0484-643	TI-901S	10,790	1,150	1 / 6



KDY 수족관 펌프, Aquarium Cleaner Pump KOREA

■ 수동압축식 흡입타입 ■ 물고기에 영향을 주지 않고, 수족관 물 교체시 사용 ■ 사이펀원리에 의한 자동토출

	중량(g)	분당 토출량(l/min)		
DP-40	100	5.5		
ORDER NO.	MODEL NO.	PRICE, ₩ Ea.	총길이(mm)	포장단위 Ea. / Pk.
0487-854	DP-40	5,190	1,512	1 / 50

Articles

Cat. No

Description

NEW



드럼 펌프, Drum Pump

KOREA

주의사항

- 사용금지액 : 아세톤, 벤젠, 크로솔, 페놀 등
- 대용량 레버식 펌프
- 사용이 편리하고 한번에 500ml 이상 토출 가능
- 등유, 디젤오일, 바이오디젤, 윤활유 등에 사용
- 무부식, 무독성, 플라스틱 재질로 수동식 석션 타입

	흡입관길이/굵기(mm)	분당 토출량(1회)
DLP-530	690/980	10회 500ml

<B3>

ORDER NO.	품목	MODEL NO.	PRICE, ₩ Ea.	총길이(mm)	포장단위 Ea. / Pk.
0484-635	수동식 레버펌프	DLP-530	38,230	980	1 / 10

NEW



배터리 펌프, Battery Operated Pump

다국적

- 배터리 : D SIZE × 2EA(불포함)
- 호스길이 : 600mm
- 사용가능액체 : 석유, 등유, 경유, 저점도 오일, 물 등
- 경량형으로 휴대간편



	흡입관길이/굵기(mm)	중량(g)	분당 토출량(l/min)	기타
KBP-4013	385/32	200	10	반자동

<B3>

ORDER NO.	MODEL NO.	PRICE, ₩ Ea.	총길이(mm)	포장단위 Ea. / Pk.
0522-568	KBP-4013	10,200	610	1 / 25

, Bottle-Top 바틀-탑



오일펌프, Oil Pump

KOREA

NEW



(1) 직선 노즐형



(2) 자바라식 노즐형

ORDER NO.	MODEL NO.	PRICE, ₩ Ea.	전장(mm)	용량(cc)	포장단위 Ea. / Pk.
(1) 0248-106	OP-25(소)	5,600	130	250	
0248-105	OP-40(중)	6,340	135	400	1 / 20
0248-104	OP-65(대)	6,930	170	650	
(2) 0248-110	JP-25(소)	9,120	190	250	
0248-109	JP-40(중)	10,110	190	400	1 / 20
0248-108	JP-65(대)	10,980	190	650	

<B3>

Articles	Cat. No	Description
----------	---------	-------------

SciLab® ID-Color™ 81 & 100 hole Cardboard Box, for 0.5~5ml Cryovials/Microtubes, with PP Post-style Divider and Hinged Lid
 Ideal for ULT Freezer Box and LN₂ Freezing, Waterproof · Alphanumeric, -196℃ + 121℃, 81 & 100홀 판지 보관박스 **NEW**



- * Ideal for Liquid Nitrogen Storage
- * Made of Durable Cardboard with a Waterproof Coating
- * Alphanumeric Index on the Lid, Bottom and 4 Side enables Quick and Easy Identification of Sample
- * SL.Box9101 & SL.Box9102 : 5 Color - Blue / Green / Red / White / Yellow Assorted.
- * Temperature Range : -196℃ + 121℃ in Gas Phase
- * Polypropylene(PP) Post-style Divider

SL.Box9100	Cardboard Box, 100 holes × φ 12mm, 133 × 133 × h36mm, Blue
SL.Box9101	, 81 holes × φ 13mm, 133 × 133 × h52mm, Assorted
SL.Box9102	, 100 holes × φ 12mm, 133 × 133 × h52mm, Assorted
SL.Box9103	, 81 holes × φ 13mm, 133 × 133 × h52mm, Blue

<L1>			
Pk.	Price, ₩	Cs.	Price, ₩
5ea	33,060	4pk	122,400
5ea	33,060	4pk	122,400
5ea	33,060	4pk	122,400
5ea	38,880	4pk	143,990

Post-style Divider

SciLab® PC 100-hole Freezer Box, for 1.5/2ml Cryovials/Microtube, with Drain Holes and Air Vents, 133 × 133 × h52mm **NEW**
 Ideal for ULT Freezer Box and LN₂ Freezing, Numbered Grid Lid, with 100 holes φ 11 & 12mm, PC 100홀 프리저 박스



- * Made of Polycarbonate(PC) ; Chemically Resistant to alcohols and Organic Solvents
- * Can be repeatedly Frozen and Thawed
- * Boxes with Numbered Grids for Sample Identification
- * Suitable for Storage in Freezers or Liquid Nitrogen
- * SL.Rac3781 : 5 Color - Blue / Green / Red / White / Yellow Assorted.
- * Compatible with 0.5ml, 1.5/2.0ml Microtubes and Cryogenic Vials
- * Drain Holes and Air Vents Minimize Condensation
- * Temperature Range: Stable from -196℃ to 121℃ in Gas Phase

SL.Rac3781	Box, Freezer, PC, 100 holes φ 11mm, 133 × 133 × h52mm, Assorted Color
SL.Rac3783	Box, Freezer, PC, 100 holes φ 12mm, 133 × 133 × h52mm, Blue

<L1>			
Pk.	Price, ₩	Cs.	Price, ₩
5ea	61,240	4pk	226,800
3ea	62,210	4pk	230,390

, Drying



의류 건조대, 접이식, Foldable Apparel Dry Rack

KOREA

- All Stainless-steel
- 접이식으로 보관 편리.
- 자유로운 각도조절.

0502-015	의류건조대, 올스텐 1단, "931478", 1,600 × 540 × 1,190
0502-017	, 올스텐 2단, "931476", 1,600 × 540 × 1,190

<B3>		
Ea.	Price, ₩	
	61,750	
	70,870	

, Test Tubes



Biofil® PP 25-holes Centrifuge Tube Rack, for 15 & 50ml Conical-bottom Centrifuge Tube
 With Member-Numeric Index, Stable-base, Autoclavable, 125/140℃, PP 15 & 50ml 원심관용 랙 **NEW**

- Manufactured in a Class 100,000 Room Environment
- Manufactured under ISO13485:2016 and ISO9001:2015 Quality Management System
- * Made of Polypropylene(PP) ; Autoclavable at 121℃ and Freezable to -80℃
- * DNase/RNase Free and Non-pyrogenic

(1) PP Rack for 15ml Conical-bottom Centrifuge Tube

J1.CFR001.015	Rack, 25-Holes × φ 17mm, 154 × 127 × h32 mm, Light Green
J1.CFR003.015	, White

<L1>			
Pk.	Price, ₩	Cs.	Price, ₩
5ea	14,900	10pk	135,390
5ea	14,900	10pk	135,390

(2) PP Rack for 50ml Conical-bottom Centrifuge Tube

J1.CFR001.050	Rack, 25-Holes × φ 29mm, 233 × 191 × h32 mm, Light Green
J1.CFR003.050	, White

<L1>			
Pk.	Price, ₩	Cs.	Price, ₩
5ea	16,560	10pk	150,430
5ea	16,560	10pk	150,430

Kern® Popular Portable Handheld Refractometer, Measurement of Sugar and Salt, Compact Size **NEW**

With Wide Application Scopes, 휴대용 굴절계, 당도 및 염도 측정



- Supplied by Kern® in Germany ■ 자동 온도보정 기능으로 정확한 당도 및 염도 측정 가능
- The Handy and Robust Design Allows the Easy, Efficient and Sustainable Use in Every Life
- * The Optical System and the Prism Cover Made of Special Material which Allows a Low-Tolerance Measuring
- * The Models Marked with "ATC" have an Automatic Temperature Compensation which Enables Accurate Measurement at Different Ambient Temperatures (10°C~30°C)
- * Measurement Temperature without ATC : 20°C
- * Dimensions (W×D×H) & Weight : 205×75×h55mm & Approx. 200g
- ▶ Complete Set with : ① Refractometer, ② Storage Box, ③ Pipette, ④ Tools, ⑤ Cleaning Tissue, ⑥ Calibration Liquid

(1) Sugar ; Suitable for the Measurement of the "BRIX" Value

- * Determine the Sugar Content in Food, Especially in Fruit, Vegetables, Juice and Soft Drinks
- * Serve for Monitoring Processes in the Industry (Coolant Monitoring, Oils, Lubricants and Fats).

Specifications & Ordering information

<L1>

Cat. No.	Scales	Measuring Range	Division	ATC	Set. Price, ₩
KE.ORA.20BA	Brix	0 ~ 20 %	0.1 %	●	164,660
KE.ORA.32BA	Brix	0 ~ 32 %	0.2 %	●	164,660
KE.ORA.62BA	Brix	28 ~ 62 %	0.2 %	●	164,660
KE.ORA.82BB	Brix	45 ~ 82 %	0.5 %	●	154,980
KE.ORA.80BB	Brix	0 ~ 80 %	0.5 %	●	154,980

(2) Salt ; Suitable For the Measurement And Concentration Control of the Mass

- * Fraction of Natrium Chloride in Water as well as of the Content Of NaCl (Salt) in Water.
- * Applications for Food industry, Restaurants, Large-scale Catering Establishment and Aquaristic.

Specifications & Ordering information

Cat. No.	Scales	Measuring Range	Division	ATC	Set. Price, ₩
KE.ORA.1SA	Salinity Specific Gravity	0 ~ 100 ‰ 1,000 ~ 1,070 sg	1 ‰ 0.001 sg	●	164,660
KE.ORA.2SA	Salt (NaCl)	0 ~ 28 %	0.2 %	●	164,660
KE.ORA.3SA	Salt (NaCl) Brix	0 ~ 28 % 0 ~ 32 %	0.2 % 0.2 %	●	164,660

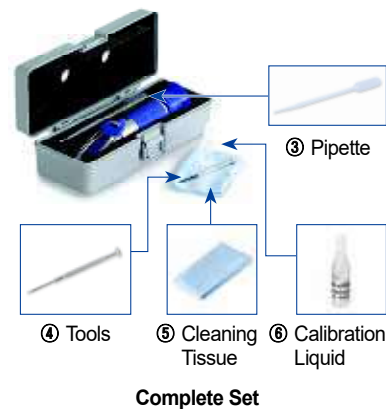

Kern® Expert Handheld Refractometer, Measurement of Brix and Refractive Index **NEW**

With a Special Large Measuring Range & Large Divided Scales, 전문가용 측정범위 조정형 굴절계, 당도 및 굴절률 측정

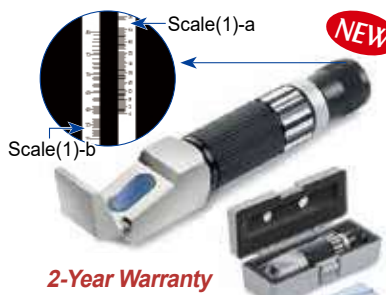

- Supplied by Kern® in Germany ■ 넓은 범위의 당도 및 굴절률 측정에 적합
- Thanks to Adjusting Wheel Measuring Range, Suitable for Determining the Refractive index of a Special Large Measuring Range
- With a Special Large Measuring Range for the Refractive Index and Large Divided Scales for the Measurement and Clear Reading of Brix Values
- * The Optical System and the Prism Cover are Made of Special Material which Allows a Low Tolerance Measuring.
- * Dimensions of the Box : 205×75×h55mm * Net Weight Approx. 400g / 600g
- * Product Length : Approx.180mm / 200mm
- * Measurement Temperature without ATC (Automatic Temperature Compensation) : 20°C
- * If the Temperature Deviates from 20°C, Correct the Measured Result using the Corresponding Value from the Temperature Correction Table (Please Refer to Manual, Can be Downloaded from "https://www.kern-sohn.com/en")
- ▶ Complete Set with : ① Refractometer, ② Storage Box, ③ Pipette, ④ Tools, ⑤ Cleaning Tissue, ⑥ Calibration Liquid for KE.ORA.80BE



Specifications & Ordering information

<L1>

Cat. No.	Scales	Measuring Range	Division	Set. Price, ₩
(1) KE.ORA.80BE	Brix	Scale(1)-a, 0 ~ 50 % Scale(1)-b, 50 ~ 80 %	0.5 % 0.5 %	271,190
(2) KE.ORA.90BE	Brix	Scale(2)-a, 0 ~ 42 % Scale(2)-b, 42 ~ 71 % Scale(2)-c, 71 ~ 90 %	0.2 % 0.2 % 0.2 %	571,430
(3) KE.ORA.1RE	Refractive Index	Scale(3)-a, 1.333 ~ 1.405 nD Scale(3)-b, 1.405 ~ 1.468 nD Scale(3)-c, 1.468 ~ 1.517 nD	0.005 nD 0.005 nD 0.005 nD	571,430

Articles	Cat. No	Description
----------	---------	-------------

Kern® Popular Digital Handheld Refractometer, Measurement of Brix and Refractive Index NEW

Ideal for Universal Application, Easy Handling & Sturdiness, 휴대용 디지털 굴절계, 당도 및 굴절을 측정



2-Year Warranty

Complete Set

- **Supplied by Kern® in Germany**
- **These Refractometers are Accurate and Universal Maintenance Free Digital Handheld Refractometers**
- * The Handy and Robust Design Allows the Easy, Efficient and Sustainable Use in Every Life
- * The Integrated Automatic Temperature Compensation (ATC) at ORF45BE Means that you can Work Easily and Quickly, as you do not have to Manually Convert the Measurement
- * Factory Calibration Guarantees Immediate use for Accurately Measuring your Sample
- * Measurement Temperature : 10°C~40°C * Dimensions (W×D×H) & Weight : 145×67×40mm & Approx. 200g.
- * Standard Batteries : 2×1.5V AAA, Operating Time : Approx. 5,000 Measurements
- * Minimum Sample Volume : 2~3 Drops * Automatic Energy Management (AUTO-OFF After 90 Seconds)
- ▶ **Complete Set with :** ① Refractometer, ② Storage Box, ③ Pipette, ④ Tools, ⑤ Cleaning Tissue, ⑥ Calibration Liquid, ⑦ Leather Bag



Specifications & Ordering information

<L1>

Cat. No.	Scales	Measuring Range	Accuracy	Division	ATC	Price, ₩
KE.ORF.45BE	Brix	0 ~ 45 %	± 0.2 %	0.1 %	●	561,750
KE.ORF.45RE	Refractive Index	1.3330 ~ 1.4098 nD	± 0.0003 nD	0.0001 nD	-	561,750

Kern® Premium Digital Handheld Refractometer, Multi-Application, Measurement of Sugar · Salt · Refractive Index, IP65 Waterproof With Compact Size Body, Large Color TFT Display, 프리미엄 / 방수형 디지털 휴대용 굴절계, 당도 · 염도 · 굴절을 측정



2-Year Warranty

- **Supplied by Kern® in Germany**
- **This Refractometer is Accurate and Universal Maintenance Free Digital Handheld Refractometers**
- **The Typical and Practical Design is Suitable for a Quick and Convenient Everyday Use, Auto-OFF**
- **The Large, Easy-to-read TFT Color Display with Integrated Temperature Display Supports the User to Reliably Determine the Measurement**

- * The Instrument Comes with an Optimized Software that can Show a Result in Different Scales
- * The Integrated Automatic Temperature Compensation (ATC), Avoids the Manual conversion of the Measurement.
- * This Allows a Quick and Efficient Usage of the Instrument. * IP65 : Protected Against Dust and Water Splashes
- * Dimensions(W×D×H) & Weight : 145×67×40mm & Approx. 200g. * Measurement Temperature : 5°C~40°C
- * Standard Batteries : 2×1.5V AAA, Operating Time : Approx. 3,750 Measurements
- * ATC (Automatic Temperature Compensation), does not Apply to the Refraction Index Scale
- * Minimum Sample Volume : 2 ~ 3 Drops * Automatic Energy Management (AUTO-OFF After 90 Seconds)
- ▶ **Complete Set with :** ① Refractometer, ② Storage Box, ③ Pipette, ④ Tools, ⑤ Cleaning Tissue, ⑥ Calibration Liquid, ⑦ Leather Bag

(1) Sugar (Brix & Refractive Index) ; Suitable for the Measurement of the "BRIX" Value

- * Determine the Sugar Content in Food, Especially in Fruit, Vegetables, Juice and Soft Drinks
- * Serve for Monitoring Processes in the Industry (Coolant Monitoring, Oils, Lubricants and Fats).
- * The Display can be Switched to Show the Refractive index.

<L1>



Complete Set

Cat. No.	Scales	Measuring Range	Accuracy	Division	Price, ₩
KE.ORF.45BM	Brix	0~45 %	± 0.2 %	0.1 %	658,600
	Refractive index	1.3330~1.4098 nD	± 0.0003 nD	0.0001 nD	
KE.ORF.92BM	Brix	58~92 %	± 0.2 %	0.1 %	716,710
	Refractive index	1.4370~1.5233 nD	± 0.0003 nD	0.0001 nD	
KE.ORF.85BM	Brix	0~85 %	± 0.2 %	0.1 %	765,120
	Refractive index	1.3330~1.5100 nD	± 0.0003 nD	0.0001 nD	

(2) Expert (Refractive Index) ; for Extra Measuring Range

Cat. No.	Scales	Measuring Range	Accuracy	Division	Price, ₩
KE.ORF.1RS	Refractive Index	1.3330 ~ 1.5400 nD	± 0.0005 nD	0.0001 nD	832,930

(3) Salt (Brix & Salt & Refractive Index) ; Suitable to Determine NaCl (Salt) Concentration in Water NEW

- * Applications for Food industry, Restaurants, Large-scale Catering Establishment and Canteens.

Cat. No.	Scales	Measuring Range	Accuracy	Division	Price, ₩
KE.ORF.3SM	Brix	0~45 %	± 0.2 %	0.1 %	678,560
	Salt (NaCl)	0~28 %	± 0.2 %	0.1 %	
	Refractive index	1.3330~1.4100 nD	± 0.0003 nD	0.0001 nD	



IP65 : Protected Against Water

	Ea. Price, ₩
KE.ORD.A2104 Spare ; Leather Bag for Digital Refractometer	36,830
KE.ORFA1005 Optional ; Prism Cover for Digital Refractometers	48,440
KE.ORA.A1001 ; Calibration Liquid, Distilled Water, 2.5ml	36,830
KE.ORA.A1006 , Triethyl Citrate, 2.5ml	36,830

Kern® ABBE Refractometer, High-Precision Measurement of Brix & Refractive Index, Ideal for Pharmacy · Laboratory · Industry NEW
 With a Digital Thermometer, Use for Liquid · Solid · Pasty Samples, 아베(ABBE) 굴절계, 디지털 온도계 포함



- Supplied by Kern® in Germany
- 편리하고 액체나 고체의 굴절률을 신속 정확하게 측정, 특히 약국·실험실 등에 널리 사용, 디지털 온도계 사용으로 높은 신뢰성
- A Simple yet Highly Reliable ABBE Refractometer with a Digital Thermometer
- The Integrated Scale Allows the Use in Different Applications and Provides the Best Possible Security to Read the Measurement Result Accurately

* Can be Used to Quickly and Accurately Determine the Refractive Index of Liquid, Solid, and Pasty Samples.
 * Scope of Application : Pharmacy, Laboratories, Sugar · Beverage · Food · Chemical · Oil Industry
 * Measurement Temperature : 20℃

* Dimensions (W×D×H) & Weight : 180×90×240mm & Approx. 1950g

▶ Complete Set with : ① Refractometer, ② Thermometer, ③ Tools, ④ Cleaning Tissue, ⑤ Calibration Block, ⑥ Contact Liquid

Specifications & Ordering information

<L1>

Cat. No.	Scales	Measuring Range	Accuracy	Division	Price, ₩
KE.ORT.1RS	Brix Refractive Index	0 ~ 95 % 1.3000 ~ 1.7000 nD	±0.1% ±0.0002 nD	0.25 % 0.0005 nD	1,336,550

Accessories

- KE.ORA.A2266 Spare ; Digital Thermometer 0℃~50℃
- KE.ORA.A2267 ; Calibration Block
- KE.ORA.A1102 Optional ; Aluminium Suitcase, 310×120×240mm, 1300g
- KE.ORA.A1107 ; Contact Liquid, Alpha-Bromonaphthalene, 1.65nD, 2.5ml
- KE.ORA.A3001 , Diiodomethane "Pro", 1.79nD, 2ml

Ea.	Price, ₩
	116,250
	77,490
	154,980
	48,440
	67,810

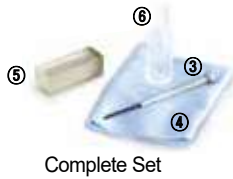

Complete Set



② With a Digital Thermometer



Scale for KE.ORT.1RS



Optional Aluminium Suitcase

Articles	Cat. No	Description
----------	---------	-------------

Alpicool® -20°C +20°C Multi-use Low Temperature Fridge/Freezer, Single & Dual Temp Controlled, with Side Handle, 36Lit NEW
 With AC/DC Converter, Temp Display & Control, Drain Valve, LED Light, 이동식 냉장/냉동고, 듀얼 온도조절



Dual Temp-type Portable Fridge/Freezer

- 터치식 디스플레이로 간단하게 온도조절 가능
- 저장공간에 탈부착식 칸막이가 있어 탈착시에는 냉장 또는 냉동으로만 사용 가능
- 어플리케이션으로 스마트폰과 연결하여 온도조절 가능
- Easy to Move with Heavy-duty Handle & wheels
- Temperature Controllable by Connecting to Applications : Download the Alpicool App from the Play Store or App Store.

* Dual Compartment : Individual Temperature Adjustable * AC to DC Adaptor included
 * Built in Drain Valve, LED Light, USB Port for Charge * Low Noise up to 45dB
 * Anti Vibration Design * Powerful Chilling Performance : -20°C +20°C

Specifications & Ordering information

<B5>

Spec.	Model	"T36" Dual Temp-type
Temperature Range		-20°C +20°C
Capacity		36Lit / 2 Room (Independent Control)
Cooling System		DC Compressor
Display		Digital LED
Noise Level		<45dB
Handle		Drawbar, Heavy Duty Handles
Dimension		723×360×368mm, 14Kg
Electrical Reqts.		60W
Electric Reqts.		AC 100-240V or DC 12V / 24V
Cat. No.		DH.Ref3001
Price, Each. ₩		403,200



Dual Temp. Controlled



LED Light

AC, DC Adaptor

External Battery

Optional Battery

* Max. Using Time(Full Charge) : 4hr

	Ea.	Price, ₩
DH.Bat7001 DC12V Battery, Rechargeable, DC12V, 90×160×h75mm		174,720

Alpicool® -20°C +20°C Multi-use Low Temperature Fridge/Freezer, with Adjustable Back Handle, 42Lit NEW
 With AC/DC Converter, Temp Display & Control, Drain Valve, LED Light, 이동식 냉장/냉동고



Collapsible Handle-type Portable Fridge/Freezer

- 터치식 디스플레이로 간단하게 온도조절 가능
- 어플리케이션으로 스마트폰과 연결하여 온도조절 가능
- Easy for Moving, Adjustable Collapsible Handle, Smooth Large Wheels
- Temperature Controllable by Connecting to Applications : Download the Alpicool App from the Play Store or App Store.

* Built in Drain Valve, LED Light, USB Port for Charge, Bottle Opener
 * Release Hands : Hanging Position, Stably Stuck for Phone Holder & Drink Groove
 * Adjustable 3-Lever Collapsible Handle * Low Noise up to 45dB
 * Powerful Chilling Performance : -20°C +20°C * Anti vibration design

Specifications & Ordering information

<B5>

Spec.	Model	"NX42" Collapsible Handle-type
Temperature Range		-20°C +20°C
Capacity		42Lit×1Room
Cooling System		DC Compressor
Display		Digital LED
Noise Level		<45dB
Handle		Adjustable 3-Lever Collapsible Handle
Dimension		689×412×465mm, 17.6Kg
Electrical Reqts.		60W
Electric Reqts.		AC 100-240V or DC 12V / 24V
Cat. No.		DH.Ref3005
Price, Each. ₩		336,000



LED Light

AC, DC Adaptor

External Battery

Optional Battery

* Max. Using Time(Full Charge) : 4hr

	Ea.	Price, ₩
DH.Bat7001 DC12V Battery, Rechargeable, DC12V, 90×160×h75mm		174,720

NEW

Medicaluse



Single Hook Retractor, Stainless-steel 410, L160mm, *Medicaluse* NEW

Sharp- & Blunt-type, 2~4 Prong, **훅 리트렉터**, 의료용, 비부식

- **Stainless-steel 410** : 비부식, 고강도, 고경도, 내약품성
- 환부를 벌리는데 사용
- **Rust-proof, High-Strength/Hardness, Chemical Resistance**
- * Used to Retract Surface Tissue

(1) Sharp-type, 2~4 Prongs 

- DM.04.1065 Hook Retractor, Stainless-steel, 2Prong, Sharp, L160mm
- DM.04.1066 , 3Prong, Sharp, L160mm
- DM.04.1067 , 4Prong, Sharp, L160mm

Ea.		Price, ₩
		<M1>
		7,870
		7,870
		7,870

(2) Blunt-type, 2~4 Prongs 

- DM.04.1070 Hook Retractor, Stainless-steel, 2Prong, Blunt, L160mm
- DM.04.1071 , 3Prong, Blunt, L160mm
- DM.04.1072 , 4Prong, Blunt, L160mm

Ea.		Price, ₩
		7,870
		7,870
		7,870

NEW

Medicaluse



Volkman Retractor, with Ring Handle, L215mm, *Medicaluse* NEW

With Blunt 2~4 Prong, Stainless-steel 410, **볼크만 리트렉터**, 의료용, 비부식

- **Stainless-steel 410** : 비부식, 고강도, 고경도, 내약품성
- 환부를 벌리는데 사용하며, 주로 정형외과에서 사용
- **Stainless-steel 410** : Rust-proof, High-Strength/Hardness, Chemical Resistance
- * Used to Retract Tissue

- DM.04.1080 Retractor, Stainless-steel, Volkman, 2Prong, L215mm
- DM.04.1081 , 3Prong, L215mm
- DM.04.1082 , 4Prong, L215mm

Ea.		Price, ₩
		<M1>
		19,670
		19,670
		19,670

NEW

Medicaluse



Kocher Retractor, with Ergonomic Handle, L210mm, *Medicaluse* NEW

With L-Shaped Blade, Stainless-steel 410, **코카 리트렉터**, 의료용, 비부식

- **Stainless-steel 410** : 비부식, 고강도, 고경도, 내약품성
- 수술 부위의 시야 확보를 위해 조직이나 장기를 당겨 이동시키거나 고정하는 기구
- **Stainless-steel 410** : Rust-proof, High-Strength/Hardness, Chemical Resistance
- * Used to Retract Soft Tissues and Optimize the Surgical View in General Surgery Procedures

- DM.04.1085 Retractor, Stainless-steel, Kocher, Blade-58 × 11mm, L210mm

Ea.		Price, ₩
		19,670

NEW

Medicaluse



Senn-Muller Double-ended Retractor, L160mm, *Medicaluse* NEW

With Blunt 3-prong & L-Shaped Blade, Stainless-steel 410, **센 리트렉터**, 의료용, 비부식

- **Stainless-steel 410** : 비부식, 고강도, 고경도, 내약품성
- 절개구를 넓게 벌리거나 환부를 벌리는데 사용
- **Stainless-steel 410** : Rust-proof, High-Strength/Hardness, Chemical Resistance
- * Double-ended Retractor; One end is Blunt-3Prong, and the Other end is L-shaped Blade
- * Used to Retract Tissue

- DM.04.1088 Retractor, SS, Senn-Muller, Blunt-3Prong, Blade-23 × 7mm, L160mm

Ea.		Price, ₩
		9,840

NEW

Medicaluse

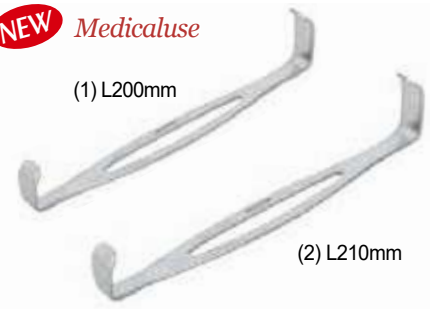

U.S Army Double-ended Retractor Set, L200 & 210mm, *Medicaluse* NEW

With L-Shaped Blade & Fenestrated Handle, Stainless-steel 410, **유에스 아미 리트렉터**, 의료용, 비부식

- **Stainless-steel 410** : 비부식, 고강도, 고경도, 내약품성
- 절개구를 넓게 벌리는데 사용하는 기구, 짧고 긴 블레이드를 가지고 있어 복부 수술뿐만 아니라 얼굴, 머리 등에 주로 사용
- **Stainless-steel 410** : Rust-proof, High-Strength/Hardness, Chemical Resistance
- * Used to Retract Shallow or Superficial Incisions From Small Wound to Abdoninal Surgery

- * 2ea × Retractor; (1) 2 Blade-40 × 15 & 26 × 15mm, L200mm
- (2) 2 Blade-42 × 15 & 32 × 15mm, L210mm

- DM.04.1090 Retractor, U.S Army, Stainless-steel, L200 & 210mm

Set.		Price, ₩
		<M1>
2ea		21,240

Articles

Cat. No

Description

Richardson-East Double-ended Retractor Set, with Central Ribbed Handle, L260 & 280mm, *Medicaluse* ^{NEW}
 With Concave-Shaped Blade, Stainless-steel 410, 리처드슨 이스트 리트렉터, 의료용, 비부식

NEW *Medicaluse*

(1) L260mm

(2) L280mm

- **Stainless-steel 410** : 비부식, 고강도, 고경도, 내약품성
- 수술 절개 부위나 상처 부위의 가장자리를 넓게 당길 때 사용하는 기구로 끝이 둥글어 조직을 손상 없이 당길 수 있음
- **Stainless-steel 410** : Rust-proof, High-Strength/Hardness, Chemical Resistance
- * Used to Retract Abdominal or Chest Incisions
- * Used for Holding Back Multiple Layers of Deep Tissue
- * 2ea × Retractor; (1) 2 Blade-36 × 28 & 28 × 20mm, L260mm
- (2) 2 Blade-63 × 52 & 50 × 40mm, L280mm

<M1>

DM.04.1093 Retractor, Stainless-steel, Richardson-East, L260 & 280mm

Set.	Price, ₩
2ea	35,400

Self-retaining *Weitlaner* Retractor, Stainless-steel 410, L140 & 165mm, *Medicaluse* ^{NEW}
 With Excurved 3 × 4 Prong, Sharp- & Blunt-type, Ratchet Locking Mechanism, 웨이트레이너 리트렉터, 자체유지기능, 의료용, 비부식

NEW *Medicaluse*

(1)

(2)

- **Stainless-steel 410** : 비부식, 고강도, 고경도, 내약품성
- 수술 시 절개 부위를 벌려 놓을 때 사용하며 자체 유지 기능이 있음
- **Stainless-steel 410** : Rust-proof, High-Strength/Hardness, Chemical Resistance
- * Used for Holding Back Tissue and Exposing Surgical Site
- * Ratchet Locking Mechanism allows the Retractor to Remain in Place

<M1>

DM.04.1095 (1) Self-retaining Retractor, Stainless-steel, Weitlaner, Sharp, L140mm**DM.04.1096** , L165mm**DM.04.1098** (2) Self-retaining Retractor, Stainless-steel, Weitlaner, Blunt, L140mm**DM.04.1099** , L165mm

Ea.	Price, ₩
	35,400
	43,260
	35,400
	43,260

*Medicaluse*

Self-retaining *Gelpi* Retractor, Stainless-steel 410, L175mm, *Medicaluse* ^{NEW}
 With Sharp Prong, Ratchet Locking Mechanism, 겔피 리트렉터, 자체유지기능, 의료용, 비부식

- **Stainless-steel 410** : 비부식, 고강도, 고경도, 내약품성
- 수술 시 절개 부위를 벌려 놓을 때 사용하며 자체 유지 기능이 있음
- **Stainless-steel 410** : Rust-proof, High-Strength/Hardness, Chemical Resistance
- * Used for Retraction of Deep and Superficial Tissues
- * Ratchet Locking Mechanism allows the Retractor to Remain in Place

<M1>

DM.04.1101 Retractor, Stainless-steel, Gelpi, Sharp, L175mm

Ea.	Price, ₩
	51,130

NEW



SB® Combination Square, with Tube-type Level, Multiuse L150~4000mm, 콤비네이션 스퀘어

■ **Made in Korea** * 45°, 90° 작업을 비롯하여 다양한 용도로 사용
* 금긋기 침이 내장되어 있어 철판에 표시가 가능

S3.CNS150 Combination Square, L150mm
S3.CNS300 , L300mm
S3.CNS400 , L400mm

<B4>

Ea.	Price, ₩
	10,970
	12,240
	15,260

KDY 콤파스, Compass

다국적

NEW



■ 중심사이 거리 측정
■ 원 반지름 크기 측정
■ 버니어 및 철직자 측정치 비교

<B3>

ORDER NO.	MODEL NO.	규격(mm)	PRICE, ₩ Ea.	포장단위 Ea. / Pk.
0470-374	KCO-150	150	10,790	1 / 12
0470-375	KCO-200	200	11,760	1 / 12
0470-376	KCO-250	250	13,240	1 / 12
0470-377	KCO-300	300	18,140	1 / 6

내경 파스, Internal Compass

KOREA

NEW



■ 물체나 관의 안지름을 재는 콤파스 타입의 자

<B3>

ORDER NO.	MODEL NO.	규격(INCH)	PRICE, ₩
0196-217	IC-6	6	9,410
0196-219	IC-8	8	12,550
0196-212	IC-10	10	14,710
0196-213	IC-12	12	16,770

외경 파스, External Compass

KOREA

NEW



■ 나 두께를 측정하는 공구

<B3>

ORDER NO.	MODEL NO.	규격(INCH)	PRICE, ₩
0114-570	OC-6	6	9,410
0114-572	OC-8	8	12,550
0114-573	OC-10	10	14,710
0114-574	OC-12	12	16,770

휠리(틈새) 게이지 [25매], Metric Feeler Gauge with 25 Strips

TAIWAN

NEW



구성(두께)

<B3>

세트수량 (25매수)	0.04, 0.05, 0.06, 0.07, 0.08, 0.09, 0.10, 0.15, 0.20, 0.25, 0.30, 0.35, 0.40, 0.45, 0.50, 0.55, 0.60, 0.65, 0.70, 0.75, 0.80, 0.85, 0.90, 0.95, 1.00mm			
ORDER NO.	MODEL NO.	PRICE, ₩ Ea.	규격(mm) 폭(W)×길이(L)	포장단위 Ea. / Pk.
0355-929	77335-25	9,360	13×85	1 / 50

NEW



(1) Laser Meter, 0.2~50m (2) Laser Meter, 0.2~120m

Komelon® Laser Meter, 50~120m, Waterproof IP65, 20Memories With Various Measuring Mode, Compact Slim-Type, 초소형 레이저 거리측정기

* General Purpose : Construction, Interior. * Memory Function : Final Value of 20
* Composed : Laser Meter, Pouch, AAA/1.5V Battery, User Guide. * Range & Accuracy : 0.2 ~ 120m, ±2mm
* Measuring Unit : m, ft, in, ft+in * Class 2 Laser (163-670nm, < 1mW) * Auto Power Off : 180 sec.

(1) 0.2~50m, Laser Meter

* Various Measuring Mode : Single Distance, Continuous, Area, Volume, +-, Pythagoras(2, 3point)
* with Pocket Clip, Tube Vial Level * Power : AAA(1.5V)×2Ea

<B4>

K5.LM25 Laser Meter, 0.2~50m, 48×27×h120mm, 96g

Ea.	Price, ₩
	61,600

(2) 0.2~120m, Laser Meter

* Various Measuring Mode : Single Distance, Continuous, Area, Volume, +-, Pythagoras(2, 3point), Level, Height
* Dustproof & Waterproof IP65 * Digital Angle Measuring (Accuracy : ±0.3°)
* Triangle Mount Available * Power : AAA(1.5V)×3Ea

K5.LM212 Laser Meter, 0.2~120m, 49×26×h115mm, 98g

Ea.	Price, ₩
	135,800

Articles

Cat. No

Description



SB® Walking Measure, Measuring Range 1cm~10,000m, ϕ 10 & 16cm / Single & Double wheel With Adjustable Handle, Durable, Carrying Bag, Foldable Stand, Adjustable Handle 48cm~105cm, 휠메저 **NEW**

- 강한 충격에도 견딜 수 있도록 내구성이 높은 기어방식의 카운터 장착
- 바퀴표면을 고정밀 연마 작업하여 측정거리 오차를 줄임
- 교통사고 스키드마크 확인 및 건축·토목·설비·배관 작업등 거리 측정
- * Reduced Measuring Distance Error with Wheel Surface Milled Precisely
- * High Durability in Tough Working
- * Adjustable Aluminum Handle 48cm~105cm
- * Easy to Carry and keep

S3.WM1K	(1) Walking Measure, 1cm~1,000m, ϕ 10cm Single wheel, L48~105cm, 500g
S3.WMD1K	(2) , ϕ 10cm Double wheel, L48~105cm, 600g
S3.WMD10K	(3) , 10cm ~ 10,000m, ϕ 16cm Double wheel, L48~105cm, 815g

<B4>	
Ea.	Price, ₩
	76,750
	83,420
	86,070



Komelon® L2m~5m Basic Measure Tape, Nylon Coated Steel Blade **NEW**
With Metal Belt Clip, Compact Size, Certified KS/JIS/CE, 표준형 줄자

- * Superior Internal Mechanism Provides Smooth Operation
- * Compact Design for Convenient Use. * Easy to Read High Visibility Printing

K5.KMC21.2	Basic Measure Tape, w13mm × L2m
K5.KMC21.3	, w16mm × L3.5m
K5.KMC21.5	, w16mm × L5m

<B4>	
Ea.	Price, ₩
	3,360
	5,880
	6,720



Komelon® L5m Jacket Magnetic Tape, Nylon Coated Steel Blade **NEW**
With Magnetic End Hook, Belt Clip, Measuring Holder, 자켓쟁이 줄자

- * High Durability due to 20% thicker (0.135mm) * Maximum Guaranteed Upright 2600mm
- * Back Side Printing for Precision Marking and Line Drawing
- * Repeat 407mm Pitch Mark for Woodworking

K5.KMC25RJT	Measuring Tape, Jacket, w25mm × L5m
--------------------	-------------------------------------

<B4>	
Ea.	Price, ₩
	11,070



Komelon® L7.5m Hi-grade Measure Tape, Nylon Coated Steel Blade **NEW**
With Metal Belt Clip, wrist Strap, Certified KS/JIS/CE, 전문가용 수동줄자

- * Certified KS, JIS, CE marked * Buttonless Manual Tape Measure for Professionals
- * Robust Metal Belt Clip and Black Hook * Special Nylon Coating for Abrasion Resistance
- * Including Buffer when Inserting Measure Tape

K5.KMC33	Hi-grade Measure Tape, w25mm × L7.5m
-----------------	--------------------------------------

<B4>	
Ea.	Price, ₩
	11,630



H6B/V

3M® Peltor Optime® Earmuff, up to 95 · 98 · 101 · 105 dB according to ANSI
Ideal for Use with Other Protection Equipment, Ultra-soft Ear Cushions, 귀덮개

- Optime number(95/98/101/105dB) means the max noise level in accordance with ANSI standard.
- Wide-range : NRR(Noise Reduction Rate) 21dB~30dB, up to TWA Max.105dB
- En Excellent Padded Foam Headband and Ultra-soft Ear Cushions
- Stainless-steel Wire and Earcup Pivot-points Construction : Highest Performance and Durability
- Good for Use with Other Protection Equipment of Hats/Shields/Spectacles/etc.
- Peltor Earmuff provides durable and effective hearing protection.



Liquid & Foam filled earmuff cushions contribute superior comfort, fit and hearing protection over safety glass.



Stainless steel headband with pad distributes weight for has a pad for low pressure fit.



Earcup pivot-points can tilt for optimum comfort and efficiency.



H10A

(1) for 30~105dB.



H10B

(2) for 29~105dB.

(1) "H10A" Earmuff, NRR 30dB, up to 105dB, Patented Dual Earcups

- * Patented twin-cup design for efficiency of NRR.
- * It provides ear protection of noise levels up to 105dB.

<B4>

Ea.	Price, ₩
	32,200

3M.03.5039 "H10A" Earmuff, 30~105dB

(2) "H10B" Earmuff, NRR 29dB, up to 105dB **NEW**

- * Fit Well with Most Helmets
- * Allows for Easy Use with Hard Hats

Ea.	Price, ₩
	36,400

3M.03.5141 "H10B" Earmuff, NRR 29~105dB



H10P3E

(3) for 27~105dB.



H7A

(4) for 27~101dB.

(3) "H10P3E" Earmuff, NRR 27dB, up to 105dB **NEW**

- * Easy cap-mount design
- * Cap Attached with Double-shell Technology to Provide Effective Hearing Protection

Ea.	Price, ₩
	32,200

3M.03.5142 "H10P3E" Earmuff, NRR 27~105dB

(4) "H7A" Earmuff, NRR 27dB, up to 101dB

- * Insulated earmuff is available.

Ea.	Price, ₩
	24,510

3M.03.5040 "H7A" Earmuff, 27~101dB



H7B

(5) for 26~101dB.



H9A

(6) for 25~98dB.

(5) "H7B" Earmuff, NRR 26dB, up to 101dB **NEW**

- * Stainless Steel Band Distributes Weight for Low-pressure It
- * Behind the Head Type

Ea.	Price, ₩
	30,110

3M.03.5143 "H7B" Earmuff, NRR 29~101dB

(6) "H9A" Earmuff, NRR 25dB, up to 98dB

- * Light weight
- * Patented twin-cup design for efficiency of NRR.

Ea.	Price, ₩
	20,720

3M.03.5041 "H7A" Earmuff, 25~98dB



H6A/V

(7) for 21~95dB.



H6B/V

(8) Behind the Head-style
21~95dB.

(7) "H6A/V" Earmuff, NRR 21dB, up to 95dB, Over the Head-style

3M.03.5042 "H6A/V" Over the Head-style, 21~95dB

Ea.	Price, ₩
	18,910

(8) "H6B/V" Earmuff, NRR 21dB, up to 95dB, Behind the Head-style

- * Useful to use with welding helmet.
- * Behind the head type.

Ea.	Price, ₩
	24,920

3M.03.5043 "H6B/V" Behind the Head-style, 21~95dB



H6P3E/V

(9) for 21~101dB.



X4A

(10) for 27~101dB.

(9) "H6P3E/V" Earmuff, NRR 21dB, up to 101dB **NEW**

- * Universal Mounting Attachment Fits Most Hard Hats
- * Ultra light

Ea.	Price, ₩
	21,000

3M.03.5144 "H6P3E/V" Earmuff, NRR 21~101dB

(10) "X4A" Earmuff, NRR 27dB, up to 101dB **NEW**

- * Twin Headband Design Helps Reduce Heat Buildup with Good Fit and Balance

Ea.	Price, ₩
	42,000

3M.03.5145 "X4A" Earmuff, NRR 27~101dB

Articles	Cat. No	Description
----------	---------	-------------



(1) Head Band type (2) Neck Band type



(3) Helmet Detached type

NEW

3M® PELTOR™ WS™ Litecom ProIII Headset, Two-way Communication, Bluetooth **NEW**
 Level Dependent Hearing Protection, Hands Free Operation, 무전기 내장형 전자감응 귀덮개/헤드셋, 블루투스

- 무전기가 내장되어 무선 통신(UHF주파수)이 가능한 헤드셋
- IP68 방수등급 마이크에 Noise Cancelling 기능이 탑재되어 고소음 환경에서 깨끗한 음성 송신가능
- Integrated Two-Way(Analog & DMR) Communication Radio



블루투스형

- * Built-in Programmable Two-way Communication Radio Allows for Clear
- * Hands-Free Communication in High Levels of Noise without Cumbersome Cables or Cords
- * The Headset Can Be Programmed to Use Up to 70 Unique Two-way Radio Channels
- * Available for Using Bluetooth
- * Ideal for Using in Tough for the Working Professional
- * Noise attenuating ear cups help provide hearing protection in environments with potentially hazardous noise.
- * Environmental Microphones for Level-Dependent Hearing Protection and Ambient Listening
- * Noise-Cancelling Waterproof Speech Microphone with Voice Operated Transmission (VOX) for Hands-Free Operation
- * Clear Communication in Noisy and Demanding Environments
- * Headset is available in Headband, Neckband and Hard Hat Attached Configurations

<B4>

Ea.	Price,₩
	1,820,000
	1,820,000
	1,820,000

- 3M.03.5161** (1) Headset, Head Band type, 28dB
3M.03.5162 (2) , Neck Band type, 28dB
3M.03.5163 (3) , Helmet Detached type, 24dB



(1) Head Band type (2) Neck Band type

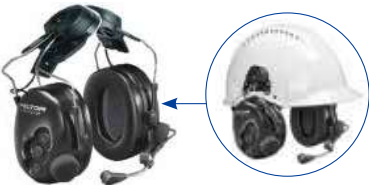

(3) Helmet Detached type

NEW

3M® PELTOR™ Tactical™ XP Flex Headset, with Noise Cancelling Mike & Level Dependent Function **NEW**
 무전기 연결형 전자감응 귀덮개

- 소음발생 현장에서 청력 보호와 동시에 대화/무전 통신 필요시 사용
- 사용하고 있는 무전기와 별도의 케이블을 연결하여 편리하게 사용 가능
- 주파수 대역별로 소리의 크기를 조절할 수 있는 이퀄라이저 기능 탑재

- * Standard Chassis Jack for Connecting a Flex Cable
- * A Separate Audio Input Enables Connection with DECT, Mobile or Two way Radio Equipment
- * Last setting is Stored when Switched Off
- * Automatic Shut-off after Two Hours if No Function is Used
- * Warning Signal When Power is Low, Before Shut-off
- * Audio Input Jack for External Radio
- * PTT Button on Ear Shell

<B4>

Ea.	Price,₩
	616,000
	700,000
	616,000

- 3M.03.5165** (1) Headset, Head Band type, 25dB
3M.03.5166 (2) , Neck Band type, 24dB
3M.03.5167 (3) , Helmet Detached type, 22dB

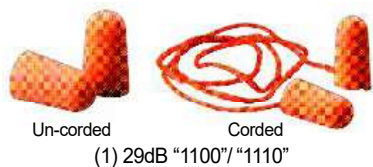

Un-corded Corded
(1) 29dB "1100"/"1110"

3M® Comfort Wide-range Ear Plug, 29~33dB/NRR
Made of PU and PVC Foam, ANSI-compliance, **다양하고 편안한 귀마개**

- **Wide-range and Variable-types : 29~33dB/NRR(Noise Reduction Rate)-Compliance ANSI**
- **Smooth, Soft Materials : Polyurethane (PU) Foam and PVC Foam : Non-allergenic, Non-irritating and Dermatologically Safe to Skin.**
- **Easy Use : Simply Compress the Soft Plug, Insert in Ear Canal, and let the Plug Expand**

(1) "1100/1110" 29dB Basic-type, PU-Foam

- * Woven Connecting Cord ("1100") : Less Risk of Loss
- * Anti-allergic & Soft Material. * Anti-pollution Surface.

<B4>

- 3M.03.5045** "1100" Un-corded Ear plug, PU, 29dB
3M.03.5046 "1110" Corded Ear plug, PU, 29dB

Pk.	Price, ₩	Cs.	Price, ₩
1pair	220	200pair	
1pair	490	200pair	

(2) "Classic" 29dB Cylindrical-type, PVC-Foam

- * Waterproof Material : Minimize Sweat Absorption & Long-lasting Resilience.
- * Minimize Skin Stimulation. * High Protection & Comfortable

- 3M.03.5047** "Classic" Ear plug, PVC, 29dB, Un-corded
3M.03.5048 , Corded

Pk.	Price, ₩	Cs.	Price, ₩
1pair	170	200pair	
1pair	410	200pair	

(3) "TaperFit" 32dB 2Foam-type, PU-Foam

- * Minimize Skin Stimulation.
- * Soft & Low Pressure Material * Wearable, Comfortable.

- 3M.03.5049** "TaperFit" Ear plug, PU, 32dB, Un-corded
3M.03.5050 , Corded

Pk.	Price, ₩	Cs.	Price, ₩
1pair	140	200pair	
1pair	320	200pair	

(4) "EarSoft" 33dB Ultra-soft type, Neon-Yellow, PU-Foam

- * High Sound Insulation Degree.
- * Soft & Low Pressure Material * Wearable, Comfortable.

- 3M.03.5051** "EarSoft" Ear plug, PU, 33dB, Un-corded
3M.03.5052 , Corded

Pk.	Price, ₩	Cs.	Price, ₩
1pair	220	200pair	
1pair	450	200pair	

1000 Pcs./Clean Bottle Pack and One Touch Dispenser

* Earplugs can be used conveniently and hygienically

- 3M.03.5168** (5) "1100" 1000 Pcs/Bottle Pack, Un-corded **New**
3M.03.5169 (6) "1100" 1000 Pcs/Bulk-type, Un-corded **New**
3M.03.5053 (7) "EarSoft" 1000 Pcs/Bottle Pack, Un-corded
3M.03.5116 (8) One Touch Dispenser only

Pk.	Price, ₩
500pair	105,000
500pair	98,000
500pair	88,200
1ea	119,000



Un-corded Corded
(2) 29dB "Classic"

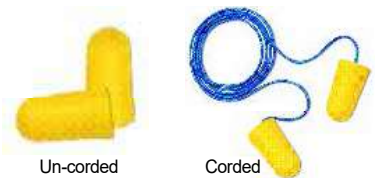

Un-corded Corded
(3) 32dB "TaperFit"

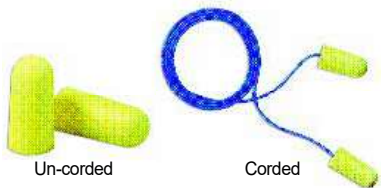

Un-corded Corded
(4) 33dB "EarSoft"



(5), (7)
Bottle Pack

(8) One Touch Dispenser

Articles	Cat. No	Description
----------	---------	-------------

Otos® Safety PC Comfort Face-shield, High Impact Polycarbonate, with or without Headgear(Band) **NEW**

Ideal for Protection of Chemical Splash · Heat · Impact · Welding · 99.9% UV, 편리한 PC 보안면

※ **Note! SP Shade Lens**
견본색상 (#3~#7)

Shade #3



Shade #4



Shade #5



Shade #7



▶ 견본색상은 KS, 노동부 규격의 차광번호의 농도입니다.

▶ 인쇄로 인해 실제 제품과 색상이 다소 차이가 있을 수 있습니다.

I. With Headgear(Band), 맨머리형



- 맨머리형
- 헤드밴드의 높이, 둘레 크기 조절
- 유리섬유가 함유된 나일론소재 사용으로 열에 대한 방어효과가 우수 <B3>

ORDER NO.	MODEL NO.	PRICE, ₩ Ea.	차광도	중량(g)	포장단위 Ea. / Cs.
▶ 0236-121	F-65A	10,540	투명	272	1 / 16
▶ 0236-123	F-65B	12,570	#3~#7	272	

II. With 3D Curve Lens & Headgear(Band), 맨머리형



- 3차원 곡면 렌즈
- 맨머리형
- 헤드밴드의 높이, 둘레의 크기 조절
- 넓은 시야와 보호 면적 강화

ORDER NO.	MODEL NO.	PRICE, ₩ Ea.	차광도	중량(g)	포장단위 Ea. / Cs.
▶ 0350-616	F-72A	9,770	투명	315	1 / 16
▶ 0350-617	F-72B	14,020	#3~#7	315	1 / 12

III. Without Headgear, 헬멧 부착형

(1) 모든 헬멧에 탈부착 가능형, 내열성 우수



(1) 모든 헬멧에 탈부착 가능형, 내열성

ORDER NO.	MODEL NO.	PRICE, ₩ Ea.	차광도	중량(g)	포장단위 Ea. / Cs.
▶ 0236-115	F-63A	7,690	투명	246	1 / 50
▶ 0342-805	F-63B	9,860	#3~#7	246	1 / 50

(2) 부착홈이 있는 헬멧에만 부착형



(2) 부착홈이 있는 헬멧에만 부착 가능형

ORDER NO.	MODEL NO.	PRICE, ₩ Ea.	차광도	중량(g)	포장단위 Ea. / Cs.
▶ 0236-116	F-64A	7,690	투명	211	1 / 40
▶ 0449-794	F-64B	9,860	#3~#7	211	1 / 50



3M® Speedglas™ 100 Welding Helmet, with 100V Filter, for Various Welding, Comfortable to Wear Excellent Optical Quality, Reliable Light-to-Dark Switching, Ease to Use, 자동용접면 **NEW**

- 작업성을 고려한 세련된 디자인으로 생산성 향상
- 뛰어난 광학기술 적용하여 용접품질 향상
- 5단계 차광도 조절기능으로 다양한 용접 가능
- 4단계 민감도 조절기능과 용접직후 눈보호를 위한 Delay 조절기능탑재
- 신형 헤드밴드 적용하여 편안한 착용감

- * 5 Adjustable Dark Shades 8-12 & Light Shade of 3
- * Sensitivity Adjustment that Allows Use with all Stick, MIG and TIG Welding Processes
- * 3 Selectable Sensitivity Levels for Reliable Arc Detection
- * Optical Quality Gives Worker a Good View of the Work Area
- * 100V Auto Darkening Filter : Selectable Dark Shades 8 through 12 and Viewing Area
- * 4 Sensitivity Settings
- * Possible to Automatical Delay
- * High Impact Rating According to the Requirements of the European Standard EN 175:B
- * Compatible with most 3M® Filtering Facepiece Respirators

<B4>

3M.03.100 Welding Helmet, 100, Lithium Battery(CR 2032), Black

Ea.	Price, ₩
	224,000

Articles

Cat. No

Description



DF 분말 소화기 KOREA

Fire Extinguisher, Dry Chemical

- 뛰어난 소화력으로 범용(ABC)으로 널리 사용
- 압력계 부착으로 육안으로 사용가능 여부 판단
- 축압된 용기에 약제는 외부 습기에 응고되지 않음

<B3>

	Ea.	Price, ₩
0514-170 분말소화기, 1.5kg(차량 겸용)		22,060
0514-175 , 3.3kg		25,480
0514-173 , 4.5kg		45,780

▲ 3.3 kg



DF 345ml 미니 Spray 소화기 세트 KOREA

Aerosol Type Fire Extinguisher

- 구성품 : 미니소방관+거치대
- Spray분사형, 쉬운 사용법
- 소형 휴대용 타입

<B3>

	Ea.	Price, ₩
0514-265 미니소화기세트, 345ml		13,530



▲ 받침대형 (3.3kg 용)

DF 소화기 받침대 KOREA

Extinguisher Stand

<B3>

	Ea.	Price, ₩
0514-873 소화기 stand, 1.5kg용		2,840
0514-874 , 3.3kg용		2,840



DF 소화기 표지판 KOREA

Extinguisher Guide

- 축광 아크릴타입

<B3>

	Ea.	Price, ₩
0514-882 소화기표지판		3,860

Articles	Cat. No	Description
----------	---------	-------------

3M® Chemical Splash / Impact Safety Goggle & OTG Spectacle, Fit Well Over Glasses/Eyewear, Coated Clear PC Lens With Ventilation System(except OTG Spectacle), Anti-Fog · Scratch · UV 99.9%, 안경위에 겹쳐쓸수있는 다용도 보안경

- **Coated Clear Polycarbonate Flexible Lens : Resist Fogging / Impact / Scratching / 99.9% UV.**
- **Large & Soft PVC Frames with Indirect Ventilation System**
- **Adjustable Headstrap for a Custom Fit.**
- * Integrated Undirect Ventilation System(except OTG Spectacle)
- * OTG-type ; One-Piece Molded Polycarbonate Lens / Frame / Side shield : Wide View Wraparound Spectacle, DX®-Coated : Anti-Fog / Hard Coating, and Adjustable Temple Length.
- **Fit Well Over Glasses or Most Eyewear**
- **Also, Provide ideal Protection from Particulates.**
- * Meets CSA Z94.3 and ANSI Z87.1 Standards

																			
(1) "334AF" Traditional	(2) "332AF" Standard	(3) "454AF" Premium	(4) "40654" Low-profile																
<ul style="list-style-type: none"> * Indirect Vented * "40661" Chemical Splash Safety * 74g 	<ul style="list-style-type: none"> * Direct Vent * Impact Resist * "332AF" Chemical Splash Safety * 74g 	<ul style="list-style-type: none"> * Wide View, Comfort. * Indirect Vented * "40305" Chemical Splash Safety * 94g 	<ul style="list-style-type: none"> * Fit Well ; Helmets & Respirations. * Indirect Vented * "40654" Chemical Splash Safety * 110g 																
<table border="1" style="font-size: small;"> <tr><th colspan="2">Pk. Price, ₩</th></tr> <tr><td>3M.03.5014</td><td>"334AF" 1ea 2,520</td></tr> </table>	Pk. Price, ₩		3M.03.5014	"334AF" 1ea 2,520	<table border="1" style="font-size: small;"> <tr><th colspan="2">Pk. Price, ₩</th></tr> <tr><td>3M.03.5173</td><td>"332AF" 1ea 2,740</td></tr> </table>	Pk. Price, ₩		3M.03.5173	"332AF" 1ea 2,740	<table border="1" style="font-size: small;"> <tr><th colspan="2">Pk. Price, ₩</th></tr> <tr><td>3M.03.5015</td><td>"454AF" 1ea 11,200</td></tr> </table>	Pk. Price, ₩		3M.03.5015	"454AF" 1ea 11,200	<table border="1" style="font-size: small;"> <tr><th colspan="2">Pk. Price, ₩</th></tr> <tr><td>3M.03.5016</td><td>"40654" 1ea 15,830</td></tr> </table>	Pk. Price, ₩		3M.03.5016	"40654" 1ea 15,830
Pk. Price, ₩																			
3M.03.5014	"334AF" 1ea 2,520																		
Pk. Price, ₩																			
3M.03.5173	"332AF" 1ea 2,740																		
Pk. Price, ₩																			
3M.03.5015	"454AF" 1ea 11,200																		
Pk. Price, ₩																			
3M.03.5016	"40654" 1ea 15,830																		

																			
(5) "40654 Plus A" High-profile	(6) OTG Standard-Grip Spectacle	(7) OTG Secure-Grip® Spectacle	(8) "SF-3701-AS"																
<ul style="list-style-type: none"> * Anti-fog Coated Lens * Wide View, Comfort * "40654 Plus" Chemical Splash Safety * Indirect Vented 	<ul style="list-style-type: none"> * Adjustable Temple Length. * "12163" DX® Hard Coat * 46g 	<ul style="list-style-type: none"> * Stable Temple-Adjustable Length. * "12166" DX® Hard Coat. * 47g 	<ul style="list-style-type: none"> * Comfortable fit * Adjustable Temple Length * 47g 																
<table border="1" style="font-size: small;"> <tr><th colspan="2">Pk. Price, ₩</th></tr> <tr><td>3M.03.5171</td><td>"40654 Plus A" 1ea 17,510</td></tr> </table>	Pk. Price, ₩		3M.03.5171	"40654 Plus A" 1ea 17,510	<table border="1" style="font-size: small;"> <tr><th colspan="2">Pk. Price, ₩</th></tr> <tr><td>3M.03.5017</td><td>"OX1000" 1ea 4,600</td></tr> </table>	Pk. Price, ₩		3M.03.5017	"OX1000" 1ea 4,600	<table border="1" style="font-size: small;"> <tr><th colspan="2">Pk. Price, ₩</th></tr> <tr><td>3M.03.5018</td><td>"OX2000" 1ea 5,880</td></tr> </table>	Pk. Price, ₩		3M.03.5018	"OX2000" 1ea 5,880	<table border="1" style="font-size: small;"> <tr><th colspan="2">Pk. Price, ₩</th></tr> <tr><td>3M.03.5172</td><td>"SF3701AS" 1ea 9,390</td></tr> </table>	Pk. Price, ₩		3M.03.5172	"SF3701AS" 1ea 9,390
Pk. Price, ₩																			
3M.03.5171	"40654 Plus A" 1ea 17,510																		
Pk. Price, ₩																			
3M.03.5017	"OX1000" 1ea 4,600																		
Pk. Price, ₩																			
3M.03.5018	"OX2000" 1ea 5,880																		
Pk. Price, ₩																			
3M.03.5172	"SF3701AS" 1ea 9,390																		

3M® Secure FIT™ Side Shield-style Safety Spectacle, Coated Color One-piece Molded PC Lens, Comfortable Fit Ideal for Wraparound Protection, Ideal for Wraparound Protection, 측면이 보강된 보안경

		<ul style="list-style-type: none"> ■ PDT 압력 분산 기술로 편안하게 착용 가능, 대부분 안경 위에 착용 가능 ■ Meets the Requirements of EN 166:2001 ■ Fit Well Over Glasses or Most Eyewear * Versatile Design Allow Use with Wide Variety of Prescription Eyewear * PDT(Pressure Diffusion Temple) Technology : Helps Diffuse Pressure over the Ear for a Secure * Adjustable Ratchet Temples Allow User to Adjust Lens for Facial Features and Eyeglass Position * Provide Additional Coverage from Particulates * (5)-Forehead Protection, Adjust-Temples Spatula Length & Nose Bridge 														
(1)	(2)															
																
(3)	(4)															
	(5)															
<table border="1" style="font-size: small; width: 100%;"> <tr> <th style="width: 15%;">3M.SF3703SGAF</th> <th style="width: 70%;">(1) Spectacle, Side Shield-type, 47g, Amber New</th> <th style="width: 15%;">1ea 15,400</th> </tr> <tr> <td>3M.SF3717AS</td> <td>(2) , I/O Grey New</td> <td>1ea 15,400</td> </tr> <tr> <td>3M.SF3730AS</td> <td>(3) , IR3.0 New</td> <td>1ea 15,400</td> </tr> <tr> <td>3M.SF3750AS</td> <td>(4) , IR5.0 New</td> <td>1ea 15,400</td> </tr> <tr> <td>3M.03.5020</td> <td>(5) , 31.2g, Clear</td> <td>1ea 8,830</td> </tr> </table>		3M.SF3703SGAF	(1) Spectacle, Side Shield-type, 47g, Amber New	1ea 15,400	3M.SF3717AS	(2) , I/O Grey New	1ea 15,400	3M.SF3730AS	(3) , IR3.0 New	1ea 15,400	3M.SF3750AS	(4) , IR5.0 New	1ea 15,400	3M.03.5020	(5) , 31.2g, Clear	1ea 8,830
3M.SF3703SGAF	(1) Spectacle, Side Shield-type, 47g, Amber New	1ea 15,400														
3M.SF3717AS	(2) , I/O Grey New	1ea 15,400														
3M.SF3730AS	(3) , IR3.0 New	1ea 15,400														
3M.SF3750AS	(4) , IR5.0 New	1ea 15,400														
3M.03.5020	(5) , 31.2g, Clear	1ea 8,830														

3M® Secure FIT™ Super Light-weight Safety Spectacle, PC Lens Coated, Comfortable Fit, 19g NEW

Ideal for Wraparound Protection, Anti-Fog · Scratch · UVA & UVB 99.9%, 초경량 보안경

- PDT 압력 분산 기술로 편안하게 착용 가능, 초경량(19g)
- Meets the Requirements of CSA Z94.3 or the High Impact Requirements of ANSI Z87.1
- * PDT(Pressure Diffusion Temple) Technology : Helps Diffuse Pressure over the Ear for a Secure
- * Provide Additional Coverage from Particles
- * Soft Nosepiece Helps Reduce Slippage



Secure Fit 400 Series

- * Scotchgard™ Anti-Fog/Scratch Coating Resists Fogging Longer than Traditional Coatings, Even after Multiple Washes
- * Super Light-weight 19g * Soft Nose Bridge

- 3M.SF401AF** (1) Spectacle, Light-weight, 19g, Clear
- 3M.SF402AF** (2) , Grey

<B4>	
Pk. Price, ₩	
1ea	5,190
1ea	5,750

Secure Fit 300 Series

- * Anti-fog * Comfortable Fit

- 3M.SF301SGAF** (3) Spectacle, 19g, Clear
- 3M.SF302SGAF** (4) , Grey

Pk. Price, ₩	
1ea	5,880
1ea	6,160

3M® Light-weight Multi-use Safety Spectacle, Safety Coated PC Lens, Comfortable Fit NEW

Ideal for In- & Out-door Act, Anti-Fog · UV 99.9%, 경량 보안경, 실내 & 야외 겸용



- 마스크 착용으로 인한 김서림 및 과격한 작업으로 땀에 의해 발생하는 김서림 방지에 탁월함
- 실내와 야외 겸용으로 사용가능, 충격에 강한 소재로 각종활동에서 안전하게 사용가능
- Meets the Requirements of EN 166:2001
- Coated Polycarbonate Lens : Scotchgard™ Anti-Fog Coated / UVA&UVB 99.9%
- * Provide Complete Impact Protection * Adjustable for Nose Bridge
- * Integrated Side-shield Provides Additional Protection for Surrounding Tissues

- 3M.AP300SG** (1) Spectacle, Light-weight, 28g, Clear
- 3M.AP301SG** (2) , Yellow
- 3M.AP305SG** (3) , Orange
- 3M.AP302SG** (4) , Dark-grey

Pk. Price, ₩	
1ea	19,600
1ea	19,600
1ea	19,600
1ea	19,600

Articles	Cat. No	Description										
 Front (1) Chest Harness	 Back	 Front (2) Full Body Harness	 Back Dongmyung® Chest or Full Body Harness, Antistatic, Washable, One Touch Buckle With Webbing Rope · Waist & Shoulder Pad, Suitable for Industrial, KCS Certified, 안전벨트 NEW ■ Made in Korea ■ KCS Certified ■ 정전기 방지 ■ 어깨 및 허리에 보호대가 있어 충격 완화가 되며 착용감이 좋음 * Made of Polyester High Tenacity Yarn * Buckle : Steel, One Touch * Contraction, Scratch, Loosening Prevention * Shock absorbing lanyard <B4> (1) Chest Harness, Steel Buckle, Aluminum Hook DH.Har2001 Harness, Chest, Steel Buckle, Aluminum Hook (2) Full Body Harness, Steel Buckle, Steel Hook DH.Har2003 Harness, Full Body, Steel Buckle, Steel Hook	<table border="1"> <thead> <tr> <th>Ea.</th> <th>Price, ₩</th> </tr> </thead> <tbody> <tr> <td></td> <td>29,400</td> </tr> </tbody> </table> <table border="1"> <thead> <tr> <th>Ea.</th> <th>Price, ₩</th> </tr> </thead> <tbody> <tr> <td></td> <td>33,600</td> </tr> </tbody> </table>	Ea.	Price, ₩		29,400	Ea.	Price, ₩		33,600
Ea.	Price, ₩											
	29,400											
Ea.	Price, ₩											
	33,600											

, Helmets 안전모

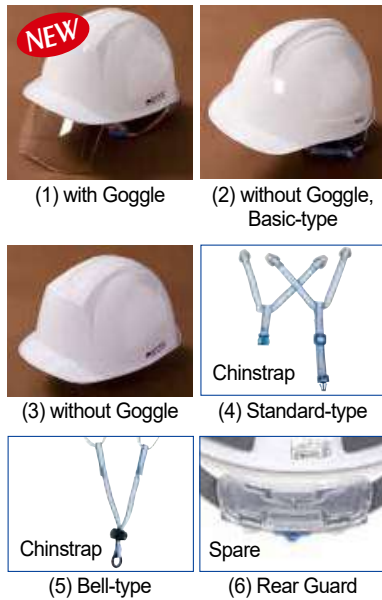

Dongmyung® Safety ABS Helmet, Screw-type Considering Head Size, with or without Goggle Suitable for Industrial, Adjustable Length Chinstrap, 안전모 NEW

- Made in Korea
- * 인체공학적 설계를 통해 심미감, 착용감, 안전성 강화, 내외 충격 완화
- * 강화된 내장재 장착을 통해 내충격 방지 및 통증, 압박감 완화를 통해 착용감 향상
- * 보안경 : UV 코팅 적용으로 김서림 및 스크래치 방지, 작업자의 안면부 보호(탈부착 가능), 이물질 제거, 시야 확보, 안정성 강화.
- * Ergonomic Design : Aesthetic, Comfort, Safety Enhancement, Relieve the Shock of Inside and Outside <B4>
- * UV Coated Polycarbonate goggle : Resist Fogging / Impact / Scratching

- DH.Hel3001** (1) Safety Helmet, with Goggle, ABS
- DH.Hel3002** (2) , without Goggle, ABS, Basic-type
- DH.Hel3005** (3) , without Goggle, ABS

Ea.	Price, ₩
	4,200
	5,600
	12,600

Spare Accessories

- DH.Hel3011** (4) Chinstrap, for Safety Helmet, Standard-type
- DH.Hel3012** (5) , Bell-type
- DH.Hel3013** (6) Rear Protection Guard, for Safety Helmet

Ea.	Price, ₩
	1,400
	1,400
	2,110

KF94 Fine Dust & Epidemic Prevention Mask, 2D & 3D with KFDA Approval, PM2.5 Protection Filter NEW

Ideal for Respiratory Protection from Fine Dust and Virus, KF94 황사차단·방역 마스크



- Made in Korea
- 식품의약품 안전처 허가 상품
- 아릴아민 & 폼알데하이드 테스트 통과 완료
- * KF : Filter Grade Approved by KFDA
- * KF94 : 0.4 μ m Fine Dust Protection 94%.
- * KFDA(Korean Ministry of Food and Drug Safety) Approved
- * PM2.5 : 2.5 μ m Fine Dust Protection
- * Prevent Infectious Disease Respiratory Infections
- * 3D Structure for Easy Breathing with Soft Earband
- * Suitable for Various Face Shapes
- * Non-stick to Face
- * Helps reduce exposure to Yellow Dust, ragweed and Harmful Substance.

DH.Mas3001	(1) Fine Dust Mask, KF94, 3D, 210×77(Max154)mm, White
DH.Mas3002	(2) , 2D, 150×130mm, White
DH.Mas3007	(3) , Black

Pk.	Price, ₩	Cs.	Price, ₩
1ea	360	100pk	
1ea	420	100pk	
1ea	420	100pk	

KF94 Fine Dust & Epidemic Prevention Mask, for Infants & Children, with KFDA Approval, with Meltblown Fabric Filtration, 4-Layer Filtering NEW

Ideal for Respiratory Protection from Fine Dust and Virus, 아동용 KF94 황사차단·방역 마스크



- Made in Korea
- 식품의약품 안전처 허가 상품
- 아릴아민 & 폼알데하이드 테스트 통과 완료
- Ideal for Kids with Weakened Immune Systems and Requiring to Prevent Infectious Disease Respiratory Infections
- * KF : Filter Grade Approved by KFDA
- * KF94 : 0.4 μ m Fine Dust Protection 94%.
- * KFDA(Korean Ministry of Food and Drug Safety) Approved
- * Prevent Infectious Disease Respiratory Infections
- * Provide Higher Levels of Resistance to Airborne Liquids
- * Non-stick to Face
- * Structure for Easy Breathing with Soft Earband
- * Thanks to Meltblown Fabric Filtration & 4-Layers Protection, Safe and Comfortable to Use
- * Helps reduce exposure to Yellow Dust, ragweed and Harmful Substance.

DH.Mas3005	Mask, KF94, for Infants, 158×57(Max116)mm, White
DH.Mas3006	, for Children, 182×67(Max135)mm, White

Pk.	Price, ₩	Cs.	Price, ₩
1ea	410	100pk	
1ea	410	100pk	

AD(Anti-Droplet) Mask with or without KFAD Approval, with Meltblown Fabric Filtration, 3-Layer Filtering, BFE 95~99% NEW

Ideal for Airborne Liquids Protection, Excellent Face Adhesion & Durable Ear Straps, 일회용 마스크



- Provide Higher Levels of Resistance to Airborne Liquids
- Prevent Infectious Disease Respiratory Infections
- Ideal for any Situation Requiring Safe Guard and Healthy Breathing such as Daily life, Laboratory, Require Cleanliness and Hygienic work, Outdoor Activity
- * With Meltblown Fabric Filtration & 3-Layers Protection, Safe and Comfortable to Use
- * Shape Memory Wire : Maintaining the Shape of the Nose, Prevention of Misting
- * With Durable & Comfortable Ear Straps
- * Light Weight & Comfortable Breathing Compared to KF 80/KF 94

(1) KF-AD(Anti-Droplet) Protective Mask, Medical Use, KF-AD 비밀 차단 마스크

- Made in Korea
- 식품의약품 안전처 허가 상품
- 아릴아민 & 폼알데하이드 테스트 통과 완료
- KF-AD(Korea Filter Anti-Droplet)
- * KF : Grade Approved by KFDA
- * KFDA(Korean Ministry of Food and Drug Safety) Approved
- * BFE 95% : Fine Dust Protection 90% / 3 μ m Bacterial Filtration Efficiency(BFE) 95%

DH.Mas3003	Anti-Droplet(KF-AD) Mask, Disposable, 175×95mm, White
-------------------	---

Pk.	Price, ₩	Cs.	Price, ₩
50ea	5,830	40pk	

(2) & (3) SciLab® Protective AD(Anti-Droplet) Mask, White & Blue, 일회용 3중 필터 마스크, BFE 99%

- KATRI (한국의류시험연구원) 아릴아민 & 폼알데하이드 테스트 통과 완료
- 3 μ m크기의 박테리아 차단기능 99%
- 위생적이고 편리한 속 포장(10pcs./Pk.)
- KATRI (Korea Apparel Testing and Research Institute) Arylamine & Formaldehyde Test Passed
- CE Certified
- According to ASTM F2101
- BFE 99%: 3 μ m Bacterial Filtration Efficiency(BFE) 99%
- * Very Hygienic and Convenient Package : 10pcs./Inner Pack, 50pcs.(=5 Inner Packs)/Pack



Certificate by KATRI 10pcs. / Inner Vinyl Pack

SL.Mas3011	(2) AD(Anti-Droplet) Mask, 175×95mm, White
SL.Mas3012	(3) , Blue

Pk.	Price, ₩	Cs.	Price, ₩
50ea	9,380	40pk	
50ea	9,380	40pk	

Articles	Cat. No	Description
----------	---------	-------------

3M® Maintenance-Free Particulate Respirator, Light Weight, Comfortable & Convenient, Variety of Strap Attachments and Types With Cool Flow® Exhalation Valve, Soft Inner Materials, 방진 마스크 특급 · 1급 · 2급

Superior Respirator



- Compatible with most Eye and Hearing Protection
- Cool Flow® Exhalation Valve : Proprietary One-way Valve for Easy Exhalation and Cool Comfort.
- Proprietary Noseclip Adjusts Easily for Fewer Pressure Points and Greater Comfort

3M® Superior Respirators, High Efficiency HEPA Filter, 100 Class Cool Flow® Exhalation Valve

* Ideal for Specific Contaminants Including Lead, MDA, Arsenic, Cadmium, Additionally for Welding, Pharmaceutical Manufacturing.
 * Application : Metal Smelting, Laboratories, Power Plants and Other High-risk Workplace Dust Generation <B4>
 * HEPA(High Efficiency Particulate Air) Filter, with Cool Flow® Exhalation Valve

		Pk.	Price, ₩
3M.03.5078	(1) Respirator, 100 Class, 9332K+, Hazardous Dust and Radioactive Particles	10ea	39,200
3M.03.5079	(2) Respirator, 100 Class, 8233, Head Strap of Soft Material, Comfortable to Wear Nose Form, Good for Workplace of High Risk Dust Generation, Asbestos Handling, Alloy Molding, Processing	1ea	12,750

High Protective Respirator



3M® High Protective Respirators, Dust · Mist · Welding Fume · Special Adsorption Layer Added

* Proprietary Filter Media with Electrostatically Charged Microfibers help make Breathing Easier and Cooler.
 * Cool Flow® Exhalation Valve * Dust / Mist / Welding Fume
 * Application : Cause Metal Fume Area, Welding, Soldering, Metal Casting, Casting, Forging, Smelting Steel, Metal Processing Workplace of High Risk Dust Generation Laboratory, Construction, Pharmaceutical Inspection and Repair of Equipment

		Pk.	Price, ₩
3M.03.5181	(3) Respirator, High Protective, 8955K, 3D Nose Foam, Faceseal, with Hook New	10ea	17,790
3M.03.5080	(4) Respirator, High Protective, 8822, for Welding & Soldering Fume	10ea	16,800
3M.03.5182	(5) Respirator, High Protective, 8922, Faceseal, Comfortable to wear with Ring New	10ea	20,720
3M.03.5081	(6) Respirator, High Protective, 9322K+, Flat Fold, Head Strap of Soft Material, Comfortable to Wear Nose Form	10ea	22,400
3M.03.5082	(7) Respirator, High Protective, 8511, HEPA Filter, M Clip, Wide Seal	10ea	21,000



* with Special Adsorption Layer(Dust / Mist / Welding Fume / Nuisance Odor)
 * with Nuisance Odor, With Special Adsorption Layer. * Note! : Can not be Used as a Gas Mask
 * Installed Cool Flow® Exhalation Valve

		Pk.	Price, ₩
3M.03.5083	(8) Respirator, High Protective, 9913V, Organic Solvent Smell	10ea	32,200
3M.03.5084	(9) Respirator, High Protective, 8514, with HEPA Filter with Adsorption layer : Remove Odor of Ozone / Organic Solvents	10ea	86,800
3M.03.5085	(10) Respirator, High Protective, 8576, with HEPA Filter, M-Clip, Wide Seal Mercury, Chlorine, Acid-based Smell / Remove Odor Adsorbing Layer Added, Metal Fume Generation Workshop	10ea	57,400

Standard Protective Respirator

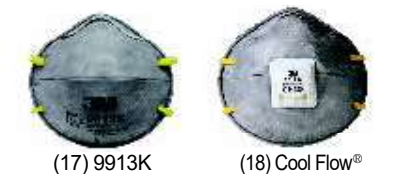
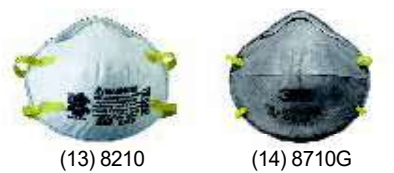

3M® Standard Protective Respirators, Dust · Mist · Special Adsorption Layer Added

* Comfortable, Reliable Worker Respiratory Protection against Certain non-Oil Based Particles.
 * 3-layered HEPA Filter * Dust / Mist
 * Ideal for Construction, Chemistry / All Manufacturing : Grinding, Cutting, Machining, Molding, Material Handling, Inspection Repair of Equipment, Plastic and Rubber Molding, Processing, Pesticides, Dyes / Other Various Dust Work

		Pk.	Price, ₩
3M.03.5086A	(11) Respirator, Standard Protective, 8605, Elastic Headband	10ea	5,750
3M.03.5087	(12) Respirator, Standard Protective, 8710L, Superior Comfort / Durability Headband	20ea	14,000
3M.03.5088	(13) Respirator, Standard Protective, 8210, Prevent Clogging Structure of the Surface, Adjustable Natural Rubber Head Strap	20ea	20,160
3M.03.5089	(14) Respirator, Standard Protective, 8710G, Gray Outside, Not Well Stained by Debris	20ea	16,240
3M.03.5090	(15) Respirator, Standard Protective, 8812K, Installed Cool Flow® Exhalation Valve	10ea	11,200
3M.03.5092	(16) Respirator, Standard Protective, 9310K+, Flat Fold Style, Soft Material Head Strap, Wearable Nose Form, Lightweight Design (10g)	20ea	23,800

* with Special Adsorption Layer(Dust / Mist / Welding Fume / Nuisance Odor)
 * with Nuisance Odor, With Special Adsorption Layer. * Note! : Can not be Used as a Gas Mask
 * Application : Handling Areas Dyes / Pigments, Petrochemicals, Printing Cigarette Manufacturing, the Smell of Pesticides / Organic-based, Odor Generation Workshops

		Pk.	Price, ₩
3M.03.5093	(17) Respirator, Standard Protective, 9913K	20ea	44,800
3M.03.5094A	(18) , 9914, Cool Flow® Valve	10ea	27,310
3M.03.5095	(19) Respirator, Standard Protective, 8246, Mercury, Added Acid-based Absorption Layer, Aluminum, Glass Etching, Chemical Process the Hydrogen Fluoride, Vhlorine, Acid Based Odor Generation Workshop	20ea	58,800

3M® “3200” & “HF-50” Single Cartridge Half Facepiece Respirator, For Reliable & Convenient Respiratory Protection
Can be Used Only with 3000 & 1700 Series Filters & Cartridges, Lightweight, Reusable, 단구형 방독 호흡보호구



(1) 3200

(2) HF-50

- Low Profile Design Allows a Wide Field of Vision
 - Soft, Elastomeric Face-fit Secures a Lasting Comfort
 - Suggested Applications : Welding, Painting, Grinding, Abatement Activities, Chemical Handling and Mixing, and other Applications where Gas or Particulate Protection is required
- * Can be Used Cartridges or Filters by Purpose of Use

(1) “3M” Single Cartridge Half Facepiece Respirator, 3200, Soft TEP Material

<B4>

* Unique Easy to On / Off Strap System

Ea.	Price, ₩
-----	----------

3M.03.5105 Respirator, Half Facepiece, Single Cartridge, 3200, Medium

	10,920
--	--------

(2) “3M” Single Cartridge Half Facepiece Respirator, HF-50, Silicone Material NEW

* Cool Flow® Valve : Easy Breathing, Reducing Heat and Moisture Build-up for Cool, Dry Comfort.

Ea.	Price, ₩
-----	----------

3M.03.5211 Respirator, Half Facepiece, Single Cartridge, HF-50

	16,110
--	--------

3M® “7771” & “7772” Single Cartridge Half Facepiece Respirator & Filter, For Reliable & Convenient Respiratory Protection NEW
Used with 7744 Series Filters, Lightweight, Silicone, Reusable, 단구형 방독 호흡보호구 및 방진 필터



(1) “3M” Single Cartridge Half Facepiece Respirator, “7771” & “7772”, Silicone

- 내구성이 뛰어나고, 내충격성 및 내화학성이 좋은 특수 플라스틱 사용
- 용접면 등과의 간섭을 최소화 하고 원활한 시야 확보가 가능한 디자인
- 사용 가능 작업장 : 페인팅 자동차 제조, 화학공장, 제약, 석유화학, 1차 금속 가공업등

* Cool Flow™ Valve : Easy Breathing, Reducing Heat and Moisture Build-up for Cool, Dry Comfort

* Allows for Wider Field of View the Respirator

<B4>

Ea.	Price, ₩
-----	----------

3M.03.7771 Respirator, Single Facepiece, Single Cartridge, Medium

	20,310
--	--------

3M.03.7772 , Large

	20,310
--	--------

(2) Particular Filter, for Respirator “7771” & “7772”

* 낮은 호흡저항과 높은 필터 효율 제공

* 분진/미스트/흙/냄새 제거용 활성탄 첨가

* 용도: 용접, 납땀, 그속주물, 주조, 단조 등 흙 분진

* 7744C: 냄새 제거용 활성탄 첨가로 냄새 발생작업장에 적합, 7744: 미스트 발생작업장에 적합

Ea.	Price, ₩
-----	----------

3M.03.7744 ① Optional, Filter

	1,400
--	-------

3M.03.7744C ② , Filter with Activated Carbon

	1,550
--	-------



(2)-① No.7744

(2)-② No.7744C

Articles	Cat. No	Description
----------	---------	-------------

3M® Half Facepiece Respirator, Reusable, Can be Used with Filters & Cartridges, Direct Connection Cartridge For Reliable & Convenient Respiratory Protection, Advanced Silicone Material, 호흡보호구



(1) Premium Half Facepiece Respirator, 7500 Series, Cool Flow® Exhalation Valve

- Easy Breathing, Comfortable and Durable Respiratory Protection.
- Advanced Silicone Material for Increased Comfort and Greater Durability
- Dual Airline Systems against a Variety of Gases, Vapors and Particulate Hazards.
- Suggested Applications : Abatement, Painting, Welding, Chemical handling, Battery manufacturing, Construction, Utilities, Mining, Pharmaceutical, Smelting

- * Reliable, Convenient Respiratory Protection when Combined with "3M" Particulate Filters or Cartridges.
- * Remarkably Comfortable, Soft, Lightweight Facepiece and Easy-to-Adjust Head Straps.
- * Reusable - Just Dispose of the Cartridges/Filters when Used to Capacity
- * Comes with Reclosable Storage Bag * Can be Used Cartridges or Filters by Purpose of Use.
- * NIOSH approved for negative pressure air purifying and positive pressure dual airline applications
- * Cool Flow® Valve : Easy Breathing, Reducing Heat and Moisture Build-up for Cool, Dry Comfort.

NEW



(2) Half Facepiece Respirator, 6500 Series Cool Flow™, Rugged Comfort

(1) "3M" Premium Half Facepiece Respirator, 7500 Series, Cool Flow® Exhalation Valve

<B4>

- * Unique Adjustment Design helps Reduce Pressure Points on the Face for Unsurpassed Comfort.

	Ea.	Price, ₩
3M.03.5191 Respirator, Half Facepiece, Premium, 7501, Small, w/o Filter & Cartridges New		36,400
3M.03.5060 , 7502, Medium, w/o Filter & Cartridges		36,400
3M.03.5192 , 7503, Large, w/o Filter & Cartridges New		36,400

(2) "3M" Half Facepiece Respirator, 6500 Series, Cool Flow®, Rugged Comfort

NEW

- * Quick Latch Design Offers One-hand Touch Drop-Down for Putting the Facepiece on and Taking it off

	Ea.	Price, ₩
3M.03.5193 Respirator, Half Facepiece, 6501, Small, w/o Filter & Cartridges		22,400
3M.03.5194 , 6502, Medium, w/o Filter & Cartridges		22,400
3M.03.5195 , 6503, Large, w/o Filter & Cartridges		22,400



(3) Half Facepiece Respirator, 6000 Series, Unmatched Performance and Comfort

(3) "3M" Half Facepiece Respirator, 6000 Series, Unmatched Performance and Comfort

- * The Swept Back Design of the Cartridges Improves Balance and Visibility.
- * Remarkably Comfortable, Soft, Lightweight Facepiece and Easy-to-Adjust Head Straps

	Ea.	Price, ₩
3M.03.5196 Respirator, Half Facepiece, 6100, Small, w/o Filter & Cartridges New		16,240
3M.03.5061 , 6200, Medium, w/o Filter & Cartridges		16,240
3M.03.5197 , 6300, Large, w/o Filter & Cartridges New		16,240

3M® Full Facepiece Respirator, Reusable, Silicone Faceseal and Nose Cup, Wide Field of View With Cool Flow® Valve, Direct Connection Cartridge, Can be Used with Filters & Cartridges, 호흡보호구



(1) Ultimate Full Facepiece Respirator, FF400, Scotchgard® Protector

- Easy Breathing, Comfortable and Durable Respiratory Protection and Ease of Cleaning.
- Unique Center Adapter to Direct Exhaled Breath and Moisture Downward
- Provides a Wide Field of View for Excellent Visibility.
- Suggested Applications : Abatement, Painting, Welding, Chemical handling, Battery manufacturing, Construction, Utilities, Mining, Pharmaceutical, Smelting

- * Reliable, Convenient Respiratory Protection when Combined with "3M" Particulate Filters or Cartridges.
- * Advanced Silicone Material for Increased Comfort and Greater Durability.
- * Comes with Reclosable Storage Bag * Can be Used Cartridges or Filters by Purpose of Use.
- * Cool Flow® Valve : Easy Breathing, Reducing Heat and Moisture Build-up for Cool, Dry Comfort.
- * NIOSH approved for negative pressure air purifying and positive pressure dual airline applications

(1) "3M" Ultimate Full Facepiece Respirator, FF400, Scotchgard® Protector

- * Scotchgard® Protector : Paint and Stain Resistant Lens, Bead up Liquids on the Surface, Can be Wiped off Easily.

- * Silicone Faceseal and Nose Cup Enhances Comfort and Durability.

<B4>

	Ea.	Price, ₩
3M.03.5198 Respirator, Full Facepiece, FF401, Small, w/o Filter & Cartridges New		287,000
3M.03.5062 , FF402, Medium, w/o Filter & Cartridges		287,000
3M.03.5199 , FF403, Large, w/o Filter & Cartridges New		287,000



(2) Full Facepiece Respirator, 6000 Series, Versatility for Many Environments and Applications

(2) "3M" Full Facepiece Respirator, 6000 Series, Versatility for Many Environments and Applications

- * Large Lens for Wide Field of View and Excellent Visibility.
- * Remarkably Comfortable, Soft, Lightweight Facepiece and Easy-to-Adjust Head Straps.

	Ea.	Price, ₩
3M.03.5201 Respirator, Full Facepiece, 6700, Small, w/o Filter & Cartridges New		173,600
3M.03.5063 , 6800, Medium, w/o Filter & Cartridges		173,600
3M.03.5202 , 6900, Large, w/o Filter & Cartridges New		173,600

3M® Versaflo™ Modular Respirator System, for Powered Air Purifying, Comfortable Protection against Multiple Hazards **NEW**
 Enables Improved Productivity in the Workplace, 전동식 마스크 시스템



① "S-433" ② "S-533"



③ "S-655" ④ "S-657"



⑤, ⑥ "BT-20 S/L"



⑦ "BT-30"

- 오염된 공기를 흡입한 후, 필터로 여과시켜 깨끗하고 습기 없는 쾌적한 공기를 작업자에게 공급
- 보호도가 높아 열악한 환경에서도 안전하게 작업자를 보호
- * Incorporates a Battery Powered Motorised Fan to Draw Air through a Filter
- * Suitable for Use over Long Shifts - Reduced Breathing Resistance * Can Offer Integrated Head, Eye and Face Protection

A. 3M® Versaflo™ Suspension Hood, S-Series HeadTop

- * KOSHA(Korea Occupational Safety Health Agency) & CE Certified * Comfortable * Slim Design * Improved Visibility
- * Lightweight & Loose-fitting * Excellent Field of View * Coverage of Head, Hair, Neck and Shoulders

(1) with Integrated Head Suspension, 고정형 머리지지대 타입

- 머리 및 목, 어깨까지 보호 가능하며 착용이 간단한 기본형 후드
- * ① Cover : Polypropylene Coated Non-woven Polypropylene / Visor : PETG
- * ② Cover : Polyurethane Coated Knitted Polyamide / Visor : Coated Polycarbonate

<B4>

- 3M.03.S433 ① Hood, Standard-type
 3M.03.S533 ② , Low-Lint type

Ea.	Price, ₩
	78,400
	106,400

(2) with Premium Head Reusable Suspension, 커버교체형 머리지지대 타입

- Head Suspension을 커버와 분리할수 있어서 후드커버를 자주 교환해서 사용하는 작업장에 적합
- ④ : 이중 가슴 덮개 처리되어 보호복 안으로 공기가 이동 할 수 있어 몸 전체에 송풍 가능
- * User Control of Airflow Location and Suspension Adjustments for Best Comfort and Custom fit
- * ③ Cover : Polypropylene Coated Non-woven Polypropylene / Visor : PETG
- * ④ Cover : Polypropylene Coated Knitted Polyamide / Visor : PETG

- 3M.03.S655 ③ Hood, Premium, Standard-type
 3M.03.S657 ④ , with Double Chest Shroud, 송풍형

Ea.	Price, ₩
	179,200
	191,800

B. 3M® Versaflo™ Polyurethane Breathing Tubes

- * ⑤, ⑥ BT-20 : Using the Increased Strength Spring, Complement the Shortcomings of the QRS tube's Internal Spring Pressing Well
- * ⑦ BT-30 : Remove the Inner Spring of BT-20, Elasticity, Self-Adjusting

- 3M.03.BT20S ⑤ Breathing Tube, Lightweight, L735mm, Small
 3M.03.BT20L ⑥ , L965mm, Large
 3M.03.BT30 ⑦ , Self-Adjusting (L525~850mm)

Ea.	Price, ₩
	71,400
	71,400
	85,400

C. 3M® Versaflo™ Powered Air Turbo Kit

- 3단계 유량 모드로 작업자가 원하는 유량으로 선택 가능 ■ 3가지 알람 기능 : 디스플레이, 경보음, 진동
- 필터 교체 표시를 통해 쉽게 필터 교체 시기를 확인 할 수 있음



"Air Turbo"

Alarm Function

Easy to Check Battery Status

Comfortable Airflow

- Three user selectable flow rates to maximise comfort
- Controlled airflow delivers steady flow as battery discharges or filter loads with particulates

Ease of Use

- Display shows battery charge status and particulate filter loading status during use
- Charge status is also indicated by a useful LED display on the battery
- No user calibration of turbo required
- Electronic audible, visual and vibratory alarm in case

Multiple Applications

- Easy clean belt – submersible belt with smooth surfaces allows easy, thorough cleaning
- High durability belt option for hot work or rugged environments provides greater durability and spark/flare resistance
- Suitable for shower decontamination and temporary submersion to aid cleaning
- For asbestos specific version, please see Individual Respirator

- Air Turbo Kit with : ① "TR-602E" Turbo, ② A2P Filter & Filter Cover, ③ "TR-6600" Prefilters(×10ea), ④ "TR-662" Spark Arrestors(×2ea), ⑤ "TR-627" Belt, ⑥ "TR-632 Battery", ⑦ "TR641E" Battery Charger Kit, ⑧ "BT-30" Adjustable Breathing Tube, ⑨ "TR-971" Airflow Indicator

- * Provide Protection Against Particles, Gases or Vapours * Comfortable Airflow
- * No User Calibration of Turbo Required * Easy to Clean with Water
- * Max. Using Time(Full Charge) : 19hr
- * Typical Application - Pharmaceutical Manufacturing, Demolition, Pulp & Paper Processing, Painting, Chemical Processing, Agriculture, Medical & Healthcare, Foundries



Belt for Easy Working



Filter & Prefilter

Filter Cover

Battery

C. "TR-619E"

- 3M.03.TR619E Powered Air Turbo Kit

Kit.	Price, ₩
	2,100,000

Articles

Cat. No

Description

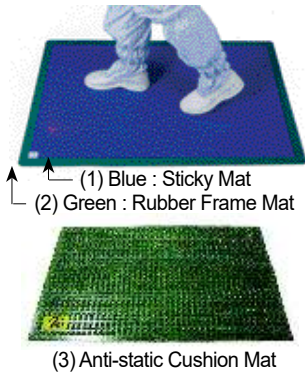

Sticky Mat, Class 1000, CleanRoom Products, 30 Layers, 점성이 있는 필름재질 매트, 정전기 방지

■ **Made in Korea** * Stop Dirt Contamination in the workplace
 * For Hospital, Operating Room, Pharmaceutical · Biological · Semiconductor · Electronic manufacturing. <L3>
 * 30 Layers : Use Each Sheet Many Times Before Peeling off.

- DH.Mat3001 (1) Sticky Mat, 600×900mm, t40 μ m **New**
- DH.Mat3002 (1) Sticky Mat, 600×900mm, t32 μ m **New**
- N4.002 (2) Mat, Rubber Frame

Ea. Price, ₩	Cs.	Price, ₩
6,820	10ea	63,010
6,050	10ea	56,000
81,680		

Anti-Static (Anti-static Cushion Mat)

* Fatigue Resistant, Comfort, Non-Slip, Safety Mat.

- N4.004 (3) Mat, Anti-static Cushion, 600×900×t13mm

Ea. Price, ₩
122,520



filtratech® Premium Bench Protective Paper, Sheet & Roll-Type, for Prevent Impacts, Acids, Toxic Made of an Absorbent Paper & PE-Coated Film, <France-made>, 프리미엄 실험실 벤치 보호 매트 NEW

■ 흡수성이 뛰어나 산, 유독성 유출물로부터 실험실 벤치 보호 및 실험자의 안전한 작업환경 유지
 ■ Efficient Protection of Laboratory Benches against Impacts, Acids, Toxic, Corrosive or Radioactive Fluids
 ■ With an Absorbent Paper on one Side and with a PE-coated Film on the other.
 ■ Absorption Capacity : 170 ml/m²
 * Weight Cellulose : 100g/m², PE : 25g/m²

(1) Sheet-Type

- FL.PP125.F46L Bench Protective Paper, Sheet-Type, 46×57cm, 50sheets

Pk. Price, ₩
50sheets 46,440

(2) Roll-Type

- FL.PP125.R46 Bench Protective Paper, Roll-Type, w460mm×L50m
- FL.PP125.R49 Bench Protective Paper, Roll-Type, w490mm×L50m

Roll. Price, ₩
50m 106,240
50m 112,340

Articles

Cat. No

Description

안전 지시봉등, Safety Rod Light CHINA

NEW



▲ WS-900

▲ WS-S900

- D타입 배터리 2개 사용 (별도구매)
- 원터치 전원버튼 적용
- 6LED 적용으로 장시간 사용 가능
- 지속 점멸, 지속 점등 2가지 모드

<B3>

ORDER NO.	MODEL NO.	PRICE, ₩ Ea.	규격(mm)	포장단위 Ea. / Cs.
▶ 0403-987	WS-900	4,810	540×43	1 / 50
▶ 0403-988	WS-S900	4,620	400×43	1 / 60

삼각대, Warning Triangle KOREA

SM

(1) 일반형



▲ WS-820

(2) LED 점등형



▲ WS-821

- (1) 일반형 : 불빛 반사를 위한 발광 반사 판사용, 쉬운설치
- (2) LED 점등/점멸형 : 고휘도 LED, AA×3ea(건전지 별매)

<B3>

ORDER NO.	MODEL NO.	PRICE, ₩ Ea.	규격(mm)	포장단위 Ea. / Cs.
▶ 0437-820	삼각대, 42×38cm, 일반형	5,930		
▶ 0437-821	, LED형	16,960		

플라스틱 체인, Plastic Chain KOREA

SM

NEW



▲ 백색/적색



▲ 형광

- 가격이 저렴하고 녹이 슬지 않아 반영구적임
- 사용이 가능하며, 색상이 밝고 선명
- 경계용, 차단용으로 사용

<B3>

ORDER NO.	색상	PRICE, ₩	타입	규격 (mm×M)
▶ 0438-089	○ 백색 ● 적색	43,330	롤	8×45
▶ 0438-102	● 형광			

칼라콘, 주차콘, Traffic Con KOREA

SM

NEW



▲ (1) 기본칼라콘

NEW



▲ (2) 스마트칼라콘

NEW



▲ (3) 사각주차콘

(1) & (2) 칼라콘

- 고휘도 반사지로 주, 야간 시인성이 우수
- 상단에 결이봉 연결이 가능
- 가벼우며 내구성이 뛰어나 설치 및 적재가 간편
- UV안정제로 탁색 및 변색이 없음

<B3>

ORDER NO.	색상	PRICE, ₩	규격(mm)
▶ 0437-907	(1) 기본칼라콘	4,220	380×380×700
▶ 0437-909	(2) 스마트칼라콘	9,110	380×700

(3) 주차콘

- 주차금지 안내, 기업홍보 효과
- 반사지에 인쇄되어 있어 시인성이 뛰어나
- 직사각형으로 시각성이 뛰어나
- 일체형으로 취급이 용이
- 강풍에도 넘어지지 않게 설계됨

▶ 0437-919	(3) 사각주차콘	17,560	450×450×1,100
------------	-----------	--------	---------------

형광반사 조끼, Fluorescent Vest KOREA

SM

NEW



▲ SM-401-1



▲ SM-402

- 신호수 안전 조끼로 반사띠가 부착되어있어 주,야간 식별 가능
- 뒷면에도 반사띠 부착
- 통풍 원활

<B3>

ORDER NO.	MODEL NO.	PRICE, ₩	규격	재질	포켓
▶ 0437-950		3,710	XL	천	3개
▶ 0437-951	SM-401-1		2XL	천	
▶ 0437-952			3XL	천	
▶ 0430-068			XL	망사	
▶ 0430-069	SM-402		2XL	망사	
▶ 0437-953			3XL	망사	

Articles

Cat. No

Description

NEW



(1) Standard type



(2) Premium type

3M® Scotchlite™ Reflective Safety Vest, Durable, Lightweight, Breathable Mesh, Lime Yellow NEW
 Protect from Safety Accident, 360° of Reflectivity, Comfortable, 반사안전조끼

- * Made of Solid
- * Lightweight Design for a Comfortable Fit

(1) Standard type, without Pocket & Zipper

- 2차 사고 예방을 위한 차량비치용, 개인안전용 ■ KC Certified
- * Personal Protective Equipment * Wearable, Convenient for Storage

<B4>

3M.03.5130 Safety Vest, Reflective, Standard type

Ea.	Price, ₩	Cs.	Price, ₩
	12,880	50ea	624,680

(2) Premium type, with Pocket & Zipper

- 건축, 토목, 도로상 작업 및 긴급상황, 안전요원등에서 사용되는 전문가용
- ANSI 107 & EN471 & KC Certified KC
- * Ideal for Road Work, Construction, Crossing Guards and More
- * High Quality and Durable

3M.03.5131 Safety Vest, Reflective, Premium type

Ea.	Price, ₩	Cs.	Price, ₩
	15,400	50ea	746,910

3M® Petroleum Sorbents, Extremely Absorbent, Hydrophobic, Lightweight, Dust Free **NEW**

Ideal for Absorbing Oil, Minimize the Amount of Waste for Disposal, 유흡착재, 환경 보호용

NEW



(1) Pad-type, 43×48cm

- 물은 빨아들이지 않고 기름만 흡착, 자체 중량의 20배 이상의 기름을 흡수하여도 물에 가라앉거나 찢어지지 않음
- 유조선 사고, 고속도로, 철도, 연안의 기름탱크, 산업오염 등 유출사고에 용이
- * Made from inert, Synthetic Fibers, these Sorbents are Available in a Wide Range of Formats to Enhance Spill Management and Maximize Pollution Control.
- * Controlling, Cleaning up and Recovering Oil and Petroleum Based Liquids from Effluent Discharge, Streams, Ponds, Lakes, Rivers, and Other Bodies of Water

(1) 3M® Petroleum Sorbent Pads, w43 × L48cm 패드타입

- 자체 중량의 20배가 넘는 기름을 흡착할 수 있는 고성능 패드
- 해양이나 강, 도로에서의 유출사고 발생시 가장 보편적으로 사용되며 설치 및 폐기처리가 신속용이
- * Absorb Hydrocarbon-based Liquids and Repel Aqueous-based Liquids
- * Reusable, Conveniently-sized * Absorption Capacity : 1L / pad

<B4>

Cs.	Price, ₩
100sheet	123,200

3M.03.HP156K Petroleum Sorbent Pads, 43cm×48cm, 45g/pad



(2) Roll-type, 96cm×44m

(2) 3M® Petroleum Sorbent Rolls, w96cm × L44m 롤타입

- 롤 타입은 넓은 지역으로 퍼진 유출 기름을 신속하게 제거
- 오일펜스나 붐의 앞뒤, 또는 강둑, 해안으로 밀려오는 기름을 흡착해 환경오염을 방지
- * Designed to Cover Large Surfaces * Easily Cut to Fit Tight Corners
- * Ideal for Absorbing Oil from Areas Where Water May also be Present
- * Absorption Capacity : 190L / Roll

Cs.	Price, ₩
1Roll	217,000

3M.03.HP100 Petroleum Sorbent Rolls, 96cm×44m, 10kg



(3) - ① Pillow-type, Large

(3) 3M® Petroleum Sorbent Pillows, 필로우 타입-대량 흡착용

① Large-type

- 필로우 타입은 다량의 기름을 제거하는데 사용
- 자외선에 의해서 변형되지 않고, 배 밑이나 하수구와 같이 손이 닿기 어려운 곳의 기름을 제거하는데 활용
- * Excellent for Handling Large Quantities of Light Oil in Confined Space
- * UV-Resistant and will not deteriorate or sink.
- * Small & Lightweight * Absorption Capacity : 13L / Pillow

Ea.	Price, ₩	Cs.	Price, ₩
25,710		10ea	238,000

3M.03.T240 Petroleum Sorbent Pillows, 35cm×63cm, 1kg/Pillow

② Small-type

- 작고, 가볍고, 잘 찢어지지 않으며, 패드형 흡착재의 수용능력 이상의 유출이 일어났을 때 이상적으로 사용될 수 있음
- * Small & Lightweight * Tear-Resistant
- * Feature a High Capacity for Holding Liquid * Ideal for Placing at the Source of a Leak
- * Used in Areas where More Capacity is Desired Than can Easily be Achieved Using a Sorbent Pad
- * Absorption Capacity : 2L / Pillow

Ea.	Price, ₩	Cs.	Price, ₩
10,590		16ea	156,800

3M.03.T30 Petroleum Sorbent Pillows, 23cm×38cm, 160g/Pillow

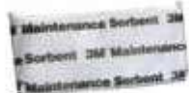

(3) - ② Pillow-type, Small



(4) - ① Boom-type, Large

(4) 3M® Petroleum Sorbent Booms, w20cm × 3m & w7.5cm × 1.2m 붐타입

① Large-type

- 강이나 해양에 장시간 떠있어도 가라앉거나 뒤틀리지 않음, 연결 고리로 원하는 길이만큼 이를 수 있음
- * Used to Stop the Spread of Liquids * First Line in Spill Containment
- * Booms Can be Linked Together by Built-in Connectors to Deploy Over Large Areas
- * Designed for Long-term Use in Ditches, Streams, Rivers, Lakes, Docks and Piers
- * UV-resistant, they will not Deteriorate or Disintegrate. * Absorption Capacity : 75L / Boom

Ea.	Price, ₩	Cs.	Price, ₩
98,280		4ea	364,000

3M.03.T270K Petroleum Sorbent Booms, 20cm×3m, 5kg/Boom

② Small-type

- 유출된 기름의 확산 억제 및 흡착기능을 동시에 할 수 있기 때문에 유출사고시 효과적으로 대체
- * Quickly Prevent Leaks and Spills from Spreading to Adjacent Areas
- * Absorption Capacity : 4L / Mini-Boom
- * Ideal for Placement Around Equipment to Prevent Damage

Ea.	Price, ₩	Cs.	Price, ₩
11,350		12ea	126,000

3M.03.T4 Petroleum Sorbent Mini-Boom, 7.5cm×1.2m, 360g/Boom



(5) Folded-type

(5) 3M® Petroleum Folded Sorbents, w12.5cm × L15.2m 패드/붐/필로우 타입 혼합형

- 용도에 따라 붐, 필로우, 패드 및 롤 형태로 펼쳐서 다양도로 사용가능
- 41cm마다 절단부가 있어 필요한 만큼 끊어 사용
- * Use as a Boom, Pillow, Pad or Roll. * Each Handy Dispenser Shows Suggestions for Sorbent Use
- * Absorption Capacity : 119L /Cs.

Pk.	Price, ₩	Cs.	Price, ₩
1roll	181,440	3pk	488,880

3M.03.PFL550DD Petroleum Folded Sorbents, 12.5cm×15.2m, 8kg

Articles	Cat. No	Description
----------	---------	-------------

3M® Chemical Sorbents, for Hazardous Spill Control, Provide High Absorption Capacity NEW

Suitable for Absorbing Chemical Liquids, Convenient, Rapid to Deploy, 케미컬 흡착재



(1) Pad-type, 28×33cm

- 화학 공장의 창고나 생산라인, 각종 연구실, 실험실 등 주로 화학약품을 다루는 곳에서 사용
- 산, 알칼리 등의 액체 유해물 외에도 거의 모든 형태의 액체를 흡착, 대부분의 화학물질과 결합하여도 화학반응을 일으키지 않음
- 흡착력이 강하며 빠르게 운반가능, 폐기처리 용이
- For Control and Clean-up of Most Hazardous Liquids
- * Can be Used with Many Aggressive Chemicals such as Acids and Alkalies
- * Immediate Response to Chemical Spillages
- * Fast and Effective Containment and Clean-up

(1) 3M® Chemical Sorbent Pads, w28×L33cm 패드 타입

- 패드 타입은 화학실험과 같이 좁은 장소에서 이용 용이
- 오염된 장비나 기계를 닦아 내는데 활용
- * Perfect for Cleaning up Small Spills and Wiping Contaminated Areas
- * Allow the User to Quickly Spread Sorbent on and in the Path of a Spill
- * Highly Absorbent, Featuring a Low Profile Design
- * Absorption Capacity : 0.3L / pad
- * Conveniently Sized and Packaged in a Dispenser Box

3M.03.P110K Chemical Sorbents Pad, 28×33cm, 26g/Pad

Cs.	Price, ₩
200Sheet	177,800



(2) Roll-type, 38.7×457cm

(2) 3M® Chemical Sorbent Rolls, w0.39×L45.7m 롤 타입

- 넓은 지역으로 번진 케미컬을 신속하게 흡착할 수 있으며 원하는 길이만큼 잘라 쓸 수 있어 사용하기에 편리함
- * For Fast Coverage of Large Surface Areas
- * Absorption Capacity : 117L / Roll
- * Offers the Versatility to Cut-for-Use in Small Areas or Lay Down Full Size for Larger Spills
- * Used as a Mat to Keep Shorelines or Banks Clean and to Place Used Sorbents Upon

3M.03.CRL15150DD Chemical Sorbent Rolls, 38.7×L457cm, 5.5kg

Cs.	Price, ₩
1Roll	182,000



(3) Mini Boom-type

(3) 3M® Chemical Sorbent Mini-Booms, w7.5cm×L1.2m 붐(할대) 타입

- 액체 유해를 보관이나 운송 시 유출된 케미컬이 더 이상 확산되지 않도록 억제하는데 쓰임
- * Ideal for Placing Around Hazardous Liquid Spills to Help Prevent Spreading
- * Absorption Capacity : 3.75L / Mini-Boom
- * Typically Used to Encircle Spills and to Contain Leaks

3M.03.P200 Chemical Sorbent Mini-Booms, 7.5cm×1.2m, 360g/Boom

Ea.	Price, ₩	Cs.	Price, ₩
	16,010	12ea	177,800



(4) Pillow-type

(4) 3M® Chemical Sorbent Pillows, 23×38cm 필로우(베개)형-대량 흡착용

- 필로우는 다량으로 유출된 케미컬을 신속하게 흡착함으로써 작업자를 안전하게 보호함
- * Pillows are Used in Areas where More Capacity is Desired than can Easily be Achieved Using a Sorbent Pad
- * Ideal for Placement at the Source of a Leak
- * Small, Lightweight, Tear-Resistant
- * Feature a High Capacity for Holding Liquid
- * Absorption Capacity : 1.85L / Pillow

3M.03.P300 Chemical Sorbent Pillow, 23×38cm, 160g/Pillow

Ea.	Price, ₩	Cs.	Price, ₩
	11,160	16ea	165,200



(5) Folded-type

(5) 3M® Chemical Folded Sorbents, w12.5cm×L15.2m 패드/붐/필로우 타입 혼합형

- 용도에 따라 붐, 필로우, 패드 및 롤 형태로 펼쳐서 다양도로 사용가능
- 41cm마다 절단부가 있어 필요한 만큼 끊어 사용
- * Made from Chemically Inert Polypropylene Material
- * Absorption Capacity : 119L / Cs.
- * Work Well with Chemicals such as Acids and bases as well as Aqueous or Hydrocarbon-based Fluids

3M.03.CFL550DD Petroleum Folded Sorbents, 12.5cm×15.2m, 8kg

Pk.	Price, ₩	Cs.	Price, ₩
1roll	210,000	3pk	611,110



(1) (2)

Liquid Absorbent Roll, Fibrous Polypropylene, Thick 3mm, w0.4×L50m/Roll, 7kg NEW
Capable of Absorbing Acid/Alkali and Oil/Solvent/Water, Excellent Absorption, 다기능 액체흡착재 롤

- 다양한 액체를 흡수할 수 있는 롤 형태의 흡착시트
- (1) SL.Sor3011 ; Absorbing Water, Oil, Solvent (2) SL.Sor3013 ; Absorbing Water, Oil, Solvent, Acid, Alkali
- * Made of PP(Polypropylene)
- * Absorption Amount : 73Lit/Roll
- * Perforated approximately every 50cm to tear off Single Sheets for Convenient Use

SL.Sor3011 (1) Liquid Absorbent Roll, for Water, Oil, Solvent
SL.Sor3013 (2) , for Acid, Alkali

Roll.	Price, ₩
50m	168,510
50m	275,110

※ Hammacher® Premium Maintenance Service for Diamond Coating, Sharpening, Refinishing & c.
⇒ See the “Forceps” Section.

Hammacher® Premium OP-Special Micro Super Cut Scissors, for All Surgical Uses, L105~140mm, *Medicaluse approved*
With Extra-sharp Tips · One Grip Ring Golden, Stainless-steel 420, <Germany-made>, 프리미엄 마이크로 슈퍼 컷 수술 가위, 독일제 의료용, 비부식 **NEW**

NEW

Medicaluse

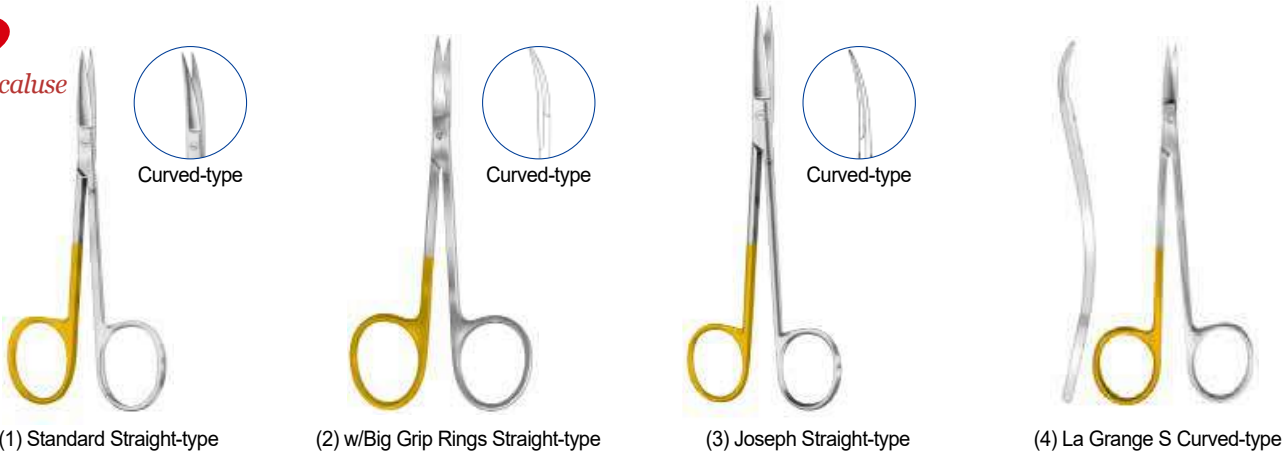

(1) Standard Straight-type

(2) w/Big Grip Rings Straight-type

(3) Joseph Straight-type

(4) La Grange S Curved-type

- Germany-made 프리미엄급; 비부식, 고강도, 고경도, 내약품성
- 절삭력을 높이기 위해 날 부분이 미세한 톱니 형태 (Super-cut)로 되어있고, 인체 조직을 섬세하고 부드럽게 자를 수 있어 통증을 줄임
- Surgical Stainless-steel 420: Rust-proof, High-Strength/Hardness, Chemical Resistance
- OP-SPECIAL Micro Super Cut Scissors ; Microsection – Super Cut – Extra Sharp – for all Surgical uses in Hospital and Private Practice

(1) Standard Scissors, L105mm * Ideal for Gum Surgery

		<M1>	
		Ea. Price, ₩	
HA.HSB390.10	Scissors, Standard, Extra-Sharp Tip, Straight, 105mm	59,040	
HA.HSB391.10	Scissors, Standard, Extra-Sharp Tip, Curved, 105mm	60,880	

(2) Big Grip Rings Scissors, L115mm

		Ea. Price, ₩	
HA.HSB0140.11	Scissors, w/Big Grip Rings, Extra-Sharp Tip, Straight, 115mm	69,340	
HA.HSB0141.11	Scissors, w/Big Grip Rings, Extra-Sharp Tip, Curved, 115mm	71,180	

(3) Joseph Scissors, L140mm

		Ea. Price, ₩	
HA.HSB400.14	Scissors, Joseph, Extra-Sharp Tip, Straight, 140mm	67,330	
HA.HSB401.14	Scissors, Joseph, Extra-Sharp Tip, Curved, 140mm	69,940	

(4) La Grange Scissors, S-Curved type, L115mm

		Ea. Price, ₩	
HA.HSB392.11	Scissors, La Grange, Extra-Sharp Tip, Straight, 115mm	91,920	

NEW Medicaluse

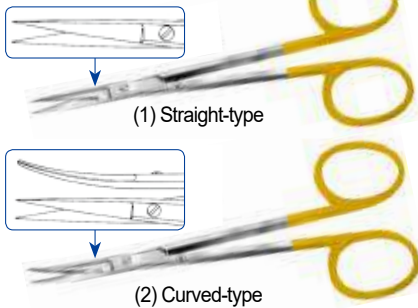

(1) Straight-type

(2) Curved-type

Hammacher® Premium TC Micro Operating Scissors, L115mm, *Medicaluse approved* **NEW**
With Sharp-Sharp Tip, SuperCut, Gold-plated Handle, <Germany-made>, 프리미엄 미세 수술용 TC 가위

- Germany-made 프리미엄급, 인체조직의 절단 및 절개 등에 사용
- 날 부분에 텅스텐 카바이드 (TC, Tungsten-Carbide)를 삽입시켜 스텐레스 재질보다 내구성이 뛰어나며 커팅날의 절삭력이 오래 지속됨
- with TC(Tungsten-Carbide) Inserts in the Blade, Uniform Long Lasting Cut
- The Scissors are deliverable also with “MICRO-TOOTHING”, i. e. Handy Cutting, No Slipping Off
- * TC Scissors are more Durable, Hold an Edge Longer and Last Longer than Steel Scissors. <M1>
- * Ideal for Gum Surgery

		Ea. Price, ₩	
HA.HSB300.11	Scissors, TC, Straight, Sharp-Sharp Tip, 115mm	104,510	
HA.HSB301.11	, Curved, Sharp-Sharp Tip, 115mm	113,130	

Hammacher® Premium Curved Foil / Splint Scissors, L105mm, *Medicaluse approved* **NEW**

For All types of Foil & Align Splints, with Mico-Saw edge, Stainless-steel 410, <Germany-made>, 프리미엄 호일 겸 부목 가위, 독일제 의료용, 비부식

NEW

Medicaluse



- Germany-made 프리미엄급; 비부식, 고강도, 고경도, 내약품성
- 인체조직의 절단 및 절개 등에 사용하거나 극도로 부드러운 재질 (Ex. 호일) 이나 부목을 자를 때 적합
- Stainless-steel 410 : Rust-proof, High-Strength/Hardness, Chemical Resistance <M1>

		Ea. Price, ₩	
HA.HSB630.10	Foil / Splint Scissors, SS, L105mm	53,810	

Articles	Cat. No	Description
----------	---------	-------------

Hammacher® Premium Microscopic Operating Scissors, L90~145mm, Medicaluse approved

With Sharp-Sharp/-Probe Pointed Tip, Stainless-steel 420, <Germany-made>, 프리미엄 정밀 미세 수술용 가위, 독일제 의료용, 비부식

Medicaluse

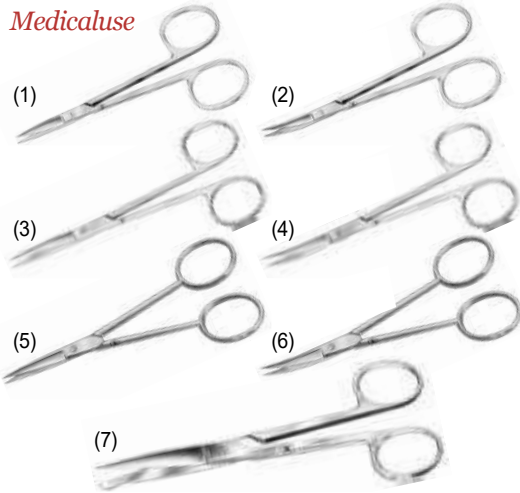

- Germany-made 프리미엄급; 비부식, 고강도, 고경도, 내약품성
- 인체조직의 절단 및 절개 등에 사용
- Surgical Stainless-steel 420: Rust-proof, High-Strength/Hardness, Chemical Resistance
- The Scissors are deliverable also with "MICRO-TOOTHING", i.e. Handy Cutting, No Slipping Off.

		<M1>
		Ea. Price, ₩
HA.HSB002.09	(1) Operating Scissors, Angular Handle, Straight, L90mm New	33,520
HA.HSB010.10	, L105mm New	39,060
HA.HSB012.11	, L115mm	51,660
HA.HSB003.09	(2) Operating Scissors, Angular Handle, Curved, L90mm New	35,680
HA.HSB011.10	, L105mm	40,750
HA.HSB013.11	, L115mm	52,880
HA.HSB014.11	(3) Operating Scissors, Round Handle, Straight, L115mm	52,420
HA.HSB015.11	(4) , Curved, L115mm	53,810
HA.HSB006.10	(5) Operating Scissors, Delicate, Straight, L110mm	56,890
HA.HSB007.10	(6) , Curved, L110mm	59,950
HA.HSB138.14	(7) Incision Scissors, Probe Pointed Tip, Straight, L145mm	54,720

Hammacher® Premium Operating Kelly & La Grange Scissors, L115 & 160mm, Medicaluse approved **NEW**

With Sharp-Sharp Tip, for Cutting Tissue · Sutures, Stainless-steel 420, <Germany-made>, 프리미엄 수술용 켈리 & 라그렌지 가위, 독일제 의료용, 비부식

NEW
Medicaluse



- Germany-made 프리미엄급; 비부식, 고강도, 고경도, 내약품성
- 인체조직의 절단 및 절개 등에 사용
- Surgical Stainless-steel 420: Rust-proof, High-Strength/Hardness, Chemical Resistance
- The Scissors are deliverable also with "MICRO-TOOTHING", i.e. Handy Cutting, No Slipping Off.

		<M1>
		Ea. Price, ₩
(1) Operating Kelly Scissors, Standard-/Sawedge-type, L160mm		
HA.HSB030.16	Scissors, SS, Kelly, Straight, L160mm	51,820
HA.HSB032.16	, w/Sawedge, L160mm	55,340
(2) Operating La Grange Scissors, S Curved-type, L115mm		
HA.HSB047.11	Scissors, SS, La Grange, S Curved, L115mm	76,250

Hammacher® Premium Suture & Ligature Spencer Scissors, with Suture Hook, L90 & 115mm, Medicaluse approved **NEW**

Used for Suture Removal, Stainless-steel 420, <Germany-made>, 프리미엄 수처 & 리게처 스펜서 가위, 봉합 및 지혈용, 독일제 의료용, 비부식

NEW Medicaluse

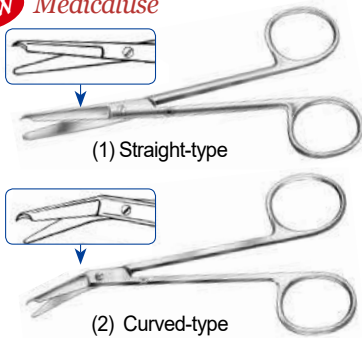

- Germany-made 프리미엄급; 비부식, 고강도, 고경도, 내약품성
 - 인체조직의 절단, 절개 및 실을 자를 때 사용
 - 갈고리 모양의 한쪽날을 봉합시 아래로 밀어 넣고 들어올려 실을 컷팅
 - Surgical Stainless-steel 420: Rust-proof, High-Strength/Hardness, Chemical Resistance
 - The Scissors are deliverable also with "MICRO-TOOTHING", i.e. Handy Cutting, No Slipping Off.
- * Suture Hook Shaped Tip on One Blade that Slides under Sutures to Slightly Lift them before Cutting for Removal

		<M1>
		Ea. Price, ₩
HA.HSB284.09	(1) Scissors, SS, Spencer, Straight, L90mm	53,810
HA.HSB286.12	(1) , L115mm	55,180
HA.HSB287.11	(2) , Curved, L115mm	61,180

Hammacher® Premium Micro-Serration Foil Scissors, L115mm, Medicaluse approved **NEW**

With Sharp-Sharp Tip, Stainless-steel 420, <Germany-made>, 프리미엄 미세 서레이션 호일 가위, 독일제 의료용, 비부식

NEW
Medicaluse



- Germany-made 프리미엄급, 인체조직의 절단, 절개 및 극도로 부드러운 재질(ex.호일)을 자를 때 사용하는 스텐 가위
- * Used to Precisely cut Excess Material from Soft Forming's.
- * Micro Serration Prevents Slipping

		<M1>
		Ea. Price, ₩
HA.HSB018.11	Foil Scissors, SS, Straight, L115mm	51,660

NEW

Medicaluse



Operating *Iris* Eye Scissors, Stainless-steel 420, L110mm, *Medicaluse* NEW
With Sharp-Sharp Tip, Very Delicate, 수술용 아이리스 가위, 의료용, 비부식

- Surgical Stainless-steel 420 : 비부식, 고강도, 고경도, 내약품성
- 아주 작은 조직을 섬세하게 잘라낼 때 사용하며 가장 보편적으로 안과에서 사용하나 정교함이 요구되는 성형외과, 피부과에서도 사용

■ Surgical Stainless-steel 420 : Rust-proof, High-strength / Hardness, Chemical Resistance <M1>

* Used in Ophthalmic Surgery

DM.04.1105 Scissors, Stainless-steel, Iris, Straight, L110mm

Ea.	Price, ₩
	4,340

NEW

Medicaluse



Operating *Stevens* Tenotomy Scissors, Stainless-steel 420, L115mm, *Medicaluse*
With Tapered Sharp-Sharp Tip, Curved-ended, 수술용 스티븐스 테노토미 가위, 의료용, 비부식

- Surgical Stainless-steel 420 : 비부식, 고강도, 고경도, 내약품성
- 안과, 성형외과, 신경외과 수술 등 매우 정교한 수술에 사용
- Surgical Stainless-steel 420 : Rust-proof, High-strength / Hardness, Chemical Resistance

* Used in Plastic Surgery and Hand Surgery for Cutting with Extreme Precision in Small Incisions <M1>

DM.04.1108 Scissors, Stainless-steel, Steven, Curved-ended, L115mm

Ea.	Price, ₩
	6,700

NEW

Medicaluse



Operating *Mayo* Scissors, Stainless-steel 420, L145 & 230mm, *Medicaluse* NEW
With Blunt-Blunt Tip, for Cutting · Dissecting Tough Tissue, 수술용 메이요 가위, 의료용, 비부식

- Surgical Stainless-steel 420 : 비부식, 고강도, 고경도, 내약품성
- 외과수술에서 일반적으로 많이 사용하며 근막이나 근육과 같은 두꺼운 조직의 절개 및 절제에 이용
- Surgical Stainless-steel 420 : Rust-proof, High-strength / Hardness, Chemical Resistance

* Ideal for Cutting and Dissecting Tough Tissues in Surgical Procedures <M1>

DM.04.1110 Scissors, Stainless-steel, Mayo, Straight, L145mm

DM.04.1113 , L230mm

Ea.	Price, ₩
	12,990
	13,770

NEW

Medicaluse



Operating *Metzenbaum* Scissors, Stainless-steel 420, L200mm, *Medicaluse* NEW
With Rounded Blunt-Blunt Tip, for Fine Cutting · Dissecting Tissue, 수술용 메첸바움 가위, 의료용, 비부식

- Surgical Stainless-steel 420 : 비부식, 고강도, 고경도, 내약품성
- 가위 볼 표면이 둥글고 얇아 복막과 내부 장기와 같은 섬세한 조직의 절개에 사용하며, 조직 해부 시 가장 일반적으로 사용
- Surgical Stainless-steel 420 : Rust-proof, High-strength / Hardness, Chemical Resistance

* More Delicate than Mayo Scissors * for Cutting Delicate Tissue and Blunt Dissection <M1>

* Used in Organ-related Operation

DM.04.1123 Scissors, Stainless-steel, Metzenbaum, Straight, L200mm

Ea.	Price, ₩
	14,950

NEW

Medicaluse



Operating *Dean* Tonsil Scissors, Stainless-steel 420, L180mm, *Medicaluse* NEW
With Upward Angled Sharp Tip, S-curved Type, 수술용 딘 편도 가위, 봉합용, 의료용, 비부식

- Surgical Stainless-steel 420 : 비부식, 고강도, 고경도, 내약품성
- 수술 시 연한 조직을 잘라내고 다듬거나 봉합사를 절단하는 데 사용, 구강의 조직을 잡고 제거하는 데에도 사용
- 구강 뒤쪽에 있는 조직에 쉽게 접근할 수 있도록 위쪽으로 각진 블레이드 구조를 가짐
- Surgical Stainless-steel 420 : Rust-proof, High-strength / Hardness, Chemical Resistance

* Designed with an Upward Angled Tips which Allows Easy Access of Structures at the Back of the Oral Cavity * Used for Trimming Tissue or Cutting Sutures <M1>

DM.04.1130 Scissors, Stainless-steel, Dean, S-Curved, L180mm

Ea.	Price, ₩
	9,840

Articles	Cat. No	Description																																																	
NEW (1) Straight, Blunt-Blunt	<i>Medicaluse</i>	Operating Scissors, Stainless-steel 420, L130~175mm, <i>Medicaluse</i> NEW With 3-type Tips, Straight- & Curved-type, 수술용 외과가위, 의료용, 비부식																																																	
(2) Straight, Sharp-Blunt		<ul style="list-style-type: none"> ■ Surgical Stainless-steel 420 : 비부식, 고강도, 고경도, 내약품성 ■ 진료 또는 수술 시 사용되는 기구로 3가지 타입의 팁 선택 가능 ■ Surgical Stainless-steel 420 : Rust-proof, High-strength / Hardness, Chemical Resistance <M1> * Commonly Using for Surgical Instrument																																																	
(3) Straight, Sharp-Sharp			<table border="1"> <thead> <tr> <th>Ea.</th> <th>Price, ₩</th> </tr> </thead> <tbody> <tr> <td></td> <td>4,180</td> </tr> <tr> <td></td> <td>4,300</td> </tr> <tr> <td></td> <td>4,370</td> </tr> <tr> <td></td> <td>4,410</td> </tr> <tr> <td></td> <td>4,650</td> </tr> <tr> <td></td> <td>4,770</td> </tr> <tr> <td></td> <td>4,880</td> </tr> <tr> <td></td> <td>5,000</td> </tr> <tr> <td></td> <td>5,240</td> </tr> <tr> <td></td> <td>5,350</td> </tr> <tr> <td></td> <td>5,470</td> </tr> <tr> <td></td> <td>5,600</td> </tr> <tr> <td></td> <td>5,830</td> </tr> <tr> <td></td> <td>5,950</td> </tr> <tr> <td></td> <td>6,070</td> </tr> <tr> <td></td> <td>6,190</td> </tr> <tr> <td></td> <td>6,420</td> </tr> <tr> <td></td> <td>6,660</td> </tr> <tr> <td></td> <td>6,770</td> </tr> <tr> <td></td> <td>7,010</td> </tr> <tr> <td></td> <td>7,130</td> </tr> <tr> <td></td> <td>7,240</td> </tr> <tr> <td></td> <td>7,360</td> </tr> </tbody> </table>	Ea.	Price, ₩		4,180		4,300		4,370		4,410		4,650		4,770		4,880		5,000		5,240		5,350		5,470		5,600		5,830		5,950		6,070		6,190		6,420		6,660		6,770		7,010		7,130		7,240		7,360
Ea.	Price, ₩																																																		
	4,180																																																		
	4,300																																																		
	4,370																																																		
	4,410																																																		
	4,650																																																		
	4,770																																																		
	4,880																																																		
	5,000																																																		
	5,240																																																		
	5,350																																																		
	5,470																																																		
	5,600																																																		
	5,830																																																		
	5,950																																																		
	6,070																																																		
	6,190																																																		
	6,420																																																		
	6,660																																																		
	6,770																																																		
	7,010																																																		
	7,130																																																		
	7,240																																																		
	7,360																																																		
(4) Curved, Blunt-Blunt																																																			
(5) Curved, Sharp-Blunt																																																			
(6) Curved, Sharp-Sharp																																																			

Hammacher® Premium Dental Crown Scissors, L100 & 120mm, *Medicaluse approved*

For Cutting Dental Dam · Wire · Crown · Plate, Stainless-steel 420, <Germany-made>, 프리미엄 크라운 가위, 독일제 의료용, 비부식

<i>Medicaluse</i>					
(1) Beebee, Straight-type	(2) Beebee, Curved-type	(3) Special, Curved-type	(4) Universal, Curved-type		
<ul style="list-style-type: none"> ■ Germany-made 프리미엄급; 비부식, 고강도, 고경도, 내약품성 ■ Crown 또는 Gold Metal 등을 자르거나 다듬을 때 사용 ■ Surgical Stainless-steel 420: Rust-proof, High-Strength/Hardness, Chemical Resistance 				<M1>	
HA.HSB648.10	(1) Crown Scissors, SS, Beebee, Straight, L100mm New				36,910
HA.HSB649.10	(2) , Curved, L100mm New				38,130
HA.HSB653.10	(3) , Special, Curved, Sharp Tip, L100mm				55,180
HA.HSB659.12	(4) , Universal, Curved, Saw Edge Tip, L120mm				61,340

Hammacher® Premium Micro Tissue Scissors, with Spring Action Handle, L90 & 105mm, *Medicaluse approved* **NEW**

Extremely Smooth Cutting of Tissue, Stainless-steel 420, <Germany-made>, 프리미엄 마이크로 티슈 가위, 독일제 의료용, 비부식

<i>Medicaluse</i>		<ul style="list-style-type: none"> ■ Germany-made 프리미엄급; 비부식, 고강도, 고경도, 내약품성 ■ 조직의 절단, 절개 및 실을 자를 때 사용 ■ Surgical Stainless-steel 420: Rust-proof, High-Strength/Hardness, Chemical Resistance <M1>
HA.HSB500.09	Micro Scissors, SS, Straight, L90mm, Cutting Blade-L10mm	272,650
HA.HSB504.10	, L105mm, Cutting Blade-L10mm	244,380

Articles

Cat. No

Description

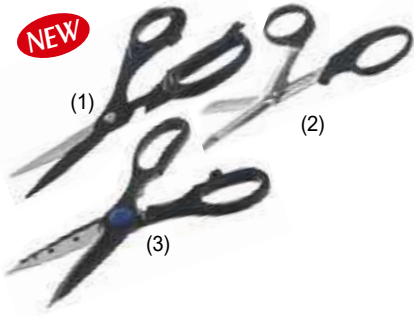

Bochem® Universal Laboratory Scissors, with Plastic Handle, L180~210mm NEW
 With 3-type Tips, Up to Max 145°C Resistant, Stainless-steel 430, **다용도 실험실 가위**

■ Supplied by Bochem® in Germany
 ■ 다용도 실험실 가위로써 절삭력이 우수함

BC.4150 (1) Scissors, Blunt-Blunt Tip, L200mm, Blade L70mm
 BC.4151 (2) , Sharp-Blunt Tip, Angle-134°, L180mm, Blade L60mm
 BC.4154 (3) , Sharp-Sharp Tip, L210mm, Blade L70mm

Ea.		Price, ₩
		23,720
		14,490
		21,100

<L1>

KDY 전공용 다기능가위, Multifunction Electric Scissors

다국적



■ 스트리핑범위 (AWG) : 22~10
 ■ 편리한 와이어 스트리핑
 ■ 강력한 와이어 압착
 ■ 압착범위 : 0.5~2.0v
 ■ 깔끔한 커팅
 ■ 인체공학 설계된 편안한 그림

<B3>

ORDER NO.	MODEL NO.	PRICE, ₩ Ea.	전장(mm)	포장단위 Ea. / Pk.
0480-329	KSS-200	11,760	200	1 / 10

IRWIN 항공가위(철판용), Aviation Tin Snip

U.S.A.



▲ 103(직선)

▲ 101(오른손)

▲ 102(왼손)

■ 톱니모양의 특수 설계 날로 절단시 미끄럼 없이 부드러운 커팅 능력을 보이며 인체공학적인 손잡이는 오랜 작업에서도 피로감을 줄여줄 뿐만 아니라 적은 힘으로도 손쉽게 작업 할 수 있어 남녀 누구에게나 편안함을 주는 강력한 항공가위

<B3>

ORDER NO.	MODEL NO.	PRICE, ₩ Ea.	색상	사용구분	포장단위 Ea. / Pk.
▶ 0111-920	103	20,300	노랑	직선용	1 / 5

ORDER NO.	MODEL NO.	PRICE, ₩ Ea.	색상	사용구분	포장단위 Ea. / Pk.
▶ 0111-917	101	20,300	빨강	오른손용	1 / 5
▶ 0111-918	102	20,300	녹색	왼손용	1 / 5

KDY 다용도 가위, Multiuse Scissors, Stainless-Steel

다국적



■ 수공예, 공작, 원예 등 다양한 작업이 가능한 멀티 가위
 ■ 스테인리스 재질

<B3>

ORDER NO.	MODEL NO.	PRICE, ₩ Ea.	날장 (mm)	전장 (mm)	포장단위 Ea. / Pk.
0403-554	KMS-190	3,530	57	190	1 / 12

KDY 전정가위, Pruning Shears

KOREA



■ 오토락
 ■ 다이캐스팅 손잡이
 ■ 무전해 Ni 도금
 ■ 고무 코팅그립

<B3>

ORDER NO.	MODEL NO.	PRICE, ₩ Ea.	날장 (mm)	전장 (mm)	포장단위 Ea. / Pk.
0260-839	S-880	10,490	55	210	1 / 10

KDY 적과가위, Picking Shears

다국적



■ 과수원에서 과일 따기 및 잔가지 제거용

<B3>

ORDER NO.	MODEL NO.	PRICE, ₩ Ea.	포장단위 Ea. / Pk.
0403-555	KHS-190	2,750	1 / 12

Articles	Cat. No	Description
----------	---------	-------------

DAIHAN® Microplate Mixer “MixM-1500”, with the Microplate Clamp, Orbital Motion, Max. 1,500rpm NEW
 For Holding Single or Double Microplates, Continuous Operation, **마이크로 플레이트 믹서, 마이크로 플레이트 클램프 포함**



Microplate Mixer, “MixM-1500” with (1) Single Microplate Clamp (Included)

※ Microplate is not Included

2-Year Warranty

- CE Certified
- 마이크로 플레이트용 소형믹서로 생명과학분야에서 널리 사용됨.
- * Widely Used in Life Sciences Including Microbiology, Cell and Molecular Biology, Immunology, and Biotechnology.
- * Compact Shape of Microplate Mixer. * Various Mixing Applications with Optional Adapters.
- * Maintenance-free Brushless DC Motor

Specifications & Ordering information <L1>

Spec.	Model	“MixM-1500”
Speed Range		Single Microplate : 0~1,500rpm Double Microplate : 0~1,000rpm
Shaking Motion		Orbital (Dia. 4.5mm)
Max. Shaking Weight		0.5kg (with Accessory)
Motor Type		Brushless DC Motor
Motor Rating (Input/Output)		18W / 10W
Ambient Temp & Humidity		5℃~40℃ & 80%RH
Dimension & Weight		260 × 150 × h80mm & 3kg
Power Consumption		20W
Electric Reqts.		110V-220V, 50Hz/60Hz
Cat. No.		DH.MixM1500
Price, Each. ₩		300,570

Optional Accessory



Fig 1. with (2) Double Microplate Clamp



Fig 2. with (3) Universal Top Plate & (8) Tube Adapter

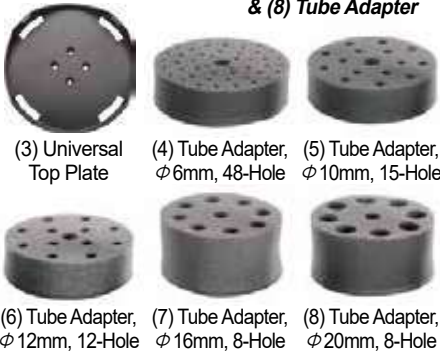

Spare Microplate Clamp

DH.Cla7001 (1) Single Microplate Clamp “PS1.2”

Ea.	Price, ₩
	7,800

Optional Accessory

- DH.Cla7002** (2) Double Microplate Clamp “MXM-116”
- DH.Cla7003** (3) Universal Top Plate “PS1.1”, Used with Tube Adapter
- DH.Ada6001** (4) Tube Adapter, for Test Tube “VT1.3.1”, φ6mm, 48-Hole
- DH.Ada6002** (5) “VT1.3.2”, φ10mm, 15-Hole
- DH.Ada6003** (6) “VT1.3.3”, φ12mm, 12-Hole
- DH.Ada6004** (7) “VT1.3.4”, φ16mm, 8-Hole
- DH.Ada6005** (8) “VT1.3.5”, φ20mm, 8-Hole

Ea.	Price, ₩
	8,910
	7,800
	11,140
	11,140
	11,140
	11,140
	11,140

DAIHAN® Premium Digital Tube Roller, “MixR-T6”, with 6 Mixing Rollers, Rocking & Rolling Motion, Speed Range 10~70rpm NEW
 Ideal for Mixing Blood Sample · Viscous Substance · Liquid-Solid Suspension, **디지털 튜브 롤러, LCD 디스플레이**



Premium Digital Tube Roller, “MixR-T6”

2-Year Warranty

- CE Certified
- 혈액 샘플, 점성 물질 및 액체-고체 서스펜션의 혼합과 응고/침전 방지 등에 매우 효율적인 롤링 동작을 제공.
- * Used in a Variety of Applications, such as the Prevention of Blood Coagulation, Immune Precipitation, etc.
- * LCD Displays the Speed and Time * Six Roller Design for Gentle Rolling and Easy to Clean.

Specifications & Ordering information <L1>

Spec.	Model	“MixR-T6”
Speed Range		10~70rpm
Mixing Roller Length		L280mm
Max. Load Capacity		4 kg
Ambient Temp & Humidity		5℃~40℃ & 80%RH
Motor Type		DC Motor
Operation Mode		Continuous / Timer
Timer Setting Range		1~1199 min
Dimension & Weight		450 × 260 × h120mm, 5.1kg
Power Consumption		30W
Electric Reqts.		110V-220V, 50Hz/60Hz
Cat. No.		DH.MixR1070
Price, Each. ₩		576,100



3M® Premium 5" Safety Shoes "Light Step S", Durable, Ultra Lightweight, 235~290mm **NEW**
 Ideal for Light Duty Utility, Non-slip, Wearable, Less Feet Fatigue, 초경량 안전화

- 미끄럼 방지 강화, 최상의 쿠션감으로 발의 피로도 감소, 통풍성 우수
- 스카치라이트(Scotchlite™)의 기술력인 반사소재 부착으로 야간활동에서 착용자의 안전성을 높임 ■ Made in Korea
- * 3M Glass Bubble : High-strength, Low-density Hollow Glass Microspheres Made from Soda-Lime Borosilicate glass Nonporous, Chemically Stable and Provide Excellent Water and Oil resistance
- * Material : Upper- Cordura Fabric(More Durable than Nylon) + Synthetic Leather, OutSole - Rubber & Glass Bubble + EVA
- * Excellent Ventilation with Cordura Fabric * Comfortable & Wearable * Suitable for Night Work

※ Please Note! when Ordering, Need to Specify Desired Size(mm)! <B4>

	Ea.	Price, ₩
3M.03.5213 Safety Shoes, 5", Brown, 235~290mm		77,000

Buffalo® 4인치 높이 안전화, 4" Height Safety Shoes **NEW**

(1) 뉴스피카 "BFL-403", 트레킹화 겸용, 메쉬원단, 신끈 방식



- * Navy+Yellow색, 액션누벅+메쉬원단, 통기성 우수
- * Sole/밑창; 파일론+Rubber, 아웃솔 장착, 충격흡수/미끄럼 & 오일 방지
- * 샌드 메쉬 원단 사용 통풍 우수성과 경량화
- * 패션 트레킹화 컨셉 평상화, 안전투우 캡 적용

	Ea.	Price, ₩
BFL.403 Safety Shoes, 4", Size 240~285mm (5mm 단위)		39,320

(2) 뷰티 "BFL-410", Premium형, 메쉬원단, Dial 신끈 방식



- * Violet색, 액션누벅+에어메쉬, 통풍성 우수
- * Sole/밑창; 파일론+Rubber, 아웃솔 장착, 충격흡수/미끄럼&오일 방지
- * 에어 메쉬 원단 사용 통풍 우수성과 경량화
- * Dial 신끈 편리한 착화/탈화, 안전투우 캡 적용

	Ea.	Price, ₩
BFL.410 Safety Shoes, 4", Size 240~285mm (5mm 단위)		45,360

Buffalo® 6인치 높이 안전화, 6" Height Safety Shoes **NEW**

(1) 스톤 "BFL-630", 편리형, 가죽, 2중 벨크로 방식



- * Dark Navy색, Artificial Leather 가죽+합성섬유
- * Sole/밑창; 인젝션+Rubber, 아웃솔 장착, 충격흡수/미끄럼&오일 방지
- * 고탄성 연질 PU사용 충격흡수력 우수, 경량화
- * 신끈없이 "2중 벨크로" 방식의 편리성, 안전투우 캡 적용

	Ea.	Price, ₩
BFL.630 Safety Shoes, 6", Size 240~285mm (5mm 단위)		33,270

(2) 메이드 "BFL-603", Premium형, 가죽, 신끈+지퍼 방식



- * Brown색, Artificial Leather 가죽+합성섬유
- * Sole/밑창; 인젝션+Rubber, 아웃솔 장착, 충격흡수/미끄럼&오일 방지
- * 고탄성 연질 PU사용 충격흡수력 우수, 경량화
- * 야간식별 반사띠 부착, 안전투우 캡 적용

	Ea.	Price, ₩
BFL.603 Safety Shoes, 6", Size 240~285mm (5mm 단위)		31,760

Spare Shoe Insole, Grey 신발 깔창



- * Model : BFL-Insole B
- * Material; 메리메쉬+오솔라이트
- * 편안함과 통기성 우수

	Ea.	Price, ₩
BFL.InsoleB 깔창 오솔라이트, Size 240~285mm (5mm 단위)		2,280

3M® Shoe Insole, Dual Pad System, 프리미엄 신발 깔창



- * 발의 아치와 뒤꿈치에 위치한 2개의 에어백으로 하중을 받쳐줌
- * 발을 안정적으로 지탱해줘 오래 신어도 편안함
- * Wearable, Comfortable, Less Fatigue

	Ea.	Price, ₩
3M.03.5212 Insole, Size 240~270mm (5mm 단위)		14,000

Articles Cat. No Description

SM 안전장화, Safety Boots

NEW  (1) 패션장화

- 재질 PVC
- 인체공학적 설계로 착용시 발이 편안함
- 코팅 안감처리로 착용이 간편함

▶ 빨강

<B3>

ORDER NO.	규격(mm)	PRICE, ₩	색상
▶ 0438-200	230~245	9,310	● 빨강
0438-190	245~290	9,310	● 파랑

NEW  (2) 요딩장화

- 인체공학적 설계로 착용시 발이 편안함
- 상단 카프 부착으로 이물질 침투 방지
- 미끄럼방지 기능
- 요딩장화 : 끈이 달려있어 물이 들어가지 않는 경작업용 장화

ORDER NO.	규격(mm)	PRICE, ₩	색상
0438-187	230~300	38,520	블루

NEW  (3) 수장화

- 고무 + PVC
- 가벼우며 내구성 우수
- 허벅지까지 보호

<B3>

ORDER NO.	규격(mm)	PRICE, ₩ Ea.	포장단위 Ea. / Cs.
0472-580	250~285	17,560	1 / 10

NEW  (4) 가슴장화

- 고무 + PVC
- 가벼우며 내구성 우수
- 미끄럼방지 기능

<L1>

ORDER NO.	규격(mm)	PRICE, ₩ Ea.	포장단위 Ea. / Cs.
0438-204	250~290	18,630	1 / 10

NEW  Antistatic Polyester & Carbon Clean Room Shoe Cover **NEW**
Clean Class 10,000, 크린룸/정전기 방지 신발 커버

- 정전기 방지 ■ 단층구조 잠섬유 부직포로 제조되어 작업자의 공정보호에 효과적 ■ 분진 및 소량의 액상물질 방어에 적합
- * Anti-electrostatic. Conductive Filament Yarn Piece
- * Dyed 100% Polyester & Carbon.

DH.App3501 Shoe Cover, for Clean Room

Pk.	Price, ₩	Cs.	Price, ₩
50pair	14,630	10pk	135,460

<L1>

NEW  **3M® Disposable Boot-/Shoe- Cover, Type 5 & 6, Durable, Low Linting Fabric** **NEW**
Anti-static, Lightweight, Universal size, White, 일회용 정전기 방지 신발/부츠 커버

- 내구성 및 보호도가 우수
- * Type 5 - Particle Protection / Type 6 - Limited Liquid Splash Protection
- * Ideal for Protection Particles & Chemical Liquids * Easy to ON & Off

(1) Polyethylene Shoe Cover

(1) Polyethylene Shoe Cover

- * Fits Securely around the Ankle with Elasticized Band * Anti-static Treated

3M.03.442 Shoe Cover, PE

(2) Polyethylene Boot Cover

(2) Polyethylene Boot Cover

- * Provide Excellent Protection * Comfortable Fit * Easy to Wear
- * Anti-static treated * Full Coverage

3M.03.440 Boot Cover, PE

(3) PVC Non-slip Boot Cover

(3) PVC Non-slip Boot Cover

- * Slip Resistant Sole to Help Improve User Safety
- * Good Fit for a Wide Range of Users

3M.03.450 Boot Cover, Microporous Laminate, Non-slip

Ea.	Price, ₩
	890

Ea.	Price, ₩
	1,340

Ea.	Price, ₩
	2,670

<B4>



8-layer Test Sieve
φ 75~203mm, Sieve Shaker



Spare; Accessory Kit

DAIHAN® Digital Vibrating Sieve Shaker, for up to 8-layer φ 75/203mm Test Sieve **NEW**
Ideal for Sieving · Classifying · Filtering, CE Certified, without Sieves, 시브쉐이커, 최대 8단, 표준망체 별도구매

- 강력한 진동으로 시료의 체 분리에 이상적이며 화학 산업 및 연구소 체 시험에 적합
- CE Certified
- Ideal for Effective Sieving, Classifying and Filtering Materials in the Test Sieve in Chemical Industry and Lab.
- * High Efficiency, Elaborate Design and Durable
- * Any Powder or Liquid can be Sieved.
- * Max. 8-layer Test Sieve(Including the Sieve Pan & Cover) can be Placed.
- * Accurately Separate one kind of Particle into 2~7 Particle Segments at the same time.
- * Can be Shut Down Automatically at time.
- * Can Experiment Repeatedly.
- * Full Functionality and Simpler Operation.
- * Timer Range: within 0~99min. and 0~59sec
- * Universal Supply : 230V- 50Hz/60Hz
- * Wooden Packing
- * Not Including Sieves
- ※ Must be Tightened the Locking Nuts on both Sides to Prevent Sieve's Departure.

Specifications & Ordering information

<L1>

Spec.	Model	"SieS0200"
Adjustable Sieve Diameter		φ 75~203mm
Sieving Particle Size		0.025~25mm
Motor Power		0.12(0.15 Common Motor)kw
Noise		Less than 50dB
Amplitude		0~3mm
Vibration Frequency		1400 Vibrations/min (Approx. 23Hz)
Dimensions (w×d×h) & Weight		350×380×h300mm, 35kg
Power Supply		230V-50Hz/60Hz
Cat. No.		DH.SieS0200
Price, Each. ₩		1,719,660

Accessory

DH.Sie8200 Spare; Accessory kit (2×Rod, 1×Rod Jig, 4×Clamps) for SieS0200

Ea.	Price, ₩
	403,060

Round-type Mesh Basket, Stainless-steel, with or without Hanging Loop & Handle, φ 205~260mm
Ideal for Washing · Drying · Storage &c., Lightweight, Durable, 원형 메쉬 바구니 **NEW**

- Made in Korea * 과일, 채소 등을 씻어 건조하고 위생적으로 보관하는데 용이
- * Good for washing and drying fruits, vegetables, etc.

(1) with Hanging Loop, without Handle

<B3>

DH.Bas7001 Mesh Basket, Round-type, Stainless-steel, φ 205×h80mm
DH.Bas7002 , φ 230×h90mm
DH.Bas7003 , φ 255×h100mm

Ea.	Price, ₩
	5,390
	5,830
	6,270

(2) with Handle, without Hanging Loop

DH.Bas7006 Mesh Basket, Round-type, Stainless-steel, φ 205(w/Handle 240)×h80mm
DH.Bas7007 , φ 230(w/Handle 265)×h90mm
DH.Bas7008 , φ 260(w/Handle 295)×h100mm

Ea.	Price, ₩
	6,270
	6,990
	7,870

Stainless-steel Mesh Strainer, Rustless, with Hanging Loop & Handle, φ 173~275mm **NEW**
Ideal for Washing · Drying · Storage &c., Lightweight, Durable, 건지기/망체

- Made in Korea * 덩어리진 가루를 곱게 치거나 음식물을 건지고 불순물을 걸러내는데 적합
- * with Hanging Loop

DH.Bas7011 (1) Mesh Strainer, Stainless-steel, φ 173×h75×L313mm
DH.Bas7012 (2) , φ 225×h50×L367mm
DH.Bas7013 , φ 230×h75×L420mm
DH.Bas7014 , φ 275×h75×L465mm

Ea.	Price, ₩
	5,540
	6,990
	7,870
	8,740

PET Sieve Brush, with Wood Handle, Bristle φ 25×L50mm, Total Length 210mm **NEW**
Ideal for Removal Sieve Clogging & Corner, Hair Thickness 0.2~0.4mm, 시브 브러쉬, 체는 막힘 제거용

- 시브 메쉬에 따라 전용 크기의 브러쉬 사용 가능
- * Material : Bristle/PET(Polyethylene terephthalate), Grip/Wood, Tip/Tin-rolled

SL.Bru3041 Sieve Brush, for 400~125 Mesh , Hair Thickness 0.2mm
SL.Bru3042 , for 100~65 Mesh , Hair Thickness 0.3mm
SL.Bru3043 , for 50 or less Mesh , Hair Thickness 0.4mm

Ea.	Price, ₩
	17,200
	17,200
	17,200

Articles	Cat. No	Description
----------	---------	-------------

SAUTER® Professional Sound Level Meter, 30~130dB, 0.1dB Readout NEW
 With Multi Measuring Functions, Selectable Methods of Evaluation, 프로페셔널 소음계

NEW



Professional Sound Level Meter



Carrying Case

■ **Supplied by SAUTER® in Germany**

- * Used for Measuring Noise in Areas such as, Environment, Mechanical Applications, Car Industry and much more
- * Helps in Differentiating Between Normal Noise Influences, and Excessive Noise, Nuisances e.g. in a Production Hall
- * Including Data Interface RS-232 * Delivered in a Robust Carrying Case
- * Multi Measuring Functions :
 - Lp : Standard Sound Level Measuring Function
 - Leq : Energy Equivalent Sound Level Measuring Mode (Type A)
 - Ln : Shows the Deviation From a Pre-defined Limit in %
- * Selectable Methods of Evaluation :
 - A : as Sensitive as the Human Ear
 - C : Sensitive for Noisier Environmental Conditions, Where there are Machines, Plant, Motors Etc.
 - F : for Areas with Constant Sound Intensity
- * Limit Value Function : Programmable Target Value for Go/no-go Test Values
- * Track Function for Continuous Recording of Changing Environmental Conditions
- * Peak Hold Mode to Capture Peaks
- * Internal Memory for Measured Values, for 30 Measurements. Can be Displayed on the PC

Specifications & Ordering Information <L1>

Spec.	Model	SU130		
Type		Lp A	Lp C	Lp F
Measuring range (dB)		30-130	35-130	35-130
Precision		3% of max		
Readout (dB)		0.1		
Battery Operation		Batteries Standard 4 × 1.5 V AAA		
Dimensions (w × d × h)		236 × 63 × 26 mm		
Net Weight Approx.		170 g		
Standard Package		Meter / Battery / Manual / Foam Cover / Carry Case		
Cat. No. & Price ₩		SA.SU130		₩ 193,500 / Set
Option ; SA.ATC.01	Data Transfer Software, Interface Cable Included	₩ 169,070 / Ea		
SA.ASU.01	Adjustment Device for Regular Adjustment of the Sound Level Meter	₩ 488,390 / Ea		
SA.ASU.02	Form Windshield	₩ 9,420 / Ea		

※ Hammacher® Premium Maintenance Service for Diamond Coating, Sharpening, Refinishing & c.
⇒ See the “Forceps” Section.

Hammacher® Premium Cement Spatula, Wironit™ & Rustproof Stainless-steel, L155~185mm, *Medicaluse approved* **NEW**
With Single- & Double-Ended, <Germany-made>, 프리미엄 시멘트 스패츨러, 연고칼, 독일제 의료용, 비부식

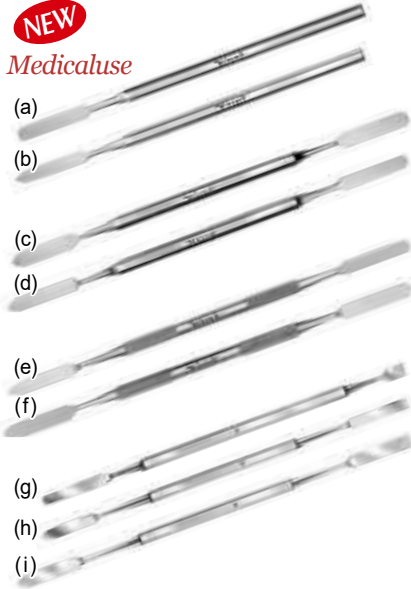

- Germany-made 프리미엄급, 의료용 스패츨러/연고칼, Wironit™ 특수스텐 & Rustproof 스텐제품
 - 약액 또는 시멘트를 혼합하거나 크라운, 인레이 등을 접착할 때 등 여러 용도로 사용
 - (1)~(3); Wironit™ Special Stainless-steel of 18/10 Cr-Ni; Non-magnetic, Rust-free, Anti-Acid / Chemicals / Heat
 - (4); Rustproof Stainless-steel of 18/8 Chrome-Nickel; Rust-proof, Anti-Acid / Chemicals / Heat
- * Used to Mix and Load Cement and Other Materials into Crowns or Inlay/Onlay Preparations.

		<M1>	
		Ea.	Price, ₩
(1) Single-Ended Wironit™ Special SS, with Octagonal-handle, 비자성 특수스텐			
HA.HWH218.00	(a) Cement Spatulas, SS, L155mm, 1 Blade-6×33mm, Stem - ϕ5.5mm		37,970
HA.HWH217.00	(b) , L158mm, 1 Blade-6×33mm, Stem - ϕ5.5mm		37,970
(2) Double-Ended Wironit™ Special SS, with Octagonal-handle, 비자성 특수스텐			
HA.HWH227.00	(c) Cement Spatulas, SS, L182mm, 2 Blade-5×35mm, Stem - ϕ4.5mm	Ea.	41,980
HA.HWH226.00	(d) , 2 Blade-6×35mm, Stem - ϕ4.5mm	Price, ₩	41,980
(3) Double-Ended Wironit™ Special SS, with Round-handle, 비자성 특수스텐			
HA.HWH237.00	(e) Cement Spatulas, SS, L182mm, 2 Blade-5×32mm, Stem - ϕ4.5mm	Ea.	44,730
HA.HWH239.00	(f) , L185mm, 2 Blade-7×37mm, Stem - ϕ4.5mm	Price, ₩	44,730
(4) Double-Ended Rustproof SS, with Octagonal-handle, 비부식 스텐			
HA.HSH096.00	(g) Cement Spatula, SS, L175mm, 2 Blade-5×30 & 8×10mm, Stem - ϕ5.5mm	Ea.	29,690
HA.HSH098.00	(h) , L178mm, 2 Blade-4×30mm, Stem - ϕ4.5mm	Price, ₩	29,820
HA.HSH101.00	(i) , L182mm, 2 Blade-6×35mm, Stem - ϕ4.5mm	Ea.	31,530

Hammacher® Premium Mixing Spatula, L165~415mm, *Medicaluse approved*

Ideal for Mixing Plaster & Alginates, Stainless-steel · PTFE-Coated, High-Polished, <Germany-made>, 프리미엄 믹싱 스패츨러, 연고칼, 독일제, 비부식

- Germany-made 프리미엄급; 비부식, 고강도, 고경도, 내약품성
- (1)&(3); Surgical Stainless-steel 420: Rust-proof, High-Strength/Hardness, Chemical Resistance
- (2); Teflon PTFE: Anti-Acid · Alkally · Chemicals · Corrosion, MP 260℃

		<L1>	
		Ea.	Price, ₩
(1) Rustproof SS Spatula, with Wood Handle, Non-Autoclavable, L165~415mm			
HA.HSN210.07	Mixing Spatula, Stainless-steel, L165, Blade -14×75mm		8,780
HA.HSN211.10	, L190, -18×100mm		8,930
HA.HSN212.13	, L230, -20×130mm		9,250
HA.HSN213.15	, L250, -22×150mm		9,710
HA.HSN214.20	, L310, -32×200mm		13,230
HA.HSN215.25	, L365, -38×250mm		15,540
HA.HSN216.30	, L415, -42×300mm		18,000
(2) PTFE-coated Spatula, with Wood Handle, Non-Autoclavable, L190/230mm			
HA.HSN211.10T	PTFE-coated Mixing Spatula, L190, Blade -18×100mm	Ea.	26,460
HA.HSN212.13T	, L230, -20×130mm	Price, ₩	27,520
(3) Medicaluse All Rustproof SS Spatula, Autoclavable, L230mm, 의료용 NEW			
		<M1>	
		Ea.	Price, ₩
HA.HSN218.13	Mixing Spatulas, Stainless-steel, L230, Blade -20×130mm		17,840

Hammacher® Premium Glass Spatula, L100mm **NEW**

For Mixing · Ceramic Work, <Germany-made>, 프리미엄 글라스 스패츨러, 독일제

		<L1>	
		Ea.	Price, ₩
HA.HSH563.00	Spatula, Glass, L100, Blade-2×7mm		2,490

Hammacher® Premium Glass Mixing Slab, 95×70×h6mm **NEW**

For Mixing Paste Materials, <Germany-made>, 프리미엄 글라스 믹싱 슬래브, 독일제

		<L1>	
		Ea.	Price, ₩
		* Polished-glass Mixing Pads with Beveled Edges	
HA.HSL751.00	Glass Mixing Slab, 95×70×h6mm		6,320

Articles	Cat. No	Description
----------	---------	-------------

KDY 산업용 스텐 헤라, Putty Knife, Stainless-steel, for Industry

다국적

경화형 (1) Stability-type, 견고형



- 견고한 PVC 손잡이, Stainless-steel Blade
- 다가네 타입으로 스크래퍼 성능 강화
- 페인트, 장판, 바닥, 벽지, 광고 전단지 이물질 제거 작업등
- 스테인리스 규격; Blade Width(Inch)

<B3>

ORDER NO.	MODEL NO.	PRICE, ₩ Ea.	규격	포장단위 Ea. / Pk.
① 0444-100	KHR-114	1,380	1-1/4"	1 / 12
② 0444-101	KHR-02	1,670	2"	1 / 12
③ 0444-102	KHR-03	1,960	3"	1 / 12
④ 0444-103	KHR-04	2,270	4"	1 / 12
⑤ 0444-104	KHR-05	2,750	5"	1 / 6
⑥ 0444-105	KHR-06	3,140	6"	1 / 6

유연형 (2) Flexibility-type, 유연형



- 견고한 PVC 손잡이, Stainless-steel Blade
- 유연형으로 이물질 제거작업에 용이
- 페인트, 장판, 바닥 등에 사용
- 스테인리스 규격; Blade Width(Inch)

ORDER NO.	MODEL NO.	PRICE, ₩ Ea.	규격	포장단위 Ea. / Pk.
① 0469-280	KHR-02F	1,150	2"	1 / 12
② 0469-281	KHR-03F	1,480	3"	1 / 12
③ 0469-282	KHR-04F	1,830	4"	1 / 12
④ 0469-283	KHR-05F	2,120	5"	1 / 6
⑤ 0469-284	KHR-06F	2,170	6"	1 / 6

, Silicone 실리콘 스페츨러 & Ladels 스테인리스 국자

실리콘 스페츨러/스크래퍼, Silicone Spatula

CHINA



- Silicone Blade
- Bamboo Handle

<B3>

ORDER NO.	규격	PRICE, ₩ Ea.	규격(mm)		포장단위 Ea. / Pk.
			가로	세로	
0462-931	소		30		1 / 10
0468-731	중	1,520	40	280	1 / 10
0468-732	대		45		1 / 10



Bochem® Short Wire-handle Portioning Ladle, High Grade Stianless-steel, 125~500ml NEW
Non-magnetic/Rust-free, High-Polished, <Germany-made>, 스텐 정량 분배 주걱/국자, 비자성/비부식

- 스푼 타입처럼 짧은 손잡이로 이루어져 있어 안정감 있게 사용이 가능하며, 일정한 양을 분배하는데 적합
- * 18/10 Stainless-steel; Non-magnetic, Rust-free, Anti-Acid / Chemicals / Heat
- * Suitable for Consistent Portioning Liquids * Volume(ml) indication Reached with Filling until Rim

<L1>

BC.3805	Ladle, w/Wire Handle, Stainless-steel, 125ml, Bowl ϕ 86×Handle 125mm	102,760
BC.3806	, 250ml, Bowl ϕ 105×Handle 145mm	117,390
BC.3807	, 500ml, Bowl ϕ 130×Handle 165mm	124,770

Ea.	Price, ₩
	102,760
	117,390
	124,770

EMCLAB® Visible Spectrophotometer “EMC-11S-V”, Standard 4-Cell Holder, 325~1000 nm NEW

With Color TFT Screen, EASY UV Basic PC Software, EMCLAB Works Certificate, <Germany-made>, 가시광 분광광도계



Visible 325~1000nm

- Tested with DAKKS (German Body of Accreditation) Certified UV/VIS Reference Materials NIST Traceable.
- Supplied with EMCLAB Works Calibration Certificate.
- Single Beam and 4nm Spectral Bandwidth.
- Standard 4-position Cell Holder (10×10 mm)
- Included 4×Glass Cells (10×10 mm) Basically
- * Color TFT Screen
- * Self-check system
- * Fast Choose Wavelength
- * Auto Setting Wavelength
- * Auto Zero and Blank
- * Sample Compartment for Different Cell Holders
- * Including EASY UV Basic PC Software (Quantitative, Kinetics, Photometry measurement)
- * Including EMCLAB Works Calibration Certificate.
- * Optional EASY UV PC Software (Quantitative, Kinetics, Wavelength Scan, Multi-wavelength, DNA/ Protein, Energy Scan)
- * IQ/OQ/PQ Documentation available



4-Cell Holder (Included)



1-position Cell Holder



2-position Solid Cell Holder

Spec.	Model	EMC-11S-V
Wavelength Range		325 ~ 1000nm
Spectral Bandwidth		4nm
Optical System		Single Beam, grating 1200 lines/mm
Wavelength Accuracy		±2nm
Wavelength Repeatability		1nm
Photometric Accuracy		≤ ±0.5 % T or ±0.004A@1A
Photometric Range		0-200 % T, -0.3 ~ 3A, 0 ~ 1999 Conc.
Photometric Repeatability		≤0.2 % T
Photometric Mode		T, A, C, F
Stray Light		0.2 % T
Stability		±0.004A/h@500nm
Baseline Flatness		±0.001A (200~1000nm)
Noise		0.003A@500nm
Detector		Silicone Photodiode
Display		Color TFT Screen
Central Beam Height		15mm
Standard Cell Holder		4-position Cell Holder 10×10mm
Light Source		Tungsten Lamp
Output		USB port & Parallel port for Printer
Power Requirement		AC 85~265V, 50/60Hz
Dimensions		L440×W350×H200 mm
Weight		8kg

Ordering information

<L1>

Cat. No.	Description	Ea. Price, ₩
EM.11SV	VIS Spectrophotometer EMC-11S-V, 325~1000nm	3,568,790

※ **Complete Set** : Spectrophotometer Main Unit, Power Cable, Dust Cover, 4×Glass Cells 10×10 mm, CD(User's Manual, Basic Software and Manual), USB Cable, Microfibre Cloth, Calibration Certificate.

Optional & Spare Accessories

Cat. No.	Description	Ea. Price, ₩
EM.00020	Option ; 4-position cell holder for cells, 10×10 mm, without slider	338,120
EM.00021	, up to 50 mm, without slider	408,550
EM.00019	, up to 100 mm, without slider	441,410
EM.00023	; 1-position cell holder for cells, 10×10 mm	244,200
EM.00045	, up to 100 mm	385,080
EM.00099	; 1-position holder for solid samples, up to 2-5 mm thickness	417,940
EM.00101	; 2-position holder for solid samples, up to 2-5 mm thickness	732,550
EM.00124	; EASY UV PC Software with Dongle Analyst	2,291,550
EM.00011	Spare ; Halogen(Tungsten) Lamp 6V 10W for EMC-11S	70,230

EMCLAB® UV/VIS Spectrophotometer "EMC-11S-UV", with Basic/Professional Software Sets, 200~1000 nm **NEW**
 With Standard 4-Cell Holder, EMCLAB Works Certificate, Tungsten & Deuterium Lamp, <Germany-made>, 자외선/가시광 분광광도계



UV/Visible 200~1000nm

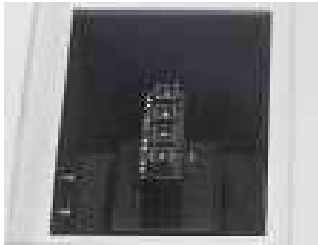

4-Cell Holder (Included)



1-position Cell Holder



2-position Solid Cell Holder



Spare Halogen Lamp

- Supplied with EMCLAB Works Calibration Certificate.
- Tested with DAKs (German Body of Accreditation) Certified UV/VIS Reference Materials NIST Traceable. ■ Single Beam and 4nm Spectral Bandwidth.
- Tungsten Lamp & Deuterium Lamp can be turned on/off Individually
- Included 4× Glass & 2× Quartz Glass Cells (10×10 mm) Basically.

- * Color TFT Screen * Self-check System * Fast Choose Wavelength
- * Auto Setting Wavelength * Auto Zero and Blank * Sample Compartment for Different Cell Holders
- * Can Display total 50 groups of Data, 3 groups per Screen. Can Display Standard Curve and the Curve Equation.
- * Data can be restored after a sudden Power Cut.
- * Tungsten lamp & Deuterium lamp can be turned On/Off Individually.
- * Including EMCLAB Works Calibration Certificate * IQ/OQ/PQ Documentation available

EMC-11S-UV with EASY UV Basic PC Software (Cat. No. EM.11SUV)

- * Inclusive EASY UV Basic PC Software following Functions.

Quantitative, Kinetics, Photometry Measurement (Absorbance and Transmittance).

EMC-11S-UV with EASY UV PC Software (Cat. No. EM.11SUVPC)

- * Inclusive EASY UV PC Software following Functions.

Quantitative, Kinetics, Spectrum Scan, Multi-wavelength, DNA/Protein Analysis, Energy Scan

Spec.	Model	EMC-11S-UV
Wavelength Range		200 ~ 1000nm
Spectral Bandwidth		4nm
Optical System		Single Beam, grating 1200 lines/mm
Wavelength Accuracy		±2nm
Wavelength Repeatability		1nm
Photometric Accuracy		≤ ±0.5 % T or ±0.005A@1A
Photometric Range		0-200 % T, -0.3 ~ 3A, 0 ~ 1999 Conc.
Photometric Repeatability		≤ 0.2 % T
Photometric Mode		T, A, C, F
Stray Light		0.2 % T
Stability		± 0.004A/h@500nm
Baseline Flatness		± 0.001A (200~1000nm)
Noise		0.003A@500nm
Detector		Silicone Photodiode
Display		Color TFT Screen
Central Beam Height		15mm
Standard Cell Holder		4-position Cell Holder 10×10mm
Light Source		Tungsten & Deuterium Lamp
Output		USB port & Parallel port for Printer
Power Requirement		AC 85~265V, 50/60Hz
Dimensions		L440×W350×H200 mm
Weight		9kg

Ordering information

<L1>

Cat. No.	Description	Ea. Price, ₩
EM.11SUV	UV/VIS Spectrophotometer EMC-11S-UV, 200~1000nm w/Basic Software	6,081,040
EM.11SUVPC	UV/VIS Spectrophotometer EMC-11S-UV, 200~1000nm w/EASY UV Software	8,372,580

- * **Complete Set** : Spectrophotometer Main Unit, Power Cable, Dust Cover, 4 × Glass & 2 × Quartz Cells 10 × 10 mm, CD(User's Manual), USB Cable, Microfibre Cloth, Calibration Certificate.

Optional & Spare Accessories

Cat. No.	Description	Ea. Price, ₩
EM.00020	Option ; 4-position cell holder for cells, 10 × 10 mm, without slider	338,120
EM.00021	, up to 50 mm, without slider	408,550
EM.00019	, up to 100 mm, without slider	441,410
EM.00023	; 1-position cell holder for cells, 10 × 10 mm	244,200
EM.00045	, up to 100 mm	385,080
EM.00099	; 1-position holder for solid samples, up to 2-5 mm thickness	417,940
EM.00101	; 2-position holder for solid samples, up to 2-5 mm thickness	732,550
EM.00124	; EASY UV PC Software with Dongle Analyst	2,291,550
EM.00011	Spare ; Halogen(Tungsten) Lamp 6V 10W for EMC-11S	70,230
EM.00130	; UV Deuterium Lamp for EMC-11S-UV	1,122,300

EMCLAB® High Accuracy UV/VIS Spectrophotometer "EMC-18S-UV", with Basic/Professional Software Sets NEW

With Standard 4-Cell Holder, 4 × Glass/2 × Quartz Cells, 190~1100nm, <Germany-made>, 고정밀 자외선/가시광 분광광도계



UV/Visible 190~1100nm

- Individual All-rounder for Routine and Special Analysis
- Tested with DAkks (German Body of Accreditation) Certified UV/VIS Reference Materials NIST Traceable. ■ Supplied with EMCLAB Works Calibration Certificate.
- Tungsten Lamp & Deuterium Lamp can be turned On/Off Individually to extend Lifetime.
- Single Beam and 2nm Spectral Bandwidth.
- Included 4 × Glass & 2 × Quartz Glass Cells (10 × 10 mm) Basically.

- * Color TFT Screen * Self-check System * Auto Setting Wavelength * Auto Zero and Blank
- * Save the Test Results. Total 200 Groups of Data and 200 Standard Curve. Convenient for check and reload.
- * Large Sample Compartment can be accommodate 5-100 mm Path Length Cuvettes with Optional Holders.
- * IQ/OQ/PQ Documentation available

EMC-18S-UV with EASY UV Basic PC Software (Cat. No. EM.18SUV)

- * Inclusive EASY UV Basic PC Software following Functions
- Quantitative, Kinetics, Photometry Measurement (Absorbance and Transmittance).**

EMC-18S-UV with EASY UV PC Software (Cat. No. EM.18SUVPC)

- * Inclusive EASY UV PC Software following Functions.
- Quantitative, Kinetics, Spectrum Scan, Multi-wavelength, DNA/Protein Analysis, Energy Scan.**



4-Cell Holder (Included)



1-position Cell Holder



8-position Auto Cell Changer



Spare UV Deuterium Lamp

Spec.	Model	EMC-18S-UV
Wavelength Range		190 ~ 1100nm
Spectral Bandwidth		2nm
Optical System		Single Beam, grating 1200 lines/mm
Wavelength Accuracy		±0.5nm
Wavelength Repeatability		0.3nm
Photometric Accuracy		≤ ±0.5 % T or ±±0.005A@1A
Photometric Range		0-200 % T, -0.3 ~ 3A, 0 ~ 9999 Conc.
Photometric Repeatability		≤ 0.2 % T
Photometric Mode		T, A, C, F
Stray Light		0.5 % T
Stability		±0.001A/h@500nm
Baseline Flatness		±0.001A (200~1000nm)
Noise		0.003A@500nm
Detector		Silicone Photodiode
Display		TFT Color Screen
Central Beam Height		15mm
Standard Cell Holder		4-position Cell Holder 10 × 10mm
Light Source		Tungsten & Deuterium Lamp
Output		USB port & Parallel port for Printer
Power Requirement		AC 110/220V, 50/60Hz
Dimensions		L490 × W380 × H220 mm
Weight		11kg

Ordering information

<L1>

Cat. No.	Description	Ea. Price, ₩
EM.18SUV	UV/VIS Spectrophotometer EMC-18S-UV, 190~1100nm w/Basic Software	13,383,110
EM.18SUVPC	UV/VIS Spectrophotometer EMC-18S-UV, 190~1100nm w/EASY UV Software	15,369,120

※ **Complete Set** : Spectrophotometer Main Unit, Power Cable, Dust Cover, 4 × Glass & 2 × Quartz Glass Cells 10 × 10 mm, CD(User's Manual), USB Cable, Microfibre Cloth, Calibration Certificate.

Optional & Spare Accessories

Cat. No.	Description	Ea. Price, ₩
EM.00020	Option ; 4-position cell holder for cells, 10 × 10 mm, without slider	338,120
EM.00021	, up to 50 mm, without slider	408,550
EM.00019	, up to 100 mm, without slider	441,410
EM.00023	; 1-position cell holder for cells, 10 × 10 mm	244,200
EM.00024	; 1-position cell holder water-jacketed for cells 10 × 10 mm	582,310
EM.00025	; 4-position cell holder water-jacketed for cells 10 × 10 mm, w/o slider	878,130
EM.00029	; 8-position Auto Cell Changer for cells 10 × 10 mm	1,877,150
EM.00045	; 1-position cell holder for cells up to 100 mm	385,080
EM.00099	; 1-position holder for solid samples up to 2-5 mm thickness	417,940
EM.00101	; 2-position holder for solid samples up to 2-5 mm thickness	732,550
EM.00124	; EASY UV PC Software with Dongle Analyst	2,291,550
EM.00012	Spare ; Halogen(Tungsten) Lamp 12V 20W for EMC-18S-UV	128,450
EM.00039	; UV Deuterium Lamp	1,122,300

EMCLAB® Double Beam UV/VIS Spectrophotometer "EMC-61PC-UV", with ANALYST PC Software **NEW**

With 2 × Single Cell Holder, 190~1100nm, <Germany-made>, 더블빔 자외선/가시광 분광광도계



Double Beam UV/VIS Spectrophotometer



Spare Halogen Lamp



Spare UV Deuterium Lamp

- The 2 Detectors measure Sample and Reference Respectively and Simultaneous for Optimizing Measurement Accuracy.
 - Provide Excellent Performance for Measurements in the Range of 190 to 1100 nm.
 - Suitable for Pharmaceutical, Biochemical and Clinical Lab Applications
 - The ANALYST PC Software based on Windows® makes the Instruments Versatile.
- * Double Beam * LCD Screen (320 × 240) * Self-check System
 * Sealed, Solvent-resistant tactile Keypad with Alpha-numeric Entry for File names and Units.
 * Pre-aligned Deuterium Lamp for Easy Lamp Replacement.
 * Data Download-to-PC Software expands the Data Storage to unlimited.
 * Data can be saved by USB memory directly.
 * Inclusive ANALYST PC Software (Quantitative Analysis, Kinetics, Wavelength Scan, Multi-wavelength and DNA/Protein Analysis)
 * Inclusive EMCLAB Works Calibration Certificate. * IQ/OQ/PQ Document available.

Spec.	Model	EMC-61PC-UV
Wavelength Range		190~1100nm
Spectral Bandwidth		1.8nm
Optical System		Double Beam, grating 1200 lines/mm
Wavelength Accuracy		± 0.3nm
Wavelength Repeatability		0.2nm
Photometric Accuracy		≤ ± 0.5 % T or ± 0.005A@1A
Photometric Range		0-200 % T, -0.3 ~ 3A
Photometric Repeatability		≤ 0.001A (0~0.5A), ≤ 0.002A(0~0.5A), ≤ 0.15 % T (0~100%)
Scan Speed		Hi, MED, LOW, MAX. 3000mm/min
Stray Light		0.05 % T
Stability		± 0.001A/h@500nm
Baseline Flatness		± 0.001A (200~1000nm)
Noise		0.0003A@500nm
Detector		Silicone Photodiode
Display		LCD 320 × 240
Central Beam Height		15mm
Standard Cell Holder		2 × Single Cell Holder 10 × 10mm
Light Source		Tungsten & Deuterium Lamp
Output		USB port A for USB memory stick USB port B for PC connectivity Parallel port for Printer
Power Requirement		AC 110/220V, 50/60Hz
Dimensions		L589 × W428 × H240 mm
Weight		22kg

Ordering information

<L1>

Cat. No.	Description	Ea. Price, ₩
EM.61PCUV	Double Beam UV/VIS Spectrophotometer EMC-61PC-UV, 190~1100nm	21,241,310

※ **Complete Set** : Spectrophotometer Main Unit, Power Cable, Dust Cover, 4 × Glass & 2 × Quartz Glass Cells 10 × 10mm, USB Memory (User's manual, ANALYST PC Software), USB Cable, Microfibre Cloth, Dongle Analyst, Calibration certification.



NEW

(1) Frosted-type 700 μ l Individually Packed in Hinged Case



(2) Black-type 700 μ l Individually Packed in Hinged Case

Micro Absorption Quartz Cell, with PTFE Lid, Inside Width 2mm, 700 μ l **NEW**
 Transmission Range 190~2500nm, Light Pass 10mm, 2-Side Polished, 마이크로 흡광 셀, 2면 투명

- 재질(Material) : ES(ExtraSil) Synthetic Quartz Glass
 - 투과 범위(Transmission Range) : 190 ~ 2500nm
 - 매우 적은 양의 샘플로도 측정 가능(동일한 Light Path 표준셀 용량의 20%임)
 - 외부 사이즈는 표준셀과 동일하나 소량의 양(700 μ l)으로 측정 가능
 - 샘플 주입구 부분은 샘플 손실을 최소화하기 위해 반구형으로 제작됨
- * ES Quartz Glass : 1) Transmission Values on Empty Cells : at 200nm approx. 80%
 2) Deviations in a Matched Set : at 200nm max. 0.5%
- * Optimal UV Transmission Performance, and Visible and Near Infrared Spectral Performance
- * Packed in Hinged Case
- * Suitable for Use with All Standard Cell Holder
- * 10mm Path Length Rectangular Cells
- * Quartz Cell has Extremely Low Thermal Expansion Coefficient, High Temperature Resistance
- * Excellent Chemical Stability and Electrical Insulation
- * Low and Stable Ultrasonic Delay Performance

(1) with Frosted Side Wall and Base

<L1>

Cat. No	Window Material	Light Path (mm)	Outside Dim. h×w×d (mm)	Inside Width (mm)	Base Thick (mm)	Volume (μ l)	Cover	Cs.	Price, ₩
DH.Cel1551	ES Quartz	10	45×12.5×12.5	2	3.2	700	PTFE-Lid	1ea	58,570

(2) with Black Side Wall and Base

Cat. No	Window Material	Light Path (mm)	Outside Dim. h×w×d (mm)	Inside Width (mm)	Base Thick (mm)	Volume (μ l)	Cover	Cs.	Price, ₩
DH.Cel1552	ES Quartz	10	45×12.5×12.5	2	3.2	700	PTFE-Lid	1ea	63,430



NEW

(1) Frosted-type 1400 μ l Individually Packed in Hinged Case



(2) Black-type 1400 μ l Individually Packed in Hinged Case

Semi-micro Absorption Quartz Cell, with PTFE Lid, Inside Width 4mm, 1400 μ l **NEW**
 Transmission Range 190~2500nm, Light Pass 10mm, 2-Side Polished, 세미 마이크로 흡광 셀, 2면 투명

- 재질(Material) : ES(ExtraSil) Synthetic Quartz Glass
 - 투과 범위(Transmission Range) : 190 ~ 2500nm
 - 적은 양의 샘플로도 측정 가능(동일한 Light Path 표준셀 용량의 40%임)
 - 외부 사이즈는 표준셀과 동일하나 소량의 양(1400 μ l)으로 측정 가능
 - 샘플 주입구 부분은 샘플 손실을 최소화하기 위해 반구형으로 제작됨
- * ES Quartz Glass : 1) Transmission Values on Empty Cells : at 200nm approx. 80%
 2) Deviations in a Matched Set : at 200nm max. 0.5%
- * Optimal UV Transmission Performance, and Visible and Near Infrared Spectral Performance
- * Packed in Hinged Case
- * Suitable for Use with All Standard Cell Holder
- * 10mm Path Length Rectangular Cells
- * Quartz Cell has Extremely Low Thermal Expansion Coefficient, High Temperature Resistance
- * Excellent Chemical Stability and Electrical Insulation
- * Low and Stable Ultrasonic Delay Performance

(1) with Frosted Side Wall and Base

<L1>

Cat. No	Window Material	Light Path (mm)	Outside Dim. h×w×d (mm)	Inside Width (mm)	Base Thick (mm)	Volume (μ l)	Cover	Cs.	Price, ₩
DH.Cel1522	ES Quartz	10	45×12.5×12.5	4	2	1400	PTFE-Lid	1ea	68,320

(2) with Black Side Wall and Base

Cat. No	Window Material	Light Path (mm)	Outside Dim. h×w×d (mm)	Inside Width (mm)	Base Thick (mm)	Volume (μ l)	Cover	Cs.	Price, ₩
DH.Cel1521	ES Quartz	10	45×12.5×12.5	4	2	1400	PTFE-Lid	1ea	83,330

Articles

Cat. No

Description



(1) Lid-type (2) Stopper-type
Macro Absorption Cell, 3.5ml

Absorption Macro Quartz Cell, with PTFE Lid or Stopper, 2-Side Polished, 3.5ml NEW
Transmission Range 190~2500nm, Light Pass 10mm, 흡광 마크로 셀, 2면 투명

■ 재질(Material) : ES(ExtraSil) Synthetic Quartz Glass

■ 투과 범위(Transmission Range) : 190 ~ 2500nm

* ES Quartz Glass : 1) Transmission Values on Empty Cells : at 200nm approx. 80%
2) Deviations in a Matched Set : at 200nm max. 0.5%

* Optimal UV Transmission Performance, and Visible and Near Infrared Spectral Performance * Packed in Hinged Case

* Suitable for Use with All Standard Cell Holder

* 10mm Path Length Rectangular Cells

* Quartz Cell has Extremely Low Thermal Expansion Coefficient, High Temperature Resistance

* Excellent Chemical Stability and Electrical Insulation

* Low and Stable Ultrasonic Delay Performance



(1) (2)
Individually Packed in Hinged Case

(1) Absorption Macro Cell, with PTFE Lid

<L1>

Cat. No	Window Material	Light Path (mm)	Outside Dim. h×w×d (mm)	Window Thickness (mm)	Volume (μl)	Cover	Cs.	Price, ₩
DH.Cel1501	ES Quartz	10	45×12.5×12.5	1.25mm×2	3500	PTFE-Lid	1ea	42,220

(2) Absorption Macro Cell, with PTFE Stopper

* Ideal for Volatile Liquid

Cat. No	Window Material	Light Path (mm)	Outside Dim. h×w×d (mm)	Window Thickness (mm)	Volume (μl)	Cover	Cs.	Price, ₩
DH.Cel1511	ES Quartz	10	45×12.5×12.5	1.25mm×2	3500	PTFE-Stopper	1ea	97,360



(1) Lid-type (2) Stopper-type
Macro Fluorescence Cell, 3.5ml

Fluorescence Macro Quartz Cell, with PTFE Lid or Stopper, 4-Side Polished, 3.5ml NEW
Transmission Range 190~2500nm, Light Pass 10mm, 형광 마크로 셀, 4면 투명

■ 재질(Material) : ES(ExtraSil) Synthetic Quartz Glass

■ 투과 범위(Transmission Range) : 190~2500nm

■ 광택 처리된 4면의 Window와 바닥

* ES Quartz Glass : 1) Transmission Values on Empty Cells : at 200nm approx. 80%
2) Deviations in a Matched Set : at 200nm max. 0.5%

* Optimal UV Transmission Performance, and Visible and Near Infrared Spectral Performance * Packed in Hinged Case

* Suitable for Use with All Standard Cell Holder

* 10mm Path Length Rectangular Cells

* Quartz Cell has Extremely Low Thermal Expansion Coefficient, High Temperature Resistance

* Excellent Chemical Stability and Electrical Insulation

* Low and Stable Ultrasonic Delay Performance



(1) (2)
Individually Packed in Hinged Case

(1) Fluorescence Macro Cell, with PTFE Lid

<L1>

Cat. No	Window Material	Light Path (mm)	Outside Dim. h×w×d (mm)	Window Thickness (mm)	Volume (μl)	Cover	Cs.	Price, ₩
DH.Cel1531	ES Quartz	10	45×12.5×12.5	1.25mm×2	3500	PTFE-Lid	1ea	123,320

(2) Fluorescence Macro Cell, with PTFE Stopper

* Ideal for Volatile Liquid

Cat. No	Window Material	Light Path (mm)	Outside Dim. h×w×d (mm)	Window Thickness (mm)	Volume (μl)	Cover	Cs.	Price, ₩
DH.Cel1541	ES Quartz	10	45×12.5×12.5	1.25mm×2	3500	PTFE-Stopper	1ea	194,670

EMCLAB® UV/VIS Calibration Filter Set with Works Calibration Certificate NEW!

- Made in Germany
- Use for UV/VIS Calibration Filter Set with EMCLAB Works Calibration Certificate for Maintenance and Service.

The EMC-SET-100 for testing the wavelength accuracy and photometric accuracy enable the user to check their measurement results. The EMC-SET-100 is supplied with EMCLAB Works Calibration Certificate of Secondary Spectrometric Calibration Standards.

UV/VIS Reference Materials for Testing :

- Wavelength Accuracy
- Photometric Accuracy



<L1>

Cat. No	Filter	Wavelength (nm)	Pk.	Price, ₩
EM.SET100	Holmium Oxide glass filter H1	W*: 279, 361, 453, 536, 638nm		2,385,010
	Neutral density glass filter N2, 0.25 Abs.	A*: 440, 465, 546.1, 590, 635nm		
	Neutral density glass filter N3, 0.5 Abs.	A*: 440, 465, 546.1, 590, 635nm		
	Neutral density glass filter N4, 1.0 Abs	A*: 440, 465, 546.1, 590, 635nm		
	Empty filter mount N0	-		

*A = Wavelength for Absorbance
 *W = Wavelength for Wavelength Accuracy

Articles	Cat. No	Description
----------	---------	-------------



73-holes PP Assembly Deluxe Rotary Pipet Stand, Autoclavable, Easy Cleaning NEW
 With 2-Layer Rotary Plate, Assembly, 125/140°C, PP 조립식 대용량 피펫 스탠드, 73-홀, 회전형

■ **Made of Polypropylene(PP), -10°C+125/140°C, Autoclavable**

- * This Accommodates 28 Pipettes with Diameters not Exceeding 11mm, Plus 45 Pipettes with Diameters not Exceeding 14mm.
- * Dimension : ϕ 230 mm \times h450 mm, 300g * Upper / Lower Integral Prevents Damage to the Rotary Type of Pipet
- * 73 Holes-size(4-Lines) : ϕ 11 mm \times 28Holes(1Line \times 11Holes, 2Line \times 17Holes)
 ϕ 14 mm \times 45Holes(3Line \times 21Holes, 4Line \times 24Holes)
- * Pipet Stand Main Support & Drain Receiving Level of the External Leak off Through the Pipet

SL.Sta3010 Pipet Stand, PP, 73-Places, ϕ 230 \times h450mm, Blue
SL.Sta3012 , Gray

<L1>	
Set.	Price, ₩
	7,410
	7,410

, Supporting Frames & Devices 조립식 프레임과 커넥터



Bochem® 3-way Lab-frame Foot, Tempered Cast Iron, ϕ 80 \times h41mm, for Lab-Frames NEW
 Suitable for ϕ 12mm Pipe & Rod, <Germany-made>, 프레임 다리(뚝)

- ϕ 12mm의 규격 Pipe/Rod용에 적합, Frame 하부 고정용 다리로 3개의 Pipe/Rod를 동시에 연결 가능
- * Assembly Lab Frame Foot of ϕ 12mm Pipe or Rod * Can connect Max. 3Rods at once

BC.5060 Holder Lab-frame Foot, ϕ 80 \times h41mm, Grip Capa. ϕ 12mm, 430g

<L1>	
Ea.	Price, ₩
	36,110

DAIHAN® 25 & 40 Lit Premium Programmable Bench-top Front Door Steam Sterilizer “MaXterile™ BT”, *Medicaluse* **NEW**
 With Auto-Front Door, Pre- & Post-Vacuum System, Class-B Sterilization, Auto-Microprocessor Control, and Dual Door Lock, 110°C ~ 135°C
 SQUARE Chamber Autoclave, 2 Perforated Stainless-steel Tray, HEPA Filter, Max 2.30 bar, 사각철판 벤치탑 고압 스팀 멸균기

NEW

110~135°C
 0.4 ~ 2.3 bar

Medicaluse



2-Year Warranty

25 & 40 Lit Bench-top Steam Sterilizer
 “MaXterile™ BT”

MODE	Temperature (°C)	Pressure (bar)	Sterilizing Time (min)	Drying Time (min)
Unwrapped 1	121	1.1	20	30
Unwrapped 2	134	2.1	5	30
Wrapped 1	121	1.1	30	30
Wrapped 2	134	2.1	15	30
Liquid	121	1.1	20	0
Bowie Dick	134	2.1	4	5
User Program	110 - 135	0.4 - 2.3	4 - 30	0 - 60

Program Cycle



Square Inner Chamber



Sliding Perforated Shelf



(1) SS Wire Tray



(2) SS Removable Rack



(3) HEPA Filter-kit, 0.3µm



(6) Thermal Printer



(5) Movable Stand

- Made in Korea ■ PL(Product Liability)
- 치과, 병원, 생명공학용에 적합한 멸균기
- with Certificate & Traceability : Controlled by Serial Number, Certificate, Delivery-information, and Traceable Data Base System.
- Class-B Sterilization Cycle by EN13060-2 Standard : Pre Vacuum Air Removal → Water Filling → Heating → Sterilizing → Ventilation → Post Vacuum Drying → End
- SS Square Chamber for Corrosion Resistance and Maximum Working Space
- * Ideal for Dental Clinic, Hospital, Biotechnology, etc.
- * Full Automatic Process Cycle by High-performance Microprocessor Controller
- * Built-in Separate Water Reservoir Supplies Water Automatically
- * Self-diagnostic and Safety System :
 - Display Error Codes and Audible Alarm
 - Over Pressure Release Valve
 - Automatic and Manual Door Lock System
 - Over Temp Protector with Thermostat
- * Intuitive User Interface(LCD) & Indicator of Working(LED Lamp)

Specifications & Ordering information

<M2>

Spec.	Model	“MaXterile™ BT25”	“MaXterile™ BT40”
Capacity		25 Lit	40 Lit
Water Filling Tank		5 Lit (Reservoir)	
Sterilizing Cycle-type		Class-B Cycle by EN13060-2 Standard	
Temp Range		110°C~135°C	
Pressure & Gauge		0.4 ~ 2.3 bar, Built-in Analog & Digital Pressure Gauge	
Timer & Alarm		Error Status & Timer-end	
Controller		Microprocessor PID Control System(Fully Automatic) with LCD Monitor	
Programmable Function		Pre-set 6 Programs (Customizable 5- & Fixed Bowie Dick 1- Program)	
Door Lock		Automatic Wheel Inter Locking with One Touch Sliding Handle	
Air Filtration System		Built-in HEPA Filter, 0.3µm Particle Removal 99.97%	
Vacuum Pump		Built-in Vacuum Pump(33LPM, 580mmHg) for Pre-vacuum & Post-vacuum Drying	
Air Removal-type		Vacuum	
Tray (Included)		2 Stainless-steel Perforated Tray	
Safety Circuit		Over-Temp / -Pressure / -Current protection, Sensor Error Detection	
Printer		Thermal printer with 1 Record Paper Roll: w58 × φ40mm 1000 Sterilization Cycle Data / roll (Date, Temperature, Pressure, Time, Error Status, etc.)	
Material		Interior : Stainless-steel 304 Polished, Exterior : Epoxy Powder Coated Steel	
Dimension (w×d×h) & Weight	Interior	270×420×h230mm	300×480×h300mm
	Exterior	495×689×h460mm, 60kg	527×787×h530mm, 70kg
	Packing	580×750×h580mm, 75kg	650×820×h740mm, 85kg
Power Consumption		2.5kW	
Electric Reqt.		110 V, 60 Hz or 220 V, 50 / 60 Hz, 1 Phase	
Cat. No.	220V	DH.SteB8001	DH.SteB8002
	110V	DH.SteB8011	DH.SteB8012
Price, Each. ₩		4,269,000	4,879,000

* Other Specifications are available upon Customer's Request.

※ 운임 착불

Spare Accessory

Part No.	Description	Ea. Price, ₩
DH.SteBA1013	(1) SS Wire Tray, 260×370mm, for “MaXterile BT25”	126,000
DH.SteBA1017	, 273×410mm, for “MaXterile BT40”	141,000
DH.SteBA1011	(2) SS Removable Rack, 260×385×h155mm, for “MaXterile BT25”	146,000
DH.SteBA1016	, 290×425×h185mm, for “MaXterile BT40”	160,000
DH.SteA1015	(3) Replacement HEPA Filter-kit, 0.3µm	27,100

Optional Accessory

Part No.	Description	Ea. Price, ₩
DH.SteBA1010	(4) SS Perforated Tray, 255×365×h25mm, for “MaXterile BT25”	102,000
DH.SteBA1015	, 285×405×h30mm, for “MaXterile BT40”	113,000
DH.SteBA1026	(5) Movable Stand with 1 Drawer, 580×700×h850mm	320,000
DH.SteA1005	(6) Thermal Printer, Paper Roll, “STEA1005”	349,000
DH.SteA1006	Thermal Paper Package, 4 Paper Roll, for “STEA1005”	12,100

Bench-top Autoclave with Validation (IQ, OQ) Service

Part No.	Description	Ea. Price, ₩
DH.SteB5025	Validation Service(IQ, OQ), with “MaXterile BT25”	
DH.SteB5040	, with “MaXterile BT40”	

Articles	Cat. No	Description
----------	---------	-------------

DAIHAN® 17 · 32 · 50Lit Dry Heat Sterilizer “SteD”, with Fast Cooling System, Thermal Printer, Forced Air, Up to 250°C, *Medicaluse*
 Ideal for Dental Clinic, Hospital, Biotechnology, Fast Sterilization Time(3min at 190°C & 1hr at 160°C), **건열 멸균기**



Medicaluse

2-Year Warranty

B. “SteD-30” & C. “SteD-50” Model

※ A. “SteD-17” is under Development and the Shape is subject to Change.

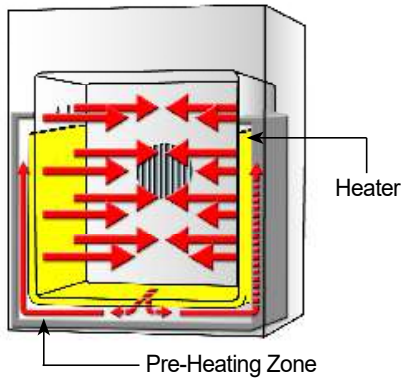

3-Side Heating Zone Forced-air Mechanism



(1) SS Wire Shelf (Included)

- **Made in Korea** ■ **PL(Product Liability) Insurance**
- **치과, 병원, 생명공학용에 적합한 멸균기**
- **with Certificate & Traceability : Controlled by Serial Number, Certificate, Delivery-information, and Traceable Data Base System.**
- **Optimized Air Flow by Forced-air Mechanism**
- **3-Side Heating Zone : The Best Temp Uniformity & Accuracy by High Performance Heating Mechanism**
- **Fast Cooling System : Powerful Cooling Fan ensures only 50min Cooling Time (Down to 50°C)**
- * Digital PID Control System Implementing Superior Temperature Accuracy
- * Patented Jog-Dial & Push Button Control System
- * Space Saving Compact Size
- * Efficient Square Inner Chamber
- * Alarm Function : Error Status and Timer-end

Specifications & Ordering information

<M1>

Spec.	Model	Coming Soon	A. “SteD-17”	B. “SteD-30”	C. “SteD-50”
Capacity			17 Lit	32 Lit	50 Lit
Heater Power			1,400 W		
Sterilization Modes			① Custom Setting Mode ② 3min at 190°C ③ 1hr at 160°C		
Temp	Range		Room Temp +5°C to 250°C		
	Fluctuation		±1.0°C at 37°C, ±1.5°C at 160°C & 190°C		
	Variation		±1.0°C at 37°C, ±3.0°C at 160°C, ±5.0°C at 190°C		
	Sensor		PT100		
Cooling Time			Approx. 50min Down to 50°C		
Temp Resolution			± 0.1°C		
Circulation			Forced-air Type		
Controller			Digital PID Control by Advanced Microprocessor Jog-Dial with Push Button		
Display			Digital LCD with Back Light		
Timer			99hr 59min (Delay / Continuous Function)		
Printer			Thermal printer with 1 Record Paper Roll: w58×φ40mm 1000 Sterilization Cycle Data / roll (Date, Temperature, Time, Error Status, etc.)		
Material	Internal		Stainless-steel (#304)		
	External		Powder Coated Steel		
	Insulation		Glass Wool		
Shelf (Included)			2 Stainless-steel Wire Shelf Load per Shelf : 16kg		
Safety Device			Over Temp and Over Current Protector Sensor Error Detector		
Dimension (w×d×h)	Interior		312×190×h300mm	310×290×h360mm	370×345×h420mm
	Exterior		458×377×h564mm	458×595×h664mm	518×647×h724mm
	Packing		550×470×h650mm	562×702×h747mm	622×754×h807mm
Net Weight			30kg	36kg	44kg
Shipping Weight			38kg	43kg	59kg
Power Consumption			1.5 Kw		
Electric Reqs.			230V, 50/60 Hz		

Cat. No.	DH.SteD0002	DH.SteD0003	DH.SteD0005
Price, Each. ₩	-	2,102,000	2,215,000

* Other Specifications are available upon Customer's Request.

※ **운임 착불**

Spare Stainless-steel Wire Shelf

DH.WIG12032 (1) Wire Shelf, 280×260mm, for 32 Lit, **“IGSN032”**
DH.WON11050 , 340×310mm, for 50 Lit, **“ONS050”**

Ea. Price, ₩
26,000
32,000

Dry Heat Sterilizer with Validation (IQ,OQ) Service

SL.SteD5003 Validation Service(IQ, OQ), with **“SteD-30”**
SL.SteD5005 , with **“SteD-50”**

Ea. Price, ₩

medicin® 14Lit Low Temp Plasma Sterilizer, "STERLINK® Plus", Direct-Injection Pouch Sterilization, Medicaluse NEW

Max 57°C, 7-min, 58% H₂O₂ Injection, Ideal for Medical Instrument, with ITS™ Real-Time Monitoring System

소형 저온 플라즈마 멸균기, 의료용, 빠른 멸균(Min. 7min), 직분사 파우치 사용 시 멸균 6개월 유지



Medicaluse



1-Year Warranty

14Lit STERLINK® Plus, FDA 승인완료



* 챔버 대각선 길이 : 470mm

* Barcord 실시간 모니터링 시스템(ITS™)으로 관리



STERPACK® 멸균팩 2종 with "Barcord"



(3) STERLOAD® 멸균제 카트리지



(4) Label Printer(외장형) with Cable



(5) Label Sticker Roll

- Made in Korea ■ 1-Year Warranty
- The First Non-US Plasma Sterilizer Clearance by US "FDA"
- Certification : CE, GMP, Health Canada, ISO13485, TGA(Therapeutic Goods Administration)
- 광범위한 의료 기구들을 멸균하기 위한 최적의 멸균기
- 열과 습기에 약한 의료 기구 멸균 기능
- 멸균상태를 즉시 판단할 수 있는 진공된 파우치 (6개월 멸균효과 유지)
- 파우치 모드 - 세계 최초 직분사 파우치 방식의 특허받은 빠른 7분 멸균 기술
- 멸균팩 바코드를 활용한 "실시간 모니터링 시스템(ITS™)" 으로 멸균유지/멸균기 상태확인
- Ideal for Low Temperature Plasma Sterilizer to Inactivate Microorganisms for a Broad range of Metal and Nonmetal Medical Devices and Surgical Instruments at Low Temperature.
- Can be Sterilize Medical Devices by Diffusing Hydrogen Peroxide Vapor into the Chamber or Pouch and It Rapidly Sterilizes Medical Instruments and Materials without Leaving Toxic Residues.

- * 7-min Fast Sterilization with Direct Injection Pouch and Patented Sterilization Technology. (Only for 1Lit)
- * It does not Damage Compatible Instruments which are Sensitive to "Heat" and "Moisture"
- * Vacuum Sealing Pouches enable to have an Immediate Check on the Sterile Condition.
- * Double Cycle Sterilization Process is applied complying with "ISO 14937".
- * Decomposing residual "H₂O₂" into "WATER" and "OXYGENE" quipped with "O₃" Purifying Filter
- * Improved Sterile Reliability with "HEPA Filter" easily Replaceable
- * Processing for Sterilizing :
Put the Product in the Pouch → Direct Sterilize "H₂O₂" → Check the Vacuum Pouch.

STERLINK® Plus 제품사양

모델	멸균 공정	멸균 시간	용량	멸균제
STERLINK® Plus	Pouch Mode	(1) STERPACK® : 7min	1Lit	H ₂ O ₂ 58%~59.5% (0.1 cc/cell)
	Pouch Plus Mode	(2) STERPACK® Plus : 14min	4Lit	H ₂ O ₂ 58%~59.5% (0.3 cc/cell)
	Chamber Mode	(3) STERLOAD® : 36min	14Lit	H ₂ O ₂ 58%~59.5% (0.9 cc/cell)

* STERPACK®, STERPACK® Plus, STERLOAD®는 CE mark, Health Canada, TGA에서 국제인증받은 멸균제입니다. 단, 본 소모품은 식약처 인증을 받은 의료기기가 아닙니다.

Specifications & Ordering information

<M3>

Spec.	Model	STERLINK® Plus
Capacity		14Lit
Temperature		Less than 57°C
Class		Class IIb (Rule 15, Annex IX of MDD 93/42/EEC)
Vacuum Pump		Built-in Type
Material		Interior : Stainless-steel, Exterior : ABS
Dimension & Weight		W433 × D614 × H437mm 67kg
Chamber Dimension		W264 × D410 × H125mm
Power		1 kVA
Input		100-120 / 220-240 VAC, 50/60 Hz
Cat. No.		DH.SteP0014
Price, Each. ₩		9,000,000

Optional Accessory

		Pk.	Price, ₩
DH.StePA2001	(1) "STERPACK®" Sterilizer Pouch, Nylon / PP(Polypropylene) 1Lit, 135 × 280mm	50ea	47,600
DH.StePA2002	(2) "STERPACK®" Sterilizer Pouch, Nylon / PP(Polypropylene) 4Lit, 250 × 430mm	30ea	75,600
DH.StePA2003	(3) "STERLOAD®" Sterilizer Cartridge, 14Lit	30ea	75,600
DH.StePA2004	(4) Label Printer, W120 × D102 × H146mm / 0.5kg	1ea	420,000
DH.StePA2005	(5) Label Sticker, W52 × D110mm, 49 Sticker / Roll	4Roll	42,000

Articles	Cat. No	Description
----------	---------	-------------

DAIHAN Labtech® 56 & 130 Lit Low Temp Plasma Sterilizer “MaXterile™ PS60 & PS130”, Max. 60°C, **Medicaluse** NEW
 Suitable for Medical Instrument, 50% Hydrogen Peroxide Injection, Microprocessor Touch Screen Controller
 With Front Door & SQUARE Chamber, 2 Perforated Stainless-steel Tray, Emergency Stop Button(PS130), 저온 플라즈마 멸균기

NEW



(1) 2 SS Tray

2-Year Warranty

56Lit “MaXterile PS60”



(1) 2 SS Tray (Included)

2-Year Warranty

130Lit “MaXterile™ PS130”



(1) 50% H₂O₂ Bottle



(2) Air Filter-kit



(3) Movable Stand for “MaXterile PS60”



(4) (5) Indicator

- **Made in Korea** ■ **PL(Product Liability)**
- **수술용 내시경, 카테터, 모터가 있는 수술기구 등 고온, 증기, 압력에 취약한 의료기기의 멸균에 적합**
- **with Certificate & Traceability : Controlled by Serial Number, Certificate, Delivery-information, and Traceable Data Base System.**
- **Speedy Sterilization Time within 30-60min, Economical Cycle Cost**
- **Environment Friendly : H₂O₂ Decomposes to Oxygen and Vapor Water, Leaving No Residues**
- * Ideal for Sterilization of Medical Instruments that are Vulnerable to High Temp, Steam & Pressure such as Surgical Endoscopes, Catheter, Electric Surgical Instruments with Motor
- * Lumen Test Certification by EN13060 / EN867-5 : - Flexible Lumen : $\phi 1 \times 12,000\text{mm}$
 - Stainless-steel Lumen : $\phi 1 \times 1,000\text{mm}$ - Single through Lumen : $\phi 1 \times 1,500\text{mm}$
- * Special H₂O₂ Injection System
- * Self-diagnose and display Error Code ; Stops Operation and Vents in case of Any Malfunction
- * Economical because of Using General 50% Hydrogen Peroxide(H₂O₂)
- * Efficient in Using Space with Compact Size Body & Squared Inner Chamber
- * Processing for Perfect Sterilizing :
 - Pre-Chamber Cleaning : Pre-Vacuum → H₂O₂ Injection → Diffusion
 - Plasma Sterilization : Vacuum → Plasma Processing & Sterilization → H₂O₂ Injection → Diffusion
 - Post Chamber Cleaning : Vacuum → Plasma Processing → Venting
- * Built-in Thermal Printer

Specifications & Ordering information

<M3>

Spec.	Model	MaXterile™ PS60	MaXterile™ PS130
Capacity		56 Lit	130 Lit
Sterilization Temp		Max. 60°C	
Sterilization Agent		50% Hydrogen Peroxide	
Vacuum Capacity		400 Lit / min	25 m ³ / hr
Operating Modes		Quick / Standard / Intense / Vacuum Test	
Ambient Condition		Pressure : 700 ~ 1060 hPa, Temp : 10°C~40°C, Humidity : 30 ~ 75%	
Controller & Display		Microprocessor Touch Screen Controller (Temp, Timer, Program Cycle, Vacuum)	
		7" LCD	10.4" LCD
Door System		Push Interlocking	Automatic Interlocking
Tray (Included)		2 Stainless-steel Perforated Tray	
Safety Circuit		Over-Temp Protection, Current Leakage Breaker	
Printer		Thermal printer with 1 Record Paper Roll: w58 × ϕ 40mm 1000 Sterilization Cycle Data / roll (Date, Temperature, Time, Error Status, etc.)	
Material		Interior : Reinforced & Electro Polished 304, Exterior : Stainless-steel 304	
Dimension (w×d×h) & Weight	Interior	285×700×h285mm	454×707×h404mm
	Exterior	680×880×h890mm, 172kg	750×980×h1600mm, 350kg
	Packing	720×900×h930mm, 190kg	900×1150×h1800mm, 360kg
Power Consumption		3.0 kW	3.3 kW
Electric Reqts.		220 V, 50 / 60 Hz, 1 Phase	

Cat. No.	DH.SteP8001	DH.SteP8002
Price, Each. ₩	28,314,000	50,336,000

* Other Specifications are available upon Customer's Request.

※ **윤임 착불**

Spare Accessory

	Ea. Price, ₩
DH.StePA1001 SS Perforated Tray, 250×660mm for “MaXterile PS60”	233,000
DH.StePA1006 SS Perforated Tray, 435×650×h30mm for “MaXterile PS130”	291,000
DH.StePA1011 (1) Bottle with Hydrogen Peroxide(50%), 100ml	39,000
DH.StePA1012 Spare Bottle Only, $\phi 55 \times 124\text{mm}$	8,470
DH.SteA1006 Thermal Paper Package, 4 Paper Roll for Thermal Recorder	12,100
DH.SteA1016 (2) Replacement Air Filter-kit	44,000

Optional Accessory

	Ea. Price, ₩
DH.StePA1015 Oil Mist Trap for “MaXterile PS60”	199,000
DH.StePA1016 Oil Mist Trap for “MaXterile PS130”	1,956,000
DH.StePA1017 Oil for Vacuum Pump, 1Lit for “MaXterile PS60”	42,000
DH.StePA1018 Oil for Vacuum Pump, 1Lit for “MaXterile PS130”	63,000
DH.StePA1025 (3) Movable Stand with 1 Drawer, 680×865×h610mm	630,000
DH.StePA1030 (4) Biological Indicator, 100ea.	1,511,000
DH.StePA1031 (5) Chemical Indicator, 250sheet.	177,000

Stirrers, Accessories and Stirrer Bars

Articles

Cat. No

Description

Bochem® Stainless-steel Centrifugal-type Stirring Shaft, for Lab & Industrial Overhead Stirrers, Rod ϕ 8 & 10 × L400~650mm NEW
 Ideal for Low/Middle Viscosity, with 2 Flexible Blades, Non-magnetic/Rust-free, <Germany-made>, 스텐레스 교반봉 / 임펠러

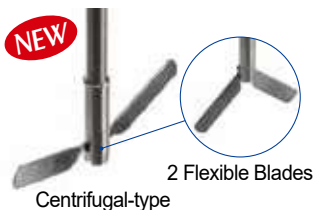

- 오버헤드 스티러용 임펠러, 교반원 심력에 의해 날개가 펼쳐짐
- Good Finished : Surface & Stirring Center
- Recommended to use with Flexible Coupling for Gentle Stirring & Safety Working

* 18/10 SS ; Non-magnetic, Rust-free, Anti-Acid / Chemicals / Heat

Cat. No	Stir-Shaft, SS, Rod-	Swingrotor-
BC.9210	ϕ 8 × L400mm	ϕ 90 × h10mm
BC.9211	ϕ 8 × L500mm	ϕ 90 × h10mm
BC.9213	ϕ 10 × L400mm	ϕ 90 × h10mm
BC.9214	ϕ 10 × L500mm	ϕ 90 × h10mm
BC.9215	ϕ 10 × L650mm	ϕ 90 × h10mm

Ea.	Price, ₩
	41,650
	43,530
	46,180
	49,470
	46,530

Bochem® Stainless-steel Square-type Stirring Shaft, with 6 × ϕ 12mm Hole, for Lab & Industrial Overhead Stirrers, Rod ϕ 8 & 10 × L400 & 500mm NEW
 Ideal for Low/Middle Viscosity, Non-magnetic/Rust-free, <Germany-made>, 스텐레스 교반봉 / 임펠러



- 오버헤드 스티러용 임펠러, 패들 헤드에 균일한 간격으로 구멍이 뚫려 있어 용해 및 혼합을 위한 적절한 난류를 형성
- Good Finished : Surface & Stirring Center
- Recommended to Use with a Flexible Coupling for Gentle Stirring & Safety Working

* 18/10 Stainless-steel; Non-magnetic, Rust-free, Anti-Acid / Chemicals / Heat

Cat. No	Stir-Shaft, SS, Rod-	Rotor-
BC.9504	ϕ 8 × L400mm	ϕ 70 × h65mm × t1.7mm, 6 × ϕ 12mm Hole
BC.9505	ϕ 8 × L500mm	ϕ 70 × h65mm × t1.7mm, 6 × ϕ 12mm Hole
BC.9507	ϕ 10 × L400mm	ϕ 70 × h65mm × t1.7mm, 6 × ϕ 12mm Hole
BC.9508	ϕ 10 × L500mm	ϕ 70 × h65mm × t1.7mm, 6 × ϕ 12mm Hole

Ea.	Price, ₩
	53,630
	55,730
	57,040
	60,800

Stirrer Bars

PTFE Plain- & Octagonal-type Mixed Stirrer Bar-Set, for Lab & Industry, L15~75mm, 18pcs/set NEW
 Excellent for Chemical and Corrosion Resistance, For Universal Application, -200°C + 260°C, PTFE 플레인형+옥타고날형 마그네틱바 세트



- Useful Assortment of the Most Popular Size of PTFE Magnetic Stirrer Bars
- * Sectional Utility Box, with Assembly Partition
- * Component : Plain-(ϕ 5 × L15mm) · (ϕ 7 × L20mm) · (ϕ 7 × L30mm) · (ϕ 8 × L50mm) × 2pcs, (ϕ 10 × L60mm) × 1pcs
- Octagonal-(ϕ 8 × L15mm) · (ϕ 8 × L25mm) · (ϕ 8 × L30mm) · (ϕ 8 × L40mm) × 2pcs, (ϕ 8 × L75mm) × 1pcs



SL.Sti4106	Set of 18 PTFE Plain- & Octagonal-type Mixed Stirrer Bars
B3.802	Spare Box, Divider & Hinged Locking Lid, 10-divid. type : 200 × 130 × h35mm

Set.	Price, ₩
18pcs	37,140
1ea	2,220

PTFE Oval- & Octagonal-type Mixed Stirrer Bar-Set, for Lab & Industry, L10~75mm, 18pcs/set NEW
 Excellent for Chemical and Corrosion Resistance, -200°C + 260°C, PTFE 타원/달걀형+옥타고날형 마그네틱바 세트



- Useful Assortment of the Most Popular Size of PTFE Magnetic Stirrer Bars
- * For Universal Application
- * Sectional Utility Box, with Assembly Partition
- * Component : Oval-(ϕ 5 × L10mm) · (ϕ 7 × L15mm) · (ϕ 15 × L35mm) · (ϕ 16 × L48mm) × 2pcs, (ϕ 25 × L70mm) × 1pcs
- Octagonal-(ϕ 8 × L15mm) · (ϕ 8 × L20mm) · (ϕ 8 × L30mm) · (ϕ 8 × L50mm) × 2pcs, (ϕ 8 × L75mm) × 1pcs



SL.Sti4107	Set of 18 PTFE Oval- & Octagonal-type Mixed Stirrer Bars
B3.802	Spare Box, Divider & Hinged Locking Lid, 10-divid. type : 200 × 130 × h35mm

Set.	Price, ₩
18pcs	44,510
1ea	2,220

Articles	Cat. No	Description
----------	---------	-------------

NEW



① Individual Package

② 100pads

MediTop® Disposable Ethanol Swab, for Skin Disinfection, 30×30 & 40×40mm, *Medicaluse* With 78.85% Ethyl Alcohol, 일회용 에탄올 스왐, 멸균/비멸균 소독솜 **NEW**

- **Made in Korea** ■ **Made of Rayon Staple Fiber**
- **Made of Rayon Staple Fiber Containing 78.85% Ethanol Alcohol**
- **Ideal for Disinfection of Wound & Medical Equipment**

* Easier and more Comfortable to Use for Disinfection * Easy to Carry * No Skin Irritation
* for External Use Only * Approx Size Swab : 30×30 & 40×40mm

(1) Sterile, 78.85% Ethanol Swab

DM.13.1003 ① Ethanol Swab, Sterile, **Individual Package**, 30×30mm
DM.13.1004 ② , **100pads/Package** , 40×40mm

Pk.	Price, ₩	Cs.	Price, ₩
100pads	2,240	60pk	
100pads	1,210	100pk	

<M3>

(2) Non-Sterile, 78.85% Ethanol Swab

DM.13.1005 ① Ethanol Swab, Non-Sterile, **Individual Package**, 30×30mm
DM.13.1006 ② , **100pads/Package** , 40×40mm
DM.13.1007 ③ , **200pads/Package** , 40×40mm

Pk.	Price, ₩	Cs.	Price, ₩
100pads	2,070	60pk	
100pads	1,040	100pk	
200pads	1,390	48pk	

NEW



Individual Package

MediTop® Disposable Isopropanol Swab, for Skin Disinfection, 30×30mm, *Medicaluse* **NEW With 70% Isopropyl Alcohol, Rayon Staple Fiber, 일회용 이소프로판올 스왐, 살균소독용**

- **Made in Korea** ■ **Made of Rayon Staple Fiber Containing 70% Isopropyl Alcohol**

* Ideal for Disinfection of Wound & Medical Equipment * Easier and more Comfortable to Use for Disinfection
* Easy to Carry * No Skin Irritation * for External Use Only
* Approx Size Swab : 30×30mm

DM.13.1008 Isopropanol Swab, 30×30mm, Individual Package

Pk.	Price, ₩	Cs.	Price, ₩
100pads	2,250	60pk	

<M3>

NEW



Sterile Cotton-tipped Swab, with White Flexible PP-Handle **NEW Ideal for Medical, Individual Sterile Package, Disposable, 멸균면봉**

* Long Paper handle : L100×φ4mm * Case : 2ea×30Pk (Individual Sterile Package)
* Single Cotton tip : L25×φ10mm

H13.SW01001 Swab, Sterile, 1×φ10mm Tips, L10cm PP-Handle

Pk.	Price, ₩
60ea	4,250

<M3>

NEW



Paper Handle Cotton-tipped Swab, Double-Ended, for Multi-use **NEW Ideal for Cleaning Mini-or Micro-Articles, 200pcs/Zipper bag, 종이 핸들 다용도면봉**

* One Spiral-Shaped Tip & One Spearhead Tip-type, 2 Side Cotton-Tips : φ5.3mm

DH.SW01024 Swab, Cotton, 2×φ5.3mm Tips, L78×φ2.4mm Paper Handle

Pk.	Price, ₩
200ea	2,360

<B2>



1~50ml Filtered Single-use Medical Syringe PP, with Filter Needle, Rubber Gasket, **Medicaluse**
With 5µm Membrane Filter Needle, Steriled, Individual Pack, PP 의료용 필터주사기 **NEW**

- Made in Korea
- 필터주사침과 일반주사침이 같이 들어있는 주사기, 약액을 흡입시 필터 주사침으로 이물질을 걸러내고 일반 주사침으로 주사한다.
- CE Certified ■ GMP(Good Manufacturing Practice) Certified ■ ISO9001 and ISO13485

* Application : Rubber Gasket on the Plunger, Ideal for Medical * Sterilized by E.O Gas

* Graduations PP-Barrel and PP-Plunger, Filter Needle & Needle Included, Sterile Individual Packaging

<M3>

DM.13.1024	Syringe, Filter Needle, Luer Tip, 1 / 0.01ml, 26G	Pk.	Price, ₩
DM.13.1025	, 3 / 0.1ml, 23G	100ea	28,320
DM.13.1026	, 5 / 0.2ml, 23G	100ea	28,320
DM.13.1027	, 10 / 1ml, 23G	100ea	31,460
DM.13.1028	, 20 / 1ml, 23G	50ea	15,730
DM.13.1029	, 30 / 1ml, 21G	50ea	17,310
DM.13.1030	, 50 / 1ml, 21G	25ea	8,660

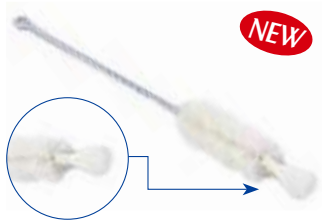

Laboran® Syringe Brush, Gentle Cleaning for Syringe, φ21~30mm **NEW**
Made of Steel Wire, with Horse Hair & Special Both Hair, L200~300mm, 시린지용 브러쉬

* Ideal for Cleaning Syringe

<L2>

SL.Bru3095	Syringe Brush, Bristle L125 × φ21, Total L200mm	Ea.	Price, ₩	Pk.	Price, ₩
SL.Bru3096	L150 × φ25, Total L260mm	2,590		11ea	26,350
SL.Bru3097	L165 × φ30, Total L300mm	3,560		11ea	36,220
		4,700		11ea	47,740



Single-Use Medical Needle, Stainless-steel, **Medicaluse** **NEW**
Steriled, Individual Pack, 21~27 Gauge, 일회용 멸균 주사침

- Made in Korea ■ CE Marked ■ GMP(Good Manufacturing Practice) Certified
- ISO9001 and ISO13485 * Sterilized by E.O Gas

<M3>

DM.13.1031	Needle, Tip φ0.81 × L32 mm, 21G, Green	Pk.	Price, ₩
DM.13.1032	, Tip φ0.71 × L32 mm, 22G, Black	100ea	2,680
DM.13.1033	, Tip φ0.64 × L25 mm, 23G, Blue	100ea	2,680
DM.13.1034	, Tip φ0.56 × L25 mm, 24G, Violet	100ea	2,680
DM.13.1035	, Tip φ0.51 × L25 mm, 25G, Orange	100ea	2,680
DM.13.1036	, Tip φ0.46 × L13 mm, 26G, Beige	100ea	2,680
DM.13.1037	, Tip φ0.41 × L13 mm, 27G, Gray	100ea	2,680



Intravascular Catheter, with Needles, Individual Sterile Package, **Medicaluse**, 혈관내투브, 카테터 **NEW**

- Made in Korea * Non-Toxic / -Pyrogenic, Radiopaque Teflon * Collecting Blood / Injecting Medicine

<M3>

DM.13.1038	Intravascular Catheter, Sterile, with 18 Gauge needle	Pk.	Price, ₩
DM.13.1039	, with 20 Gauge needle	50ea	16,210
DM.13.1040	, with 22 Gauge needle	50ea	16,210
DM.13.1041	, with 24 Gauge needle	50ea	14,480

Neo-Top™ Stationary Needle Smelter "HS-045", Dispose of Injection Needle Immediately after Use, Melting Needle into Powder **NEW**
 For Various Needle from 15~31 Gauge with Any Length, Process within 1sec, <Korea-made>, 주사바늘 처리기, 고정형

NEW



Stationary Needle Smelter



Insert a needle into the Needle Smelter



Needles melted into Powder within Second

- 주사바늘 찌림사고 예방 ■ 1초이내 소각처리 ■ 기술특허 제0296740호
- Semi-permanent Use ■ Small and Easy to Operate.
- Disposes Needle Completely by Melting into Powder with Heat of approx. 1,600 °C
- * Protects Operators from Secondary Infection ; Prevents Potential Needle Sticking Accidents.
- * Environmental Protection ; Powder after Disposal is Sterilized by High Heat.
- * Effective and Cost Efficient ; Consumes 1kW only to Process 5,000 Needles.

Specifications & Ordering information

<M4>

Spec.	Model	"HS-045"
Capacity		15 ~ 31 Gauge Needle
Disposal Time		100 Needle/min
Durability		Semi - permanent
Dimension & Weight		w 240×h 110×d 120 mm, 1.4 kg
Power		110 ~ 220V, 50 ~ 60Hz
Cat. No.		DM.13.1063
Price, Each. ₩		378,130



3M® “8067” Confidential Waterproof Tape, with General Purpose Acrylic Adhesive NEW
 Ideal for Building Walls or Gaps in Pipes, Applicable to Varying Temperatures, 방수 기밀 테이프, 사계절용

- 건물 외벽이나 배관의 틈새에 기밀 및 방수 용도로 사용되는 테이프
- 젖은 표면이나 콘크리트 벽체에도 사용 가능한 높은 접착력
- * Confidentiality and Waterproof Purposes on Building Exterior Walls or Gaps in Piping
- * The Special Acrylic Adhesive can be Applied from Low to High Temperatures.
- * High Adhesion for Wet Surfaces or Concrete Walls

<B4>

3M.08.1036 “8067” Confidential Waterproof Tape, 50mm × 22.8M
3M.08.1037 , 100mm × 22.8M

Pk.	Price, ₩
2roll	16,920
2roll	33,820



Magnet Tape with Dispenser, with Adhesive Side and Magnetic Side, w19mm × L3m NEW
 Easy and Quick Removal and Repositioning, 마그넷 테이프, 디스펜서형

- 자석 부착이 가능한 모든 곳에 사용가능(Multiuse) : 프리저(Freezer), 후드(Hood), 인큐베이터(Incubator), etc
- * Dispenser Size : 100 × 75mm * Tape : w19mm × L3m

<B1>

DH.Tap3011 Magnet Tape, with Dispenser, w19mm × L3m

Ea.	Price, ₩
	3,060



Waterproof Silicone Tape, Transparent, Multi-Purpose, w20mm × L3m NEW
 Ideal for Prevent Mildew, Durable, 60.2g, 실리콘 방수테이프

- 탁월한 방수효과로 곰팡이 방지, 어디든 간편하게 부착 가능
- 가스레인지, 벽 틈새, 세면대, 싱크대, 욕조, 등 사용 가능
- Ideal for Sealing Basin, Bathtub, Gas Stove, Kitchen Sink, Wall Edge
- * Long Lasting & Strong Adhesion * Easy to Remove with any Trace
- * Prevent Mildew * Easy to Use and Clean

<B1>

DH.Tap6001 Silicone Tape, Waterproof, w20mm × L3m

Ea.	Price, ₩
	2,300

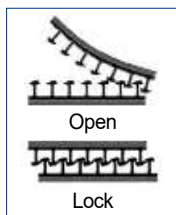

3M® “Dual-Lock” Reclosable Fasteners, with General Purpose Acrylic Adhesive NEW
 Ideal for Metal & Glass & Plastic, Temp, Moisture and UV Resistant, 듀얼락 탈부착식 “듀얼락”, 강력 양면용

- 암수 구분없는 스템들이 맞물리면서 기계적 결합 이상의 인장강도를 가짐
- 나사 볼트를 대체할 수준의 강도를 가진 탈착식 테이프
- 다양한 코팅표면 및 금속, 유리, 플라스틱에 우수한 접착력
- * Temperature, Moisture and UV Resistant * Helps Reduce Vibration
- * Pressure-sensitive Adhesive Easily Forms a Powerful Bond
- * Application and Maintenance Ease

<B4>

3M.SJ3550 Dual-Lock, Stem Density 250per sq/in, 25.4mm × 3M , Black, Using Temp up 93℃
3M.SJ3551 , Stem Density 400per sq/in, 25.4mm × 4.5M, Black, Using Temp up 93℃
3M.SJ3560 , Stem Density 250per sq/in, 25.4mm × 4.5M, Clear, Using Temp up 104℃

Pk.	Price, ₩
1roll	232,170
1roll	285,300
1roll	307,520

Articles	Cat. No	Description
----------	---------	-------------



3M® Scotch® “610” Cellophane Film Tape, with Pressure Sensitive Rubber Resin, Up to 140°C
 Ideal for High-Temperature Packaging, Adhesive to a Variety of Materials, **라이트 듀티 테이프**

- 미국 ASTM 규격의 도장 부착력 테스트 법에 가장 부합하는 도장 피막 검사용 테이프
- 고온 포장 용도로 사용하기 위해 고안된 투명 필름 테이프
- 페인트 공정, PCB 인쇄 공정에서 많이 사용
- 천연 고무 접착제는 높은 초기 접착 강도를 자랑하며 다양한 재료에 접착 가능
- * Dimensionally Stable on a Wide Variety of Applications Up to 300°F (140°C)
- * Controlled Consistent Unwind for Reliable Hand Dispensing.
- * Easily Dispensed. * Excellent holding properties.

3M.08.610 Cellophane Film Tape, 25mm×65.6M, Thick 0.058mm, Clear

Pk.	Price, ₩
1roll	19,180

<B4>

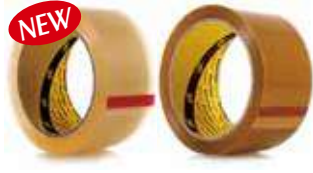

3M® Scotch® “372KS” Box Packing Tape, Transparent & Translucent Milky-Amber
 Ideal for High Strength Packaging, Solvent-type, Durable, w48×L50m, **박스포장용 테이프, 보급형**

- 초기 접착력 우수, 모서리 찢김 저항성
- Solvent-type Acrylic Adhesive Coated Tape
- * High Edge Tear and Split Resistance
- * Excellent Tensile Strength

3M.08.372KS.C “372KS” Box Tape, 48mm×L50m, Clear
3M.08.372KS.A , Milky-Amber

Pk.	Price, ₩	Cs.	Price, ₩
1roll	1,110	50pk	
1roll	1,110	50pk	

<B4>

포장테이프, 베이지 & 투명, OPP Packing Tape KOREA



- (1) 기본형; 베이지&투명
- 추위에서도 뛰어난 품질을 나타내어 저온 환경에서도 사용 가능

- (2) 냉동용; 베이지&투명
- 접착력이 강해 추위에 강하고 냉동 창고에서도 사용 가능
 - 식품 관련 업체 사용

(1) 러버 기본형 <B3>

ORDER NO.	폭(mm)	길이(M)	PRICE, ₩ Ea.	색상	재질	포장단위 Ea. / Cs.
0516-214	48	40	1,010	● 베이지	러버	1 / 50
0516-194	48	40	1,010	○ 투명	러버	1 / 50

(2) 저온 냉동용

ORDER NO.	폭(mm)	길이(M)	PRICE, ₩ Ea.	색상	포장단위 Ea. / Cs.
0516-663	48	40	1,010	● 베이지	1 / 50
0476-992	48	40	1,010	○ 투명	1 / 50

마스킹 테이프, Masking Tape, White, Multiuse KOREA



- 접착력이 우수하며 색상별로 선명도가 뛰어나 표지 구분, 각종 디자인, 데코레이션, 학습재료 등 다양하게 사용 가능

<B3>

ORDER NO.	폭(mm)	길이(M)	PRICE, ₩ Ea.	색상	포장단위 Ea. / Cs.
0476-968	12	40×2개	980		1 / 58
0516-206	25	40	980	○ 백색	1 / 56
0516-207	50	40	1,940		1 / 28

크라프트(종이) 테이프, Kraft Packing Tape KOREA



- 크라프트지(종이) 재질로 뒷면에 PE 라미네이팅 처리를 하여 접착 코팅한 테이프
- OPP 테이프에 비해 우수한 접착력과 찢김성이 우수함

<B3>

ORDER NO.	폭(mm)	길이(M)	PRICE, ₩ Ea.	포장단위 Ea. / Cs.
0483-846	50	40	1,620	1 / 50

취급주의용 테이프, “Handle-care” Packing Tape KOREA



- 냄새가 적고 잘 찢어지지 않음
- 뛰어난 접착력을 자랑하며 주의를 필요로 하는 상품을 포장시 편리함

<B3>

ORDER NO.	폭(mm)	길이(M)	PRICE, ₩ Ea.	포장단위 Ea. / Cs.
0477-000	48	40	1,110	1 / 50

Articles

Cat. No

Description

NEW



3M® “3381” Aluminum Foil Tape, High-strength & UV Resistance, 0.07mm Thickness, 48mm×45.7M
Coated with an Acrylic Pressure Sensitive Adhesive, 알루미늄 호일 테이프, 우수한 내습성 & 지속력 NEW

- 고내열도 ■ 우수한 UV 저항성 ■ 내습성 & 지속력 탁월 ■ 얇고 유연하여 곡선작업에 유리함
- Applications in Cold Weather Conditions and Excels in Humidity
- Ideal for Light Reflecting · Heat Shielding · Moisture Barrier · Thermal Conducting · Sealing · Splicing
- * Acrylic Adhesive Supplies Superior Temperature and UV Resistance for Durability
- * Performs and Serves as an Excellent Barrier against Factors such as Moisture, Dust and Flame
- * Malleable foil is conformable, capable of adhering to irregular surfaces
- * Easy-to-tear Design offers Simple Application

<B4>

Pk.	Price, ₩
1roll	7,730

3M.08.3381 “3381” Aluminum-foil Tape, 0.07mm Thickness, 48mm×45.7M, Thickness 0.07mm

NEW



알루미늄 테이프, 열전도 부위 보호용에 적합, Aluminium Foil Tape

KOREA

- 냉장고나 세탁기 등 냉각 및 보온성을 높이기 위해 콘덴서 코일을 고정, 열을 전도시키는 용도에 사용
- 일반 가정에서 싱크대 보수 및 열전도 부위 보호용 등 다양한 용도로 사용

<B3>

ORDER NO.	폭(mm)	길이(M)	PRICE, ₩ Ea.	색상	포장단위 Ea. / Cs.
0516-208	50	5	820	● 은색	1 / 50



다용도 면(천) 테이프, Multiuse Cloth Tape

KOREA

NEW



- 두께가 두꺼워서 파이프 등과 같은 소재의 표면보호에 적합
- 모든 박스종류의 포장 등 다양한 각도의 용도로 사용
- 손으로 쉽게 절단되어 작업이 용이

<B3>

ORDER NO.	폭(mm)	길이(M)	PRICE, ₩ Ea.	색상	포장단위 Ea. / Cs.
0516-199	48	15	1,570	● 녹색	1 / 40
0516-656		25	2,560		1 / 40

NEW



3M® “Scotch 23” Premium Rubber Insulating & Splicing Electrical Tape, Up to 69kVolts, 19mm×L9m
Made of Self-fusing Ethylene Propylene Rubber, 고압/69kv 프리미엄 전기절연 고무 테이프, 자기융착 NEW

- 고압(UP to 69kVolts)에 강한 고급 전기 절연 고무 테이프
- 접착제 없이도 강하게 붙는 자기융착 테이프로, 테이프끼리 겹쳐지도록 감아서 사용
- * Used for Low & High Voltage (Up to 69 kVolts) Applications
- * Made of Self-fusing Ethylene Propylene Rubber (EPR)
- * With “Snakeskin” Liner that is Easily Removed as the Tape is Applied.

<B4>

Pk.	Price, ₩
1roll	9,910

3M.08.1038 “Scotch 23” Electrical Tape, Insulating & Splicing, EPR, 19mm×L9m, Black

Articles	Cat. No	Description
		PTFE Seal Tape, good for Screw-thread Sealing, w13mm×L10m & 15m, 0.1mm Thick NEW Up to 290°C Heat Resisting, 0.48g/cm ³ Density, 스크류 실링용 테프론 테이프
	■ 스크류 체결 실링용에 적합 * Ideal for Screw-thread Sealing	
0412-608 Seal Tape, PTFE, w13mm×10m		Ea. Price, ₩ 240
0577-650 , w13mm×15m		Cs. Price, ₩ 100ea

3M® “361” Glass Cloth Tape, Silicone Adhesive, Clean Removal, -54°C +232°C, w50mm×L54.8m **NEW**
Ideal for High Temperature Performance, Strong Abrasion Resistant, Durable, 유리섬유 테이프

	<ul style="list-style-type: none"> 유리섬유 기재로 구성, 내열성이 우수하고 접착력이 강하며 깔끔하게 제거됨 용접 마스킹 및 고온 실링 등 다양한 고온 작업에 주로 사용됨 Can be Certified to Meet F.A.R. 25.853, Flame Resistant Specification
	* Withstand Temperatures Ranging from -54°C to 232°C (Up to 288°C or Higher) * Silicone Adhesive Provides Good Holding Power
	* Deal for Seaming and Sealing Panels, High Temperature Masking, Bundling, Holding and Harness Wrapping
	* Suitable for Aerospace, Automotive, Roofing, Specialty Vehicle and Ship Building Industries
3M.08.361 “361” Glass Cloth Tape, w50mm×L54.8m	Pk. Price, ₩ 79,550

 3색 식별 형광 테이프, 노랑/녹색/적색 KOREA
3-colored Fluor-Tape, Ideal for Identification



■ 야간에 불빛을 받아 밝은 빛의 광선을 반사해 안전의 경고나 비상구, 창문, 유리 등 필요한 부분에 대응도로 사용 가능

ORDER NO.	폭(mm)	길이(M)	PRICE, ₩ Ea.	색상	포장단위 Ea. / Cs.
▶ 0477-002				● 노랑	
0477-004	48	2	1,350	● 녹색	1 / 50
▶ 0477-003				● 적색	

 5색 바닥라인 마킹테이프, 5-colored Floor Masking Tape KOREA



5-color
Blue, Green, Red, White, Yellow

- 신축성이 뛰어나며 내구성이 강해 통행이 많은 곳에서도 쉽게 마모되지 않음
- 공장, 생산현장, 학교, 체육관, 헬스클럽, 운동 경기장에서 구획을 나누거나 정리정돈 및 주의 표시를 할 때 많이 사용

ORDER NO.	폭(mm)	길이(M)	PRICE, ₩ Ea.	색상	포장단위 Ea. / Cs.
0516-203	50	33	3,490	● 노랑	1 / 40
0516-200				● 적색	
0516-201				● 청색	
0516-202	50	33	3,490	● 녹색	1 / 40
0516-204				○ 백색	

 빛 반사 테이프, Reflective Tape, w50 & 100mm, L45.7m

- 각종 산업 현장, 공사 현장 등 안전 표시
- 빛 반사로 시인성 확보

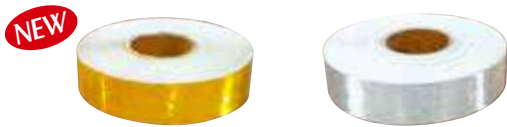

ORDER NO.	색상	PRICE, ₩	폭(mm)	길이(M)
0438-129	● 황색	18,630	50	45.7
0438-130		37,240	100	
0438-127	○ 백색	18,630	50	45.7
0438-128		37,240	100	

 접근금지 웨빙띠, PS Webbing, w48mm×L100m KOREA

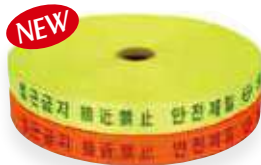

- 재질 : 폴리에스테르 Polyester Film
- 토목, 골조 공사 안전 구획, 고층부 안전통로 구획 접근 금지 방지책

ORDER NO.	품명	PRICE, ₩	색상	폭(mm)	길이(M)
0437-874	접근방지바	49,000	● 녹색(형광)	48	100
0437-875		49,000	● 주황색	48	

Articles

Cat. No

Description



Humidity Indicator Paper, for Humidity Detection, RH 10~60% NEW

Reaction Humidity:6-points, RoHs Supported, Reversibility, Blue→Pink, 수분 측정지

■ 습식 상태로 습도판정-수분이 많으면 청색에서 분홍색으로 변하여 표시되며 습도의 범위는 6단계로 세분화됨

* It can Determine Humidity of Color Over 12hours after Putting.

* Not Suitable for Place Where Humidity Change a lot at Short Time

* Accuracy : ±5%RH(at 25℃)

* Discoloration : Blue→Pink

* Dimensions : 1Sheet: L34×w121mm

* Package : 200 Sheets/Pk.

<L2>

SL.Lab9121 Humidity Indicator Paper, 10~60%RH, ±5%RH

Pk.	Price, ₩
200sheet	214,940

Articles	Cat. No	Description
----------	---------	-------------

DAIHAN® WBGT Checker, Temp. 0°C ~ 50°C · 0.1~99.9%RH · WBGT 0°C ~ 50°C, with Alarm Function, 70×60×h22 mm NEW
 Ideal for Outdoor & Indoor Heat Stress Measuring, 휴대용 WBGT 습구흑구 온열지수 측정기, 체감온도 측정, 열사병 예방용

NEW



Wearable Design

- **WBGT (Wet Bulb Globe Temperature) = 습구흑구 온열지수 : 건구온도 + 습구온도 + 흑구온도**
: 기온, 습도, 복사열, 기류 등을 종합적으로 분석해 열에 의해 인간이 받는 스트레스를 나타낸 수치.
- **휴대용, 착용 가능한 제품으로, 야외활동을 주로하는 운동선수나 군인, 산업현장에서의 사용에 유용.**
- * Simultaneously Display WBGT, Temperature & RH.
- * Programmable Buzzer and Red LED 4 level Danger Zone Warning
- * Audible Alarm Volume Adjustable (75 dB / 60 dB / mute)
- * Can be used the Tripod to Hold the Checker Vertically for Long Term use.



<L1>

WBGT	Flag	Activity Intensity
< 80°F < 26.7°C	White	Normal activity. Caution should be taken.
80-84.9°F 26.7-29.4°C	Green	Discretion is required in planning intense physical activity.
85-87.9°F 29.4-31°C	Yellow	Intense activity for beginners should be curtailed.
88-89.9°F 31-32.2°C	Red	Intense exercise must be curtailed Be on high alert.
> 90°F > 32.2°C	Black	Cancel all outdoor exercise.

Specifications & Ordering information

Spec.	Model	DH.The3021
Temp. & Humidity Range (Resolution)		0°C~50°C & 0.1~99.9% RH (0.1°C & 0.1% RH)
Temp. & Humidity Accuracy		±0.6°C & ±5%RH (at 25°C, 10~90%RH); others : ±7%RH
Globe Temp. & Black Ball Size		0°C~70°C & Dia. 40mm
WBGT Temp. & Alarm Range		0°C~50°C & 20°C~50°C
Dimensions & Weight		70×60×h22mm (LCD Size : 40×39mm) & 90g
Standard Package		Meter, 2×AAA Battery, Manual, Paper Box, Arm Strap
Cat. No. & Price ₩		DH.The3021 ₩ 69,140 / Set

DAIHAN® Professional WBGT Monitor, Temp. 0°C ~ 50°C · 0.1~99.9%RH · WBGT 0°C ~ 50°C, with Alarm Function, 302×75×h36.7mm NEW
 Ideal for Outdoor & Indoor Heat Stress Measuring, with Backlight Indicator, 전문가용 WBGT 습구흑구 온열지수 측정기, 열사병 예방용

NEW



Pull up to Protect Sensor
Design Patent Pending

- **WBGT (Wet Bulb Globe Temperature) = 습구흑구 온열지수 : 건구온도 + 습구온도 + 흑구온도**
: 기온, 습도, 복사열, 기류 등을 종합적으로 분석해 열에 의해 인간이 받는 스트레스를 나타낸 수치.
- **야외활동에서 고온에 대한 적절한 노출 수준 결정을 도와줌 (열사병 예방)**
- **혹서의 작업환경이나 산업현장에서의 안전관리 목적으로 사용하기에 적합함.**
- * Back Light Indicator Function (Green, Yellow, Red, Flashing red) as WBGT Condition Reminder.
- * Easy-to-read Big LCD Display, 6 Dust Proof Rubber Keys.
- * One Button Switch to Check Air / Globe temperature & In/Out WBGT.
- * Designed with Capacitance Type Humidity Sensor to get Accurate and Quick Reading.
- * Hold Function to Freeze Reading and Max/Min Function Included
- * Temperature unit °C/°F Switchable



Can be used with Tripod

<L1>

Specifications & Ordering information

WBGT indicator	87785 / 87782	WBGT indicator	87785 / 87782
Green backlight (26.7-29.4°C)		Red backlight (31-32.2°C)	
Yellow backlight (29.4-31°C)		Red flashing backlight (Above 32.2°C)	

Indicator Display

Spec.	Model	DH.The3023
Temp. & Humidity Range(Resolution)		0°C~50°C & 0.1~99.9% RH (0.1°C & 0.1% RH)
Temp. & Humidity Accuracy		±0.6°C & ±3%RH (at 25°C, 10~90%RH); others ±5%RH
Globe Temp.(Inside Black Ball)		0°C~80°C
Globe Temp. Acc.(Indoor & Outdoor)		±1°C at 15°C~40°C, others ±1.5°C & ±1.5°C at 15°C~40°C, others ±2°C
WBGT Temp. & Alarm Range		0°C~50°C & 20°C~50°C
Dimensions & Weight		302×75×h36.7mm (LCD Size : 50×32mm) & 300g, Black Ball : Dia.75×h75mm
Standard Package		Meter, 4×AAA Battery, Manual, Paper Box
Cat. No. & Price ₩		DH.The3023 ₩ 241,780 / Set

DAIHAN® Single Use Cold Chain Temperature Datalogger, with PDF Report, Waterproof (IP65), -30°C + 70°C **NEW**

Auto-Generate a PDF & Excel Report, Programmable by Users, 일회용 콜드체인 온도 Data 로거



- 온도 값을 측정하고 기록하여 사용자의 필요에 따라 Excel 또는 PDF 형식으로 보고서 생성이 가능함.
 - Temperature Values can be Measured and Recorded to Generate Reports in Excel or PDF Format by the User.
 - USB-type Product : Can be Used by Simply Connecting to a PC without Having to Install any Software.
- * IP65 waterproof bag could provide the moisture barrier properties of data logger.

Specifications & Ordering information

<L1>

Spec.	Model	DH.The3035
Measure Range (Resolution) & Accuracy		-30°C + 70°C, -22°F + 158°F (0.1°C, 0.1°F) & ±0.5°C
Sampling Point & Interval		8,192 readings & 30 seconds, 5, 10, 30, 60, 90, 120 minutes
Dimensions & Weight		80 × 43 × 2.5mm, 105 × 55 × 2.5 mm(with Bag) & 10g
Standard Package & Battery		Logger, Manual, Paper Box, 1 × 3.0V CR2032 Battery
Cat. No. & Price ₩	DH.The3035	₩ 32,810 / Ea

DAIHAN® Temperature USB 2.0 Datalogger, with PDF Report, Waterproof (IP67), -30°C + 70°C **NEW**

Auto-Generate a PDF & Excel Report, Programmable by Users, USB Type 온도 Data 로거



- 온도 값을 측정하고 기록하여 사용자의 필요에 따라 Excel 또는 PDF 형식으로 보고서 생성이 가능함.
 - USB형식의 제품으로 별도의 소프트웨어 설치 필요없이 PC에 연결만 하면 사용할 수 있음.
 - Temperature Values can be Measured and Recorded to Generate Reports in Excel or PDF Format by the User.
 - USB-type Product : Can be Used by Simply Connecting to a PC without Having to Install any Software.
- * Automatically Generate a PDF and Excel Report while Plugged into a Computer.

Specifications & Ordering information

<L1>

Spec.	Model	DH.The3031
Measure Range (Resolution) & Accuracy		-30°C + 70°C, -22°F + 158°F (0.1°C, 0.1°F) & ±0.5°C
Sampling Point & Interval		48,000 readings & 30 seconds, 5, 10, 30, 60, 90, 120 minutes
Dimensions & Weight		110 × 45 × h17mm & 50g
Standard Package & Battery		Logger, Manual, Paper Box, 2 × 3.0V CR2032 Battery
Cat. No. & Price ₩	DH.The3031	₩ 104,360 / Ea

DAIHAN® Bluetooth 4.0 Wireless Temperature Monitoring Datalogger, Waterproof (IP67), -30°C + 70°C **NEW**

With Free Application for Smart Devices, Bluetooth Type 온도 Data 로거



- 온도 값을 측정하고 기록하여 Application을 통해 사용자가 실시간으로 데이터 확인 및 보고서 생성이 가능함.
 - Users can Check the Temperature Change in Real-time through the Application "Nice Logger" Downloaded in the App Store.
- * Report Contains Data Summary, Graph and Detailed Data. * Big LCD Provides Real-time Data Every 5 seconds.

Specifications & Ordering information

<L1>

Spec.	Model	DH.The3033
Measure Range (Resolution) & Accuracy		-30°C + 70°C, -22°F + 158°F (0.1°C, 0.1°F) & ±0.5°C
Sampling Point & Interval		48,000 readings & 10 seconds to 120 minutes
Dimensions & Weight		70 × 50 × h23mm & 70g
Standard Package & Battery		Logger, Manual, Paper Box, 1 × 3.0V CR2 Battery
Cat. No. & Price ₩	DH.The3033	₩ 116,660 / Ea

Articles	Cat. No	Description
----------	---------	-------------

DAIHAN® Non-Contact Precision IR Thermometer, with OLED Display, Ergonomic Hand Grip NEW
 2× Measuring Mode ; Clinical-mode(32.0℃~43.0℃/±0.2℃), Object-mode(0℃~100℃/±0.2℃), 비접촉식 적외선 저온정밀 온도계

2× Temperature Measuring Mode :

- Clinical-mode (32.0℃~43.0℃ / ±0.2℃)
- Object-mode (0℃~100℃ / ±0.2℃)



Non-Contact Precision IR Thermometer with OLED Display

- Made in Korea ■ PL(Product Liability) Insurance
- with Certificate & Traceability : Controlled by Serial Number, Certificate, Delivery-information, and Traceable Data Base System
- Personal type Compact Ultra Low Temperature Freezer
- 위생적인 비접촉식 측정 방식, 0.5초의 빠른 응답속도
- Non-contact Temperature Checker Designed for 34.0℃~42.6℃, 0℃~100.0℃
- Ideal for Checking Body Heat, Bath Water, Milk Temperature and Other Object.
- 다양한 온도 측정이 가능한 2종류의 측정 모드
- 2×Measuring Mode : (1) Clinical-mode : Ideal for Body Heat, 34.0℃~42.6℃/ ±0.2℃
 (2) Object-mode : Ideal for Various Object, 0℃~100.0℃/ ±0.3℃
- * High-quality OLED Display * Ergonomic Hand Grip
- * Fast Response Time : 500ms * Temperature Units are °F, °C(Factory Default : °C)

Specifications & Ordering information <M1>

Spec.	Model	DH.The01
Measuring Range	Clinical-mode	34.0℃~42.6℃
	Object-mode	0℃~100.0℃
Resolution & Temp Accuracy	Clinical-mode	0.1℃ & ±0.2℃
	Object-mode	0.1℃ & ±0.3℃
Targeting Distance		3~5cm
Battery		2×3V Battery(AAA)
Dimension & Weight(g)		45×53×h173mm (OLED Size : 33.4×h34mm) & 80g
Standard Package		Meter, Battery, Manual, Paper Box
Cat. No. & Price ₩	DH.The0100	₩ / Set

DAIHAN® 22℃~41.5℃ Non-Contact Healthcare IR Thermometer, Precision 0.1 Divi. NEW
 Ideal for Surface Temperature Measuring, with Wrist Strap, 비접촉식 적외선 저온정밀 온도계



Incl. Soft Carry Case

Healthcare IR Thermometer, 22℃~41.5℃

- 위생적인 비접촉식 측정 방식, 0.5초의 빠른 응답속도
- Non-contact Temperature Checker Designed for 22℃~41.5℃
- Ideal for Checking Bath Water and Milk Temperature
- * Fast Response Time : 500ms
- * Temperature Unit is Factory Default as °C



Specifications & Ordering information <L1>

Spec.	Model	DH.The19
Measuring Range		22℃~41.5℃
Resolution & Temp Accuracy		0.1℃ & ±0.3℃
Targeting Distance		3~5cm
Battery		1×9V Battery
Dimension & Weight(g)		44×40×h170mm (LCD Size : 27×17mm) & 140g
Standard Package		Meter, Battery, Manual, Pouch, Wrist Strap, Paper Box
Cat. No. & Price ₩	DH.The3019	₩ 110,010 / Set
Spare ;	DH.The3019.1 Soft Carry Case(Pouch) 176×75×h35mm, Black for DH.The3019	₩ 15,030 / Ea

NEW



Digital Thermometer, with Notification Alarm Function, $-50^{\circ}\text{C} + 300^{\circ}\text{C}$ **NEW**

With Hanging Sensor Cover, $223 \times 34 \times 15\text{mm}$, 디지털 알람 온도계, 안전캡 포함

- 설정된 온도 도달 시 알람 경보 기능, 세척 편리, 긴 사용 수명, 안전한 보관을 위한 안전캡 포함
- Alarm can be Set so as to Sound when Temperature Increases or Decreases
- * Assured Operating Range of Temperature and Humidity : $0^{\circ}\text{C} \sim 40^{\circ}\text{C}$, 85%RH or Lower (No Dew Condensation)
- * Auto Power-off Function * Drip-proof Performance : Equivalent to IPX2

Specifications & Ordering information <L2>

Spec.	Model	O-263WT
Temp. Range (Resolution)		$-50^{\circ}\text{C} + 300^{\circ}\text{C}$ (1 $^{\circ}\text{C}$)
Temp. Accuracy		$\pm 1^{\circ}\text{C}$ (at $0^{\circ}\text{C} \sim 50^{\circ}\text{C}$); $\pm 4^{\circ}\text{C} \sim \pm 6^{\circ}\text{C}$ (at 200°C or higher); others : $\pm 2^{\circ}\text{C}$
Material		Body, Safety Cap : ABS resin; Temperature Sensor : Stainless Steel
Dimensions & Weight		$223 \times 34 \times 15\text{ mm}$ & 35g
Battery		1 \times CR2032 Battery
Standard Package		Meter, Battery, Cap
Cat. No. & Price ₩	SL.The3091	₩ 26,010 / Set

NEW

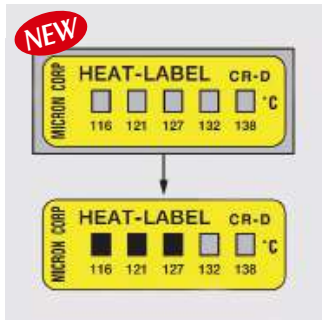

Temperature Indicator Label, 5-Steps, Irreversibility, $40^{\circ}\text{C} \sim 260^{\circ}\text{C}$ **NEW**

Ideal for Measuring High Temperature, $43 \times 16\text{mm}$, 표면 온도 측정지

- Made in UK ■ 접착하여 표면온도 기록, 좁은 공간에도 측정 용이
- * Simply Attach Label to Keep Record of Temperature Distribution and Max. Temperature
- * Discoloration Accuracy $\pm 1^{\circ}\text{C}$
- * Primary Color \rightarrow Discoloration : White \rightarrow Black

SL.Lab9101	"CR-A" Thermo-Label, $40 / 43 / 46 / 49 / 54^{\circ}\text{C}$
SL.Lab9102	"CR-B" , $60 / 65 / 71 / 77 / 82^{\circ}\text{C}$
SL.Lab9103	"CR-C" , $88 / 93 / 99 / 104 / 110^{\circ}\text{C}$
SL.Lab9104	"CR-D" , $116 / 121 / 127 / 132 / 138^{\circ}\text{C}$
SL.Lab9106	"CR-E" , $143 / 149 / 154 / 160 / 166^{\circ}\text{C}$
SL.Lab9107	"CR-F" , $171 / 177 / 182 / 188 / 193^{\circ}\text{C}$
SL.Lab9108	"CR-G" , $199 / 204 / 210 / 216 / 224^{\circ}\text{C}$
SL.Lab9109	"CR-H" , $232 / 241 / 249 / 254 / 260^{\circ}\text{C}$

<L2>

Pk.	Price, ₩
10sheet	38,330
10sheet	38,330
10sheet	38,330
10sheet	38,330
10sheet	38,330
10sheet	42,160
10sheet	42,160
10sheet	42,160

Articles	Cat. No	Description
----------	---------	-------------

SAUTER® 0~1250µm Digital Coating Thickness Gauge Set, with- or without- F- & N- & FN-sensor NEW
 Ideal for Measuring of Layer Thickness of Non-magnetic Coating, with Data Interface RS-232, 도막두께 측정기 세트

NEW



(1) Standard-type

- Supplied by SAUTER® in Germany
- Type F/N : For All Coating as for Type F & N on All Metals as for Type F & N
 - Type F : Measures the Thickness of Non-magnetic Coatings on Magnetic Metals
 - Type N : Measures the Thickness of Insulating Coatings on Non-Magnetic Metals

- * Ergonomic Design for Easy Handling
- * Incl. Data Interface RS-232
- * Base Plate (Aluminum and Iron) and Calibration Foils
- * Offset-Accur : Adjusts the Instrument Precisely on the Locally Measured Range by a Two-point Calibration. This Results in a Superior Accuracy of Approx. 1 % of the Measured Value
- * Selectable Measuring Units : µm, Mil
- * Delivered in a Robust Carrying Case
- * Complete Set with : ① Thickness Gauge, ② Manual, ③ Calibration Foils, ④ Base Plate (Iron & Aluminum), ⑤ F/N External Sensor (Only TE model)

Specifications

- * Measuring range : 0~1250 µm
- * Read-out : 0.1µm (from 0 to 99.9µm), 1µm (above 100µm)
- * Precision : - Standard: 3 % of Measured Value or ±2.5 µm
- * Type F : - Convex : 1.5 mm - Concave : 25 mm
- * Smallest Sample Surface (radius)
- * Dimensions (w×d×h) : 65×28×131 mm
- * Net Weight Approx. 81g
- * Test object : Combination instrument: F/N
- Offset-Accur : 1 % of Measured Value or ± 1 µm
- * Type N : - Convex : 3 mm - Concave : 50 mm
- * Minimal Base Thickness : 0.3 mm
- * Battery Operation, Batteries Standard 4×1.5 V AAA

NEW



(2) External Sensor-type

(1) Standard-type, "TC"

SA.TC1250.0.1FN Test Gauge, for Thickness, 0~1250µm

<L1>	
Set.	Price, ₩
	809,060

(2) External Sensor-type, "TE"

* for Difficult-to-Access Measurements.

- SA.TE1250.0.1FN Gauge, for Thickness, 0~1250µm
- SA.ATE.01 Spare ; (3) External Sensor, Type F, for TE model
- SA.ATE.02 ; (4) External Sensor, Type N, for TE model
- SA.ATC.01 Option ; Data Transfer Software, incl. Interface Cable for TC · TE · TF · TG model

Ea.	Price, ₩	Set.	Price, ₩
			809,060
	197,250		
	206,640		
	169,070		

Optional ;



(3)

(4)

SAUTER® 0~1250µm Premium Digital Coating Thickness Gauge Set, with Scan Mode, 99-Value Internal Memory RS-232 Interface NEW
 Ideal for Paint Coating and Lacquer Coating, with- or without- F- & N- & FN-sensor, with LCD Display Backlight, 고급형 다기능 도막두께 측정기 세트

NEW



(1) Standard-type

- Supplied by SAUTER® in Germany
- LCD Display, Backlight, Display of All Information at a Glance
- Type F/N : For All Coating as for Type F & N on All Metals as for Type F & N
 - Type F : Measures the Thickness of Non-magnetic Coatings on Magnetic Metals
 - Type N : Measures the Thickness of Insulating Coatings on Non-Magnetic Metals

- * Offset-Accur : Adjusts the Instrument Precisely on the Locally Measured Range by a Two-point Calibration. This Results in a Superior Accuracy of Approx. 1 % of the Measured Value
- * Scan Mode for Continuous Measurement or Single Point Measuring Mode
- * Mini Statistics Kit : Displays the Measured Result, the Average Value and the Max and the Min Value
- * Base Plate and Calibration Foils Included
- * Data Interface RS-232 Standard
- * Selectable Measuring Units : µm, Mil
- * Delivered in a Robust Carrying Case
- * Complete Set with : ① Thickness Gauge, ② Manual, ③ Calibration Foils, ④ Base Plate (Iron & Aluminum), ⑤ F/N External Sensor (Only TG model)

Specifications

- * Measuring range : 0~1250 µm
- * Read-out : 0.1µm (from 0 to 99.9µm), 1µm (above 100µm)
- * Precision : - Standard: 3 % of Measured Value or ±2.5 µm
- * Type F : - Convex : 1.5 mm - Concave : 25 mm
- * Minimal Base Thickness : 0.3 mm
- * Battery Operation, Batteries Standard 2×1.5 V AAA
- * Net Weight Approx. 81g
- * Test object : Combination instrument: F/N
- offset-Accur : 1 % of Measured Value or ± 1 µm
- * Type N : - Convex : 3 mm - Concave : 50 mm
- * Dimensions(w×d×h) : 65×35×126 mm

NEW



(2) External Sensor-type

(1) Standard-type, "TF"

SA.TF1250.0.1FN Gauge, for Thickness, 0~1250µm

<L1>	
Set.	Price, ₩
	932,180

(2) External Sensor-type, "TG"

* for Difficult-to-Access Measurements.

- SA.TG1250.0.1FN Gauge, for Thickness, 0~1250µm
- SA.ATG.01 Spare ; External Sensor, Type FN for TG model
- SA.ATC.01 Option ; Data Transfer Software, incl. Interface Cable for TC · TE · TF · TG model

Ea.	Price, ₩	Set.	Price, ₩
			932,180
	244,200		
	169,070		

SAUTER® 1.2~225mm Ultrasonic Compact Material Thickness Gauge, with External Sensor & Data Interface RS-232 NEW

Ideal for Difficult-to-Access Measuring Points, 소형 초음파 두께측정기



Ultrasonic Compact Material Thickness Gauge, 1.2~255mm

- Supplied by SAUTER® in Germany
- Analysis Material : All Hard and Homogeneous Materials such as Cast Iron, Aluminum, Copper, Brass, Zinc, Quartz Glass, Polyethylene, PVC, Grey Cast Iron, Nodular Cast Iron, Steel
- * Can not be used to measure Material as, e.g. Concrete, Asphalt, Teflon or Wood.
- * Can be used when the Walls of the Item to be Measured are not Accessible for Traditional Caliper Gauges.
- * External Sensor for Difficult-to-access Measuring Points
- * Base Plate for Adjustment Incorporated
- * Delivered in a Robust Carrying Case
- * Data Interface RS-232 Included
- * Selectable Measuring Units : mm, Inch
- * Auto-Power-Off Function
- * Complete Set with : ① Thickness Gauge, ② Ultrasonic Sensor, ③ Manual ④ Carrying Case

Specifications

- * Precision : 0.5 % of [Max] + 0.1 mm
- * Dimensions(w×d×h) : 120×65×h30 mm
- * Battery Operation, Batteries Standard 4×1.5 V AAA
- * Net Weight Approx. 164g

<L1>

Cat. No.	Measuring Range Max mm	Readout d mm	Sensor	Sound Velocity m/sec	Set. Price, ₩
SA.TD225.0.1US	1.2-225	0.1	5 MHz / φ 8mm	500-9000	650,780



with Carrying Case

		Ea. Price, ₩
SA.ATC.01	Optional ; Data Transfer Software, incl. Interface Cable	169,070
SA.ATB.US01	; External Sensor, 5MHz, φ6mm for thin Test Materials, Measuring Range (Steel) 1-50mm	356,890
SA.ATB.US02	; External Sensor, 5MHz, φ12mm for Hot Test Materials, Measuring Range (Steel) 1~225mm at Normal Temperatures, 4~100mm at up to 300℃	554,110

SAUTER® 0.75~230mm Ultrasonic Portable Material Thickness Gauge, with External Sensor & Data Interface USB Standard Scan- & Single Point Measuring-Mode, Internal Memory, 휴대용 초음파 두께측정기 NEW



Ultrasonic Portable Material Thickness Gauge, 0.75~230mm

- Supplied by SAUTER® in Germany
- Analysis Material : All Hard and Homogeneous Materials such as Cast Iron, Aluminum, Copper, Brass, Zinc, Quartz Glass, Polyethylene, PVC, Grey Cast Iron, Nodular Cast Iron, Steel
- * Can not be used to measure Material as, e.g. Concrete, Asphalt, Teflon or Wood.
- * Can be used when the Walls of the Item to be Measured are not Accessible for Traditional Caliper Gauges.
- * External Sensor for Difficult-to-access Measuring Points
- * Data Interface USB, Standard (only for Models with Readout [d] = 0,01 mm)
- * Scan Mode (10 Measurements Per Sec.) or Single Point Measuring Mode Possible
- * Internal Memory for up to 20 Files (with up to 100 Values Per File)
- * Selectable Measuring Units : mm, Inch
- * Auto-Power-Off Function
- * Delivered in a Robust Carrying Case
- * Complete Set with : ① Thickness Gauge, ② Ultrasonic Sensor, ③ Manual ④ Carrying Case

Specifications

- * Precision : 0.5 % of [Max] ±0,04 mm
- * Dimensions(w×d×h) : 74×32×h150 mm
- * Battery Operation, Batteries Standard 2×1.5 V AA
- * Net Weight Approx. 245g

<L1>

Cat. No.	Measuring Range Max mm	Readout d mm	Sensor	Sound Velocity m/sec	Set. Price, ₩
SA.TN80.0.01US	0.75-80	0.01	7 MHz / φ 6mm	1000-9999	1,090,460
SA.TN230.0.01US	1.2-200 / 230	0.01 / 0.1	5 MHz / φ 10mm	1000-9999	1,090,460



with Carrying Case

		Ea. Price, ₩
SA.ATU.04	Optional ; Data Transfer Software, incl. Interface Cable	206,640
SA.ATB.US01	; External Sensor, 5MHz, φ6mm for thin Test Materials, Measuring Range (Steel) 1-50mm	356,890
SA.ATB.US02	; External Sensor, 5MHz, φ12mm for Hot Test Materials, Measuring Range (Steel) 3~200mm at Normal Temperatures, 4~100mm at up to 300℃	554,110

Articles	Cat. No	Description
----------	---------	-------------

SAUTER® 0.75~230mm Premium Ultrasonic Portable Material Thickness Gauge Set, with External Sensor NEW
 Ideal for Difficult-to-Access Measuring, Scan- & Single Point Measuring-Mode, Internal Memory for up to 2000 values
 With Data Interface RS-232, 프리미엄 초음파 두께측정기 세트



Premium Ultrasonic Portable Material Thickness Gauge, 0.75~230mm



with Carrying Case

- Supplied by SAUTER® in Germany
- Analysis Material : All Hard and Homogeneous Materials such as Cast Iron, Aluminum, Copper, Brass, Zinc, Quartz Glass, Polyethylene, PVC, Grey Cast Iron, Nodular Cast Iron, Steel
- * Can not be used to measure Material as, e.g. Concrete, Asphalt, Teflon or Wood.
- * Can be used when the Walls of the Item to be Measured are not Accessible for Traditional Caliper Gauges.
- * External Sensor for Difficult-to-access Measurements
- * Base Plate for Adjustment Included
- * Data Interface RS-232
- * Delivered in a Robust Carrying Case
- * Scan Mode (10 Measurements Per Sec.) or Single Point Measuring Mode Possible
- * Internal Memory for up to 20 Files (with up to 100 Values per File)
- * Measuring with tolerance Range (limit-setting Function) : upper and Lower Limiting Can be Programmed Individually. the Process Is Supported by an Audible and Visual Signal
- * Measuring Units : mm, Inch
- * Robust Metal Housing
- * Complete Set with : ① Thickness Gauge, ② Ultrasonic Sensor, ③ Manual ④ Carrying Case

Specifications

- * Precision: 0.5 % of [Max] ±0.04 mm
- * Dimensions(w×d×h) : 76×32×132 mm
- * Battery Operation, Batteries Standard 2×1.5 V AA
- * Net Weight Approx. 345g

<L1>

Cat. No.	Measuring Range Max mm	Readout d mm	Sensor	Sound velocity m/sec	Set. Price, ₩
SA.TU80.0.01US	0.75-80	0.01	7 MHz / φ 6mm	1000-9999	2,057,780
SA.TU230.0.01US	1.2-200 / 230	0.01 / 0.1	5 MHz / φ 10mm	1000-9999	2,057,780

	Optional ;	Ea. Price, ₩
SA.ATU.04	Data Transfer Software, incl. Interface Cable	206,640
SA.ATU.US01	External Sensor, 2.5 MHz, φ 14mm for Thick Samples, in Particular Cast Iron with Rough Upper Surface Measuring Range 3-300mm(Steel)	403,850
SA.ATB.US02	External Sensor, 5MHz, φ 12mm for Hot Test Materials, Measuring Range (Steel) 3-200mm at Normal Temperatures, 4-100mm at up to 300°C	554,110



Vogel® Digital Vernier Calipers, 0~150mm, Resolution 0.01mm NEW
 With 5 Digits LCD Display, mm/inch Changeable, <Germany-made>, 디지털 버니어 캘리퍼스

- 외측 및 내측 치수, 깊이, 단차 등의 정밀한 측정에 가능
- * Ideal for Measuring outside Diameter of Stoppers, Inside Diameter of Tubing and Depth of Holes.
- * Display : 5 Digits LCD
- * Resolution : 0.01mm
- * Accuracy : ±0.03mm
- * Measuring Unit : mm/inch
- * Power Supply : 3V CR2032 × 1ea (Not Included)

<L1>

BC.12116	Digital Vernier Calipers, 0~150mm / 0.01mm, Accu. ±0.03mm	Ea. Price, ₩
		236,780



Vogel® Digital Micrometer, 0~25mm, Readability 0.001mm NEW
 With 5 Digits LCD Display, mm/inch Changeable, <Germany-made>, 디지털 외측 마이크로미터

- 정밀한 나사의 회전을 이용해 길이를 정밀하게 측정하며, 버니어 캘리퍼스 보다 더 정확한 측정이 가능함
- * Display : 5 Digits LCD
- * Readability : 0.001mm
- * Accuracy : ±0.002mm
- * Measuring Unit : mm/inch
- * Power Supply : 3V CR2032 × 1ea (Not Included)

<L1>

BC.12115	Digital Micrometer, 0~25mm / 0.001mm, Accu. ±0.002mm	Ea. Price, ₩
		326,980



힐러(틀새) 게이지 [25매]

TAIWAN®

Metric Feeler Gauge with 25 Strips



구성(두께)

<B3>

세트수량 (25매수)	0.04, 0.05, 0.06, 0.07, 0.08, 0.09, 0.10, 0.15, 0.20, 0.25, 0.30, 0.35, 0.40, 0.45, 0.50, 0.55, 0.60, 0.65, 0.70, 0.75, 0.80, 0.85, 0.90, 0.95, 1.00mm				
ORDER NO.	MODEL NO.	PRICE, ₩ Ea.	규격(mm) 폭(W)×길이(L)	포장단위 Ea. / Pk.	
0355-929	77335-25	9,360	13×85	1 / 50	



Timer 방수

Water-Proof Timer, with Clock, 99min 50sec/1min, 82 × 90 × 18mm, 68g NEW
 Easy to Read with Large Digit Display, with Magnetic Back, 방수 다기능 타이머

■ 젖은 손으로의 조작 가능, 10분/1분/10초 간격으로 설정 가능

- * Operation with Wet Hand Allowed * It has a Clock, Count-Up, Repeat Function
- * Set up Time : Max. 99 minutes 50 seconds, Min. 1 minute
- * Power Supply : Lithium Battery CR 2032 × 1ea (Included for Testing)
- * Size: 82 × 90 × 18mm, Weight : 68g * Auto Power Off : 10 minutes
- * Large Digit Display (49mm × 21mm) * Possible to Set in 10 min., 1min., & 10 sec. Increments

<L2>

SL.Tim3082 Water-Proof Timer, T-543 YE, with Clock, 99min. 50sec., 1min.

Ea.	Price, ₩
	16,150

Articles	Cat. No	Description
----------	---------	-------------



(1)

Hammacher® Premium Holding Tongs, Wironit™ Non-magnetic/Rust-free Stainless-steel **NEW**
 Rigged Jaw, L200 · 255 · 280mm, <Germany-made>, 프리미엄 집게, 독일제, 다용도, 비자성/비부식 특수스텐
 ■ Germany-made 프리미엄급, Wironit™ 특수스텐(18/12 크롬·니켈) 제품; 비자성, 비부식, 내산성/내약품성/내열성 우수
 ■ Wironit™ Special Stainless-steel of 18/12 Cr-Ni; Non-magnetic, Rust-free, Excellent Resistance of Acid / Chemicals / Heat

(1) Oval-shape, L200 · 280 mm

HA.HWN310.20 Tong, Oval-shape, Rigged Jaw-φ4.5mm, L200mm
 HA.HWN312.28 , L280mm

<L1>	
Ea.	Price, ₩
	74,250
	75,790



(2)

(2) Triangle-shape, L255mm

HA.HWN309.25 Tong, Triangle-shape, Rigged Jaw-L35mm, L255mm

Ea.	Price, ₩
	54,120

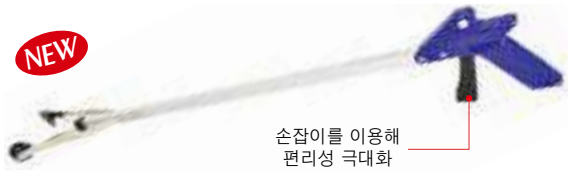

손잡이를 이용해
 편리성 극대화

다용도 만능 집게, Multiuse Utility Tongs, L800mm

- Good for Catching Dirty Objects.
- 활용도가 높은 만능 집게. ■ 안전하고 작동이 쉬운 Design.

0493-831 다용도 만능 집게 "560302", 130×L800mm

KOREA	
<B3>	
Ea.	Price, ₩
	6,920

Tools

Abrasives 수작업 연마제	1151	Masks 마스크	924~930
Adhesives 접착제	15~19	Multi-tools 멀티툴, 다기능	1187
Air Tools 에어공구	1152~1157	Office Supplies 사무용품	731~752
Apparels 보호·안전의류	23~33	Packing Supplies 포장용품	767~773
Batteries/Dry-Cells 배터리	378	Pliers 니퍼/뺨치/플라이어	1187~1188
Boxes 박스	179~184	Pumps 펌프류	821~840
Brushes 브러쉬/솔	185~189, 251~254	Putty Knives 헤라/스크래퍼	1189
Carts/Hand Trucks 카트/수레	208~215	Radiation Shields 방사선 차폐막	932
Clamps/holders 클램프/홀더	232~247	Riveters 리베터	1153, 1189~1190
Cleaning Supplies 청결·청소용품	249~272	Road Safety Aids 도로안전 보조용품	932~934
Copper Pipe Processing 동관가공용품	1158~1159	Rulers/Measuring Devices 측정자	905 ~ 908
Crimpers & Strippers 전공용 압착기와 스트리퍼	1159~1160	Safety Supplies 안전용품	909~936
Cutters 커터/절단기	1160~1161	Saws 톱	1190~1191
Cutting Tools 절삭공구	1161~1164	Scissors 가위	952~958
Drills 드릴	1164	Scoops 스키프	959 ~ 963
Drilling Tools 드릴공구	1164~1169	Screw Extractor Sets 반대탭/히다리탭	1191
Drivers 드라이버	1169~1171	Screws/Nails Set 각종못 세트	1191~1192
Dryers 건조기	379~381	Shoes 안전화	973~974
Earmuffs/Covers 귀덮개	917~918	Silicone Sealant & Gun 실리콘 실란트 & 건	18~19
Ear Plugs 귀마개	919	Soldering Irons 납땀 인두기	1193
Electric Tools 전동공구	1172~1184	Spatulas 스페츨러	985 ~ 993
Air Guns, Hot Air 열풍건조기	1172	Staplers 타카/스태플러	1153~1154
Blowers 송풍기	1172	Suction Lifters 흡착기(리프터)	1192
Brush Cutters 예초기	1180	Tapes 각종 테이프류	1101~1112
Cleaners 세척/청소기	1172~1173	Tapping Machines 탭핑머신	1164
Cutting & Grinding Wheels/Discs 절단석/연마석	1182~1184	Thickness Gauges 두께측정기	1136~1139
Drills 드릴	1174~1175	Tool Boxes 공구박스	183~184
Drivers 드라이버	1175~1177	Tool Kits 공구세트	1194~1200
Glue Guns 글루건	1177	Tool Pouches "TOUGHBUILT" 공구집, 착용식	1195~1200
Grinders 그라인더	1177~1179	Torches 가스토치	519~520
Sanders 샌더	1178~1179	Tubings/Hoses 튜빙/호스	1252~1257
Saws 톱/쏘	1179~1180	Urethane Foam & Guns 우레탄 폼 & 폼건	1201
Wrenches 렌치	1181	Vacuum Cleaners 진공청소기	1173
Accessories 액세서리	1181~1184	Waste Disposal 폐기물 수거	1315~1319
Electrical Appliances 전기용품	383~390	Water Cleaners 고압 물 세척기	272
Face Shields 보안면	920~921	Welding 용접	1202~1215
Fire Extinguishers 소화기	1185	Electric Machines 전기용접기	1202~1204
Gas Appliances 가스기구	513~522	Gas 가스용접기	1204~1206
Gas Regulators 가스 조절기	1205~1206	Welding Supplies 용접기자재	1206~1210
Gas Welding 가스용접기	1204~1206	Accessories(Parts) 용접 부품	1211~1215
Gloves 위생·안전 장갑	543~558	Wipers 와이퍼	1331~1335
Goggles/Spectacles 보안경	922~923	Wrenches 렌치	1216~1222
Hammers 망치	1185~1186		
Harness 안전벨트	924		
Heaters 히터류	586		
Helmets 안전모	924		
Knives 칼	669~674		
Levels 수평·수준계	682~683		
Lights & Lanterns 조명기구	684~687		
Lubricants/Greases 윤활 방청제류	689~691		
Lux Meters 조도계	692		

Articles Cat. No Description

DEERFOS 연마천 스위트, Abrasive Cloth Sheet

- 연마천 228×280mm
- 표준 1권 : 50장

KOREA



DEERFOS 연마지 스위트(샌드 페퍼), Abrasive Paper Sheet

- 연마종이 228×280mm
- 표준 1권 : 100장

KOREA

<B3>

ORDER NO.	입도(#)	PRICE ₩		포장단위	
		dh pk	권	dh pk	표준 권
0271-479	40	830	34,480	1장	50장
0271-480	50	820	33,690	1장	50장
0271-481	60	820	33,690	1장	50장
0271-482	80	800	32,870	1장	50장
0271-483	100	800	32,870	1장	50장
0271-484	120	780	32,060	1장	50장
0271-485	150	780	32,060	1장	50장
0271-486	180	780	32,060	1장	50장
0271-487	220	780	32,060	1장	50장
0271-488	320	780	32,060	1장	50장
0271-489	400	780	32,060	1장	50장

ORDER NO.	입도(#)	PRICE ₩		포장단위	
		dh pk	권	dh pk	표준 권
0271-491	80	550	44,890	1장	100장
0271-492	100	510	41,670	1장	100장
0271-493	120	510	41,670	1장	100장
0271-494	150	500	40,160	1장	100장
0271-495	180	500	40,160	1장	100장
0271-496	220	500	40,160	1장	100장
0271-497	320	500	40,160	1장	100장
0271-498	400	500	40,160	1장	100장
0271-499	600	500	40,160	1장	100장
0271-500	800	500	40,160	1장	100장
0271-501	1,000	530	43,280	1장	100장
0271-502	1,200	530	43,280	1장	100장
0271-503	1,500	550	44,890	1장	100장
0271-504	2,000	610	49,730	1장	100장



3M® Non-slip Grippy Sanding Cloth, High Flexibility, 139mm×114mm, Thickness 1mm
Ideal for Hand Sanding Application, Suitable for Wet & Dry Sanding, Reusable, **논슬립 사각 연마천**

- 곡면 작업 용이한 유연성 ■ 건식 & 습식 연마 모두 가능 ■ 롤타임으로 간편하게 뜯어서 사용 가능
 - 세척후 재사용 가능 ■ 입도(#)가 작을수록 거칠음 ■ 1Pk=1Roll=200Sheets
- * Excellent Abrasive Performance in Both Wet and Dry Sanding * Provides Ease-of-use
* Reusable after Cleaning * Ease to Cut

3M.08.35109	Abrasive Sanding Cloth, Non-slip, #P320
3M.08.35110	, #P400
3M.08.35111	, #P600
3M.08.35112	, #P800
3M.08.35113	, #P1000
3M.08.35114	, #P1200
3M.08.35115	, #P1500
3M.08.35116	, #P2000

<B4>

Pk.	Price, ₩	Cs.	Price, ₩
20sheets	23,480	4pk	86,950
20sheets	23,480	4pk	86,950
20sheets	23,480	4pk	86,950
20sheets	23,480	4pk	86,950
20sheets	23,480	4pk	86,950
20sheets	23,480	4pk	86,950
20sheets	23,480	4pk	86,950
20sheets	23,480	4pk	86,950
20sheets	23,480	4pk	86,950



3M® Abrasive Lapping Film Sheet, Polyester Film with Aluminum Oxide, 216mm×279mm
Ideal for Fast Finish Polishing, Ultraprecision, Grit 2,000~15,000, **랩핑필름시트, 초정밀 연마지**

- 균일하고 초정밀한 마무리를 단시간에 작업 ■ Micron Grade로 관리된 연마 입자 코팅 ■ 입도(#)가 작을수록 거칠음
- * Ideal for Fiber Optic Connector Polishing, Flat Lapping, Superfinishing, Media Head finishing, Hard Disk Drive Lube Buff

3M.08.1047	Lapping Film Sheet, #2,000, Sky-blue
3M.08.1046	, #3,000, Brown
3M.08.1045	, #4,000, Pink
3M.08.1044	, #6,000, Dark-green
3M.08.1043	, #8,000, Green
3M.08.1042	, #10,000, Grey
3M.08.1041	, #15,000, White

<B4>

Pk.	Price, ₩
200sheet	406,050
200sheet	417,000
200sheet	382,230
200sheet	661,400
200sheet	475,930
200sheet	1,042,000
200sheet	966,000

3M® Softback Sanding Sponge, for Handy Sanding, Aluminum Oxide Mineral Coated, 114×139mm, Thickness 5mm
Ideal for Sanding Surface, Highly Versatile Abrasive, Waterproof, Grit 120~1,500, **스폰지연마재, 페퍼**



- 목적에 따라 거칠기 선택 가능 ■ 곡면 작업이 용이한 유연성과 복원력이 뛰어나 ■ 입도(#)가 작을수록 거칠음
- * Waterproof Bonding System Allows for Either Wet or Dry Sanding Applications * A Variety of Abrasive Grades
* Suitable for Sanding Such as Wood, Metal, Fiberglass, Plastic, Gel Coat and Marine Paints

3M.08.2606	Sanding Sponge, #120~180, Medium
3M.08.2604	, #320~400, Fine
3M.08.2602	, #500~600, Superfine
3M.08.2601	, #600~800, Ultrafine
3M.08.2600	, #1200~1500, Microfine

<B4>

Pk.	Price, ₩	Cs.	Price, ₩
20ea	29,040	6pk	161,290
20ea	29,040	6pk	161,290
20ea	29,040	6pk	161,290
20ea	29,040	6pk	161,290
20ea	29,040	6pk	161,290
20ea	29,040	6pk	161,290

EXP 에어 콤프레샤 (저소음), Silent Air Compressor Oil-less

다국적

- Compact Oil-Free/Silent-type
- 오일리스 타입
- 저소음 제품으로 실내 작업 시 최적의 효과



(1) 1HP, 8Lit

(2) 2HP, 24Lit
(3) 3HP, 40Lit

(1) 1HP(8Lit)

<B3>

	전압(V/Hz)	탱크용량(ℓ)	규격(cm)(L×D×H)	
SAC-10S	220/60	8	48×22×49	
ORDER NO.	MODEL NO.	PRICE, ₩	출력(HP)	중량(kg)
▶ 0296-054	SAC-10S	174,440	1.0	14.4

(2) 2HP(24Lit) and (3) 3HP(40Lit)

	전압(V/Hz)	탱크용량(ℓ)	규격(cm)(L×D×H)	
SAC-20S	220/60	24	53×27.5×58	
SAC-30S	220/60	40	66×28×64	
ORDER NO.	MODEL NO.	PRICE, ₩	출력(HP)	중량(kg)
▶ 0296-051	SAC-20S	196,990	2.0	25
▶ 0296-055	SAC-30S	356,720	3.0	38

m7 에어드릴, Air Drill

TAIWAN



QE-333
3/8"



좌·우 변환 버튼

키척 타입
카플러 : 1/4"

- 콜렛크기 3/8"(10mm), 회전 1800rpm
- 공기압 6.3bar, 소음 92dBA
- 전장 230mm, 중량 1.1kg

<B3>

ORDER NO.	0459-935
PRICE, ₩	69,880



QE-633
3/8"



좌·우 변환 버튼

키레스척 타입
카플러 : 1/4"

- 콜렛크기 3/8"(10mm), 회전 1800rpm
- 공기압 6.3bar, 소음 72dBA
- 전장 210mm, 중량 1.1kg

ORDER NO.	0522-071
PRICE, ₩	158,760



QE-343
1/2"



좌·우 변환 버튼

키척 타입
카플러 : 1/4"

- 콜렛크기 1/2"(13mm), 회전 800rpm
- 공기압 6.3bar, 소음 97.5dBA
- 전장 230mm, 중량 1.8kg

ORDER NO.	0459-946
PRICE, ₩	116,340

m7 에어 스크류 드라이버, Air Screw Driver

TAIWAN



RA-101



좌·우 변환 버튼

트윈해머 타입
능력 : M4
카플러 : 1/4"

- 비트크기 1/4"(6.35mm)
- 토크 5~12Nm, 회전 9000rpm
- 공기압 6.3bar, 소음 85.7dBA
- 전장 166mm, 중량 0.6kg

<B3>

ORDER NO.	0459-980
PRICE, ₩	72,040



RA-2242

능력 : M5
카플러 : 1/4"



- 비트크기 1/4"(6.35mm)
- 토크 24.4~35.2Nm
- 공기압 6.3bar, 소음 88dBA
- 회전 13,000rpm
- 전장 150mm, 중량 0.9kg

ORDER NO.	0522-865
PRICE, ₩	118,590

Articles	Cat. No	Description
----------	---------	-------------

QT7 에어 앵글 그라인더, Air Angle Grinder, ϕ 100mm Pad TAIWAN

QB-144



슬리브 타입
정지
작동

슬리브 타입
카플러 : 1/4"

- Pad 크기 ϕ 100×16mm, 스펀들 M10×P1.5
- 11000rpm, 공기압 90PSI, 모터 0.78HP
- 소음 88dBA, 전장 226mm, 중량 1.8kg

<B3>

ORDER NO.	0521-452
PRICE, ₩	208,750

QT7 에어 앵글 그라인더, Air Angle Grinder, ϕ 100mm Pad TAIWAN

QB-7114M



레버 타입

레버 타입
카플러 : 1/4"

- Pad 크기 ϕ 100mm, 스펀들 M10×P1.5
- 11000rpm, 공기압 90PSI, 모터 1.3HP
- 소음 90dBA, 전장 232mm, 중량 1.8kg

<B3>

ORDER NO.	0521-453
PRICE, ₩	272,440

QT7 에어 샌더, Air Sander ϕ 100mm Pad TAIWAN

QB-53802



흡입형
카플러 : 1/4"

- 11000rpm, 모터 0.24HP
- 공기압 6.3bar, 소음 96.2dBA
- 전장 153mm, 중량 1.0kg

<B3>

ORDER NO.	0459-947
PRICE, ₩	174,940

QT7 에어 해머, Air Hammer TAIWAN

SC-331C



치즐 5개 포함
카플러 : 1/4"

- 샥크 10.2mm, 스트로크 71, 소음 92dBA
- 타격수 3000bPM, 공기압 6.3bar
- 전장 190mm, 중량 1.7kg

<B3>

ORDER NO.	0459-981
PRICE, ₩	133,780

QT7 에어 리베터, Air Hydraulic Riveter TAIWAN

PA-301



카플러 : 1/4"

- 인력 1045 gk.f, 스트로크 16mm
- 능력 2.4~4.8mm, 공기압 90PSI
- 소음 79.7dBA, 진동 0.3m/s², 중량 1.5kg

<B3>

ORDER NO.	0459-968
PRICE, ₩	130,150

QT7 에어 톱, Air Saw/Cutter TAIWAN

QD-291



카플러 : 1/4"

- 스트로크 10mm, 타격수 9000SPM, 콜렛 5mm
- 공기압 90PSI, 소음 80dBA, 진동 2.4m/s²
- 전장 235mm, 중량 0.6kg

<B3>

ORDER NO.	0459-982
PRICE, ₩	98,790

Option, Air Saw Blades Set QD-932 ; with 10 Pcs.

ORDER NO.	0519-261
PRICE, ₩	19,600



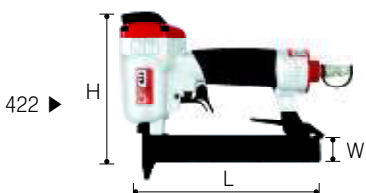

422 ▶ H
L
W

사용핀	용도
F30(1830)	F10, 15, 20, 25, 30
1013	1005, 1006, 1008, 1010, 1013
422	406, 408, 410, 413, 416, 419, 422
1022	1006, 1008, 1010, 1013, 1016, 1019, 1022
F50(1850A)	F15, 20, 30, 35, 40, 45, 50
T50(BN16/50)	T30, 35, 40, 45, 50
T64(BN16/64)	T30, 35, 40, 45, 50, 57, 64

캐비닛, 액자
가구등
인테리어 작업

인테리어, 가구,
거울, 액자, 창문틀,
문 물딩작업

JIT 에어 범용 타카, Air General Purpose Stapler KOREA

CE ISO 9001

<B3>

ORDER NO.	MODEL NO.	PRICE, ₩	규격(mm) (H×L×W)	중량 (kg)
0231-828	F30(1830)	65,570	189×250×59	1.1
0232-019	1013		146×229×44	0.88
▶ 0231-827	422		179×250×59	1.2
0231-829	1022		179×250×59	1.2
0270-814	F50(1850A)	114,670	244×244×59	1.2
0232-021	T50(BN16/50)	147,890	263×295×78	1.84
0231-833	T64(BN16/64)	149,460	273×293×78	1.99



에어 알루미늄 타카, Air Aluminum Stapler

KOREA



ISO 9001



사용핀

용도

<B3>

CS26/64	19, 22, 25, 32, 38, 45, 50, 57, 60, 64	간판 프레임 작업, 알루미늄 판재 접목작업
---------	--	-------------------------

ORDER NO.	MODEL NO.	PRICE, ₩	규격(mm) (H×L×W)	중량 (kg)
0232-022	722	114,670	179×250×59	1.2



타카핀, 4종, Stapler Staples

KOREA

<B3>

(1) Model - 410~422

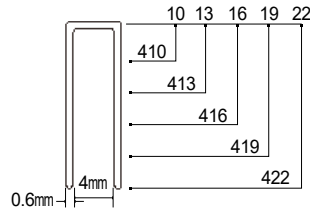

ORDER NO.	MODEL NO.	PRICE, ₩ PK.	포장단위 Pk. / Cs.	PCS	적용타카
0270-832	410	5,020	1 / 40		
0270-833	413	5,400	1 / 30		
0270-841	416	5,950	1 / 26	5,000	422
0270-834	419	6,700	1 / 23		
0270-835	422	7,440	1 / 20		

(2) Model - 1005~1022

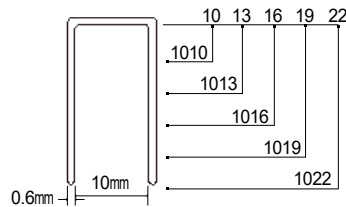

ORDER NO.	MODEL NO.	PRICE, ₩ PK.	포장단위 Pk. / Cs.	PCS	적용타카
0375-373	1005	4,400	1 / 40		1013
0270-838	1006	4,280	1 / 40		1013
0270-842	1008	4,840	1 / 36	5,000	1013, 1022
0270-839	1010	5,210	1 / 32		
0270-829	1013	5,950	1 / 24		
0270-837	1016	7,070	1 / 20		
0270-836	1019	8,000	1 / 20	5,000	1022
0270-830	1022	8,370	1 / 16		

(3) Model - F10~F50

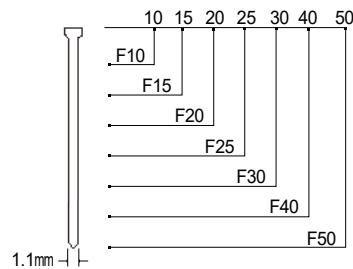

ORDER NO.	MODEL NO.	PRICE, ₩ PK.	포장단위 Pk. / Cs.	PCS	적용타카
0356-378	F10	4,090	1 / 36		
0270-844	F15	5,210	1 / 30		
0270-845	F20	6,510	1 / 25	5,000	F30
0270-826	F25	7,070	1 / 20		
0270-847	F30	8,000	1 / 16		
0270-848	F40	11,160	1 / 12	5,000	F50
0270-849	F50	12,640	1 / 10	5,000	F50

(4) Model - T30~T64

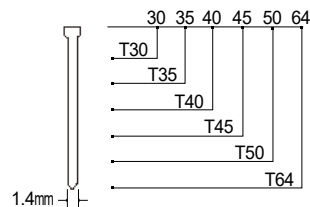

ORDER NO.	MODEL NO.	PRICE, ₩ PK.	포장단위 Pk. / Cs.	PCS	적용타카
0270-850	T30	16,740	1 / 6		
0375-389	T35	16,740	1 / 6	5,000	T50
0375-390	T40	17,640	1 / 6		
0270-852	T45	18,590	1 / 6		
0270-853	T50	20,060	1 / 4		T50
0312-129	T57	22,320	1 / 4	5,000	T-64
0270-851	T64	24,540	1 / 4		T-64

Articles Cat. No Description

m7 에어 임팩트 렌치, Air Impact Wrench TAIWAN



NC-4255Q
1/2", 카플러 : 1/4"

트윈해머타입 / 후방배기

ORDER NO.	0455-364
PRICE, ₩	211,000



NC-3210
3/8", 카플러 : 1/4"

트윈해머타입 / 후방배기

ORDER NO.	0459-948
PRICE, ₩	216,100



NC-6217
3/4", 카플러 : 3/8"

트윈해머타입 / 후방배기

ORDER NO.	0459-949
PRICE, ₩	565,960



NC-6255Q
3/4", 카플러 : 1/4"

트윈해머타입 / 후방배기

ORDER NO.	0519-532
PRICE, ₩	343,000



NC-8237
1", 카플러 : 3/8"

트윈해머타입

ORDER NO.	0459-950
PRICE, ₩	812,920



NC-8226
1", 카플러 : 1/2"

트윈해머타입 / 측면배기

ORDER NO.	0459-951
PRICE, ₩	915,820

							
	규격 Inch	능력 mm	최대토크 Nm	회전수 rpm	중량 kg	소음 dBA	진동 m/s ²
NC-4255Q	1/2	25	1,627	8,500	1.70	85.0	4.7
NC-3210	3/8	13	474	10,000	1.50	92.1	3.6
NC-6217	3/4	30	1,898	4,800	5.00	92.0	5.0
NC-6255Q	3/4	25	1,890	8,500	1.90	85.0	4.5
NC-8237	1	33	2,441	4,500	5.70	92.0	6.1
NC-8226	1	33	2,441	6,000	8.40	102.0	9.3

m7 에어 라쳇 렌치, Air Ratchet Wrench TAIWAN



(1) NE-361, 3/8"
1/4" 카플러, 후방배기

■ 최대토크 50Nm, 회전 230rpm
■ 소음 88dBA, 중량 0.5kg

ORDER NO.	0455-365
PRICE, ₩	73,020



(2) NE-421, 1/2"
1/4" 카플러, 전방배기

■ 최대토크 68Nm, 회전 160rpm
■ 소음 92.8dBA, 중량 1.04kg

ORDER NO.	0453-308
PRICE, ₩	71,940

Articles Cat. No Description

에어 구리스 펌프 KOREA
Air Grease Pump, 2C'

일반용

- 적정사용공기압력 5kgf/cm² 사용 (압력조정기 부착사용)
- 최대토출량 : 320cc/분
- 최대토출압 : 250kgf/cm²
- 비율 : 45:1
- 용량 : 20 l

<B3>

ORDER NO.	MODEL NO.	PRICE, ₩	호스(M)	중량(kg)
0142-559	CHP-88	307,300	1/4 PT×3	11

에어 소형 구리스 펌프, 500ml KOREA
Handy Air Grease Pump

- 용량 : 500cc, 사용시 구리스를 통에 넣어서 사용 (카트리지가 아님)

<B3>

ORDER NO.	MODEL NO.	PRICE, ₩
0339-958	500C	74,790

에어 터빈 · 마이크로 그라인더, Air Turbine · Micro Grinder KOREA ISO 9001 CE

DMG-3M ▶

- DT-1000
 - 고속 소형 다단 축류형 터빈 구조
 - 초고속 회전
 - 내구성 우수
 - 전방배기
- DMG-3M
 - 금형 및 가공 후 면취 작업 사용
 - 저소음 후방배기

<B3>

ORDER NO.	MODEL NO.	PRICE, ₩	회전수 (rpm)	전장 (mm)	중량 (kg)
▶ 0412-214	DMG-3M	155,240	65,000	162	0.13

원터치 피팅, One-Touch Fitting KOREA

(1) PG-type

<B3>

ORDER NO.	MODEL NO.	PRICE, ₩ Ea.	포장단위 Ea. / Pk.
0279-017	PG 06-04	1,020	1 / 10
0279-019	PG 08-06	950	1 / 10
0279-021	PG 10-08	1,090	1 / 10
0279-023	PG 12-10	1,330	1 / 10

(2) PY-type

ORDER NO.	MODEL NO.	PRICE, ₩ Ea.	포장단위 Ea. / Pk.
0278-964	PY 0600	870	1 / 10
0278-965	PY 0800	950	1 / 10
0278-966	PY 1000	1,170	1 / 10
0278-967	PY 1200	1,560	1 / 5

(3) PUC-type

ORDER NO.	MODEL NO.	PRICE, ₩ Ea.	포장단위 Ea. / Pk.
0278-946	PUC 0600	630	
0278-947	PUC 0800	630	1 / 10
0278-948	PUC 1000	710	1 / 10
0278-949	PUC 1200	1,020	1 / 10

(4) PUT-type

ORDER NO.	MODEL NO.	PRICE, ₩ Ea.	포장단위 Ea. / Pk.
0278-958	PUT 0600	710	1 / 10
0278-959	PUT 0800	790	1 / 10
0278-960	PUT 1000	950	1 / 10
0278-961	PUT 1200	1,330	1 / 5

Articles	Cat. No	Description
----------	---------	-------------

에어건 (플라스틱), PVC Air Gun, Stainless-steel Noggle
 KOREA
 ISO 9001



직선
 곡선

200mm

▲ KD-200S

- 스테인레스 노즐을 채택하여 습기를 머금은 공기를 분사하더라도 에어건 자체에 녹이 발생하지 않는 고급 사양의 에어건
- 인체공학적으로 설계된 바디 디자인은 우수한 작업성 및 피로도 저하 확보
- 공기 주입구 나사 PT 1/4

<B3>

ORDER NO.	MODEL NO.	PRICE, ₩ Ea.	노즐 길이	타입	포장단위 Ea. / Pk.
0259-122	KD-100S	7,550	100	직선	1 / 15
▶ 0259-123	KD-200S	8,830	200	직선	1 / 10
0259-124	KD-300S	10,590	300	직선	1 / 10
0259-125	KD-100L	7,550	100	곡선	1 / 15
0259-126	KD-200L	8,830	200	곡선	1 / 10
0259-127	KD-300L	10,590	300	곡선	1 / 10

에어건 (메탈), Metal Air Gun, Aluminum Noggle
 KOREA
 ISO 9001



직선
 곡선

200mm

▲ KSD-200S

- 순간 에어 토출량이 높은 사용에 적합하며, 알루미늄 노즐의 채택으로 금형, 세차, 등 민감한 용처에도 안전하게 사용할 수 있도록 고급 사양의 에어건
- 공기 주입구 나사 PT 1/4

<B3>

ORDER NO.	MODEL NO.	PRICE, ₩ Ea.	노즐 길이	타입	포장단위 Ea. / Pk.
0259-129	KSD-100S	11,180	100	직선	1 / 10
▶ 0259-130	KSD-200S	12,550	200	직선	1 / 10
0259-131	KSD-300S	14,420	300	직선	1 / 10
0259-132	KSD-100L	11,180	100	곡선	1 / 10
0259-133	KSD-200L	12,550	200	곡선	1 / 10
0259-134	KSD-300L	14,420	300	곡선	1 / 10



Bosch® Analog & Digital Hot Air Gun, with Controller & Safety Device, 220V, 50/60Hz With Attemperator, 50°C~630°C Controlled, 150~500ℓ/min(wind Speed), 열풍건조기

- * Button type : Convenient Handle with one Hand
- * Lightweight and Easy Design, with Safety Device
- * Adjustable Heat & Air : up to 630°C(Heat), and up to 500 Lit(wind Speed)

(1) Analog-type, "GHG16-50", 300°C~500°C, 240~450ℓ/min(wind Speed)

* Two Step Control
0527-680 Heat Gun, 300~500°C, 520g, 240~450ℓ/min, 1,600w

Ea.	Price, ₩
	76,440



(2) Digital-type, "GHG20-63", 50°C~630°C, LCD Display, 150~500ℓ/min(wind Speed)

* Three Step Control
0527-681 Heat Gun, 50~630°C, 650g, 150~500ℓ/min, 2,000w

Ea.	Price, ₩
	141,120

에어 호스릴(자동), Auto Air Hose Reel
 KOREA
 CE ISO 9001





(1) N 타입

- 경량형 프레임, 유연성 호스, 간편한 설치
- 자동차 정비소, 일반 산업현장, 실습실
- 벽 및 천정(설치높이 4M이내)
- 재질 : 폴리우레탄

(2) ST 타입

- 고탄력 스프링, 유연성호스, 간편한 설치
- 자동차 정비소, 일반 산업현장, 실습실
- 벽 및 천정(설치높이 4M이내)
- 재질 : 폴리우레탄

(3) 패키지 타입

- 연결넛플 PT10
- 자동권취, ABS 플라스틱 패키지
- 건설현장, 일반산업현장, 실습실
- 고정형, 벽 및 천장(설치높이 3M이내)
- 재질 : 폴리우레탄

(1) N-type <B3>

ORDER NO.	MODEL NO.	PRICE, ₩	규격 내경(φ)×외경(φ)	길이 (M)	중량 (kg)
0320-609	RA-620N	92,430	6.5×10	20	7.6
0320-596	RA-815N	93,110		15	8.0
0320-597	RA-820N	105,950	8×12	20	8.5
0320-598	RA-830N	129,570		30	7.0

(2) ST-type

ORDER NO.	MODEL NO.	PRICE, ₩	규격 내경(φ)×외경(φ)	길이 (M)	중량 (kg)
0326-335	RA-630ST	174,650	6.5×10	30	10.0
0320-619	RA-820ST	148,960	8×12	20	11.7
0320-616	RA-830ST	189,340		30	13.5

(3) Package-type

ORDER NO.	MODEL NO.	PRICE, ₩	규격 내경(φ)×외경(φ)	길이 (M)	중량 (kg)
0376-153	PAR-820	164,640	8×12	20	10.3
0376-154	PAR-830	206,980		27	11.5
0376-156	PAR-1120	206,980	11×16	20	11.7

Articles

Cat. No

Description

ROTHENBERGER 동 파이프 확관기 세트 GERMANY
Copper Pipe Expander Set



<B3>

ORDER NO.	MODEL NO.	PRICE, ₩ Pk.	포장단위 Pk.
0514-160	612000	392,000	1

ROTHENBERGER 동 파이프 확관기 헤드 GERMANY
Copper Pipe Expander Head



<B3>

ORDER NO.	MODEL NO.	규격	PRICE, ₩ Ea.	포장단위 Ea.
0514-177	1.1008	8mm	131,960	
0514-178	1.1052	3/8"	50,490	
0514-179	1.1053	1/2"	41,400	1
0514-180	1.1054	5/8"	40,150	
0514-181	1.1055	3/4"	41,400	
0514-182	1.1056	7/8"	43,980	1

KSD 동파이프 확관기 세트 KOREA
Copper Pipe Expander Set



<B3>

ORDER NO.	MODEL NO.	PRICE, ₩ Pk.	포장단위 Pk.
0211-076	LTE-70A	238,150	1

KSD 동파이프 확관기 헤드 KOREA
Copper Pipe Expander Head

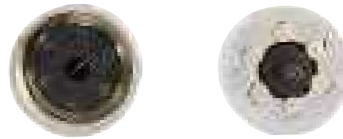

<B3>

ORDER NO.	규격(INCH)	PRICE, ₩	적용기종
0376-734	3/8		
0376-735	1/2		
0376-736	5/8	35,200	LTE-70A
0376-737	3/4		
0376-738	7/8		
0376-739	1	35,200	LTE-70A
0376-740	1 1/8		

- 빠르고 정밀한 관 확장용
 - 난방가스, 정유, 증기, 에어컨 등의 배관작업
- 구성
- 3/8, 1/2, 5/8, 3/4, 7/8, 1, 9/8

ROTHENBERGER 동 파이프 프라밍 확관기 세트, Copper Pipe Flaring Tool Set KOREA

▶ 커터 & 리머 포함



▲ 커터

▲ 리머

- 퀵 핸들에 의해 핸들을 바꿀 필요 없음
- 편안한 연속회전 작업이 가능
- 정전, 역전은 핸들을 상, 하로 슬라이드 시키는 것만으로 전환, 콕전환
- 핸들 중앙부에 전환 손잡이가 없어 손바닥에 불쾌감을 주지 않아 손에 딱 맞음
- 커터, 리머 포함

<B3>

ORDER NO.	MODEL NO.	PRICE, ₩ Ea.	사용범위(INCH)	포장단위 Ea. / Cs.
0335-638	DW-206	115,640	1/8~3/4	1 / 10

ROTHENBERGER 미니 동파이프 커터, Mini Tube Cutter TAIWAN



- 더 얇고 날카로운 날 사용으로 쉽게 커팅 가능
- 손쉽게 날교체 가능

<B3>

ORDER NO.	MODEL NO.	PRICE, ₩ Ea.	사용범위(mm)	전장(mm)	포장단위 Ea. / Pk.
0444-878	7915A-19	9,460	3~19	62	1 / 10
0444-879	7915A-28	16,600	3~28	70	1 / 10

Articles Cat. No Description

ROTHENBERGER 동 파이프 커터, Tube Cutter for Copper GERMANY



<B3>

ORDER NO.	MODEL NO.	PRICE, ₩ Ea.	사용범위(mm)	포장단위 Ea.
0514-121	7.0029	47,730	6-42	1

ROTHENBERGER 동 파이프 커터 날, Tube Cutter Wheel GERMANY



<B3>

ORDER NO.	MODEL NO.	PRICE, ₩ Ea.	날규격(mm)		포장단위 Ea. / Cs.
			외경	내경	
0514-139	7.0017D	4,910	18.5	4.8	1 / 5
0514-140	7.0028D	6,530	23.6	4.8	1 / 3

Asia First Brand 동파이프밴더, Tube Bender TAIWAN



<B3>

ORDER NO.	MODEL NO.	PRICE, ₩ Ea.	규격 (INCH)	최저가능 규격(INCH)	반경 (INCH)	포장단위 Ea.
▶ 0344-493	CT-364A-04	23,330	1/4	1/8	9/16	
0344-499	CT-364A-05	24,410	5/16	3/16	3/16	
0344-498	CT-364A-06	33,240	3/8	1/4	1/4	1
0344-492	CT-364A-08	41,860	1/2	3/8	3/8	
0344-501	CT-364A-10	64,100	5/8	1/2	1/2	
0344-496	CT-364A-12	83,210	3/4	5/8	5/8	1

, Crimpers/Strippers 압착기/스트리퍼

SUNKEY 압착기 (자체조절형), Self Adjustable Crimper TAIWAN



- 정방형 압착 기능
- 펜홀더자 압착 0.2~6mm (SQ)
- 슬리브 마감처리
- 피로 감소
- 반복된 작업에도 높은 압착 품질
- 압착 강도 조절
- 강력하고 빠른 압착
- 간단한 조작
- 가벼운 무게

<B3>

ORDER NO.	MODEL NO.	PRICE, ₩ Ea.	포장단위 Ea. / Pk.
0470-476	SES-8165A	30,040	1 / 6

SUNKEY 압착기, Ratchet Crimper TAIWAN



- 스프링 내장형
- 일반 수동형 제품의 50% 힘으로 압착 가능
- 원하는 위치에 정확히 압착 가능



<B3>

ORDER NO.	MODEL NO.	PRICE, ₩ Ea.	사용범위(mm)	포장단위 Ea. / Pk.
0459-401	SCT-55	26,310	0.3, 0.5, 1.25, 2, 3.5, 4.5, 5.5	1 / 6
0459-408	SCT-14	32,140	1.25, 2, 5.5, 8, 14	1 / 6
0459-409	SCT-38	63,340	8, 14, 22, 38	1 / 6

ET 터미널 압착기, Crimping Tool For Non-Insulated Terminal TAIWAN



- 사용범위
- 1.5, 2.5, 6, 10



<B3>

ORDER NO.	MODEL NO.	PRICE, ₩ Ea.	전장(mm)	포장단위 Ea. / Pk.
0457-726	6AC52-11	26,880	270	1 / 6
0457-727	6AC52-12	30,240	300	1 / 6

Articles

Cat. No

Description

SUNKEY 이지스트리퍼, Easy Stripper

TAIWAN



<B3>

■ 피복 후 배출구가 있어 잔여물 배출 용이

ORDER NO.	MODEL NO.	PRICE, ₩ Ea.	포장단위 Ea. / Pk.
0470-475	SES-665	19,300	1 / 10

ORDER NO.	MODEL NO.	PRICE, ₩ Ea.	포장단위 Ea. / Pk.
0403-621	SES-668	22,210	1 / 10

SES-665 SES-668

일반와이어절단 및 스트리핑	0.05~8mm
비절연터미널 압착	1.5~6mm
절연터미널 압착	1.5~6mm
오토 이그니션 터미널 압착	7~8mm
ROMAX케이블 스트리핑	14/2, 12/2
NM-B케이블 스트리핑	10~14AWG
추가시양 1.	조절노브 1개 조절노브 2개
추가시양 2.	TPR핸들
추가시양 3.	길이조절장치

SUNKEY 와이어 스트리퍼, Wire Stripper

TAIWAN



▲ SWS-0826

- 스프링 장착으로 작업속도 증가
- 특수 열처리로 뛰어난 내구성 피복을 깔끔하게 제거

<B3>

ORDER NO.	MODEL NO.	PRICE, ₩ Ea.	사용범위(mm)	포장단위 Ea. / Pk.
▶ 0488-018	SWS-0826	10,020	AWG : 20, 18, 16, 14, 12, 10 0.8, 1.0, 1.3, 1.6, 2.0, 2.6	1 / 6
0488-019	SWS-0413	10,020	AWG : 26, 24, 22, 20, 18, 16 0.4, 0.5, 0.6, 0.8, 1.0, 1.3	1 / 6
0488-020	SWS-0520	10,020	AWG : 24, 22, 20, 18, 16, 14, 12 0.5, 0.65, 0.8, 1.0, 1.3, 1.6, 2.0	1 / 6

, Cutters 커터/절단기

KDY 볼트클리퍼/커터, Bolt Clipper/Cutter, Grip ϕ 4~ ϕ 14mm

다국적



- 작업시 피로절감 손잡이
- 재질 : 고탄소강

<B3>

ORDER NO.	MODEL NO.	PRICE, ₩ Ea.	규격	절단능력(ϕ)	포장단위 Ea. / Pk.
0278-216	KBC-300	8,540	12"	4	
0278-217	KBC-350	9,720	14"	5	1 / 6
0278-218	KBC-450	11,870	18"	6	
0278-219	KBC-600	19,410	24"	8	1 / 6
0278-220	KBC-900	31,280	36"	12	1 / 5
0278-221	KBC-1050	52,840	42"	14	1 / 3

KDY 케이블 커터, Cable Cutter

TAIWAN



- 동, 알루미늄, 케이블 등 절단 가능

<B3>

ORDER NO.	MODEL NO.	PRICE, ₩ Ea.	규격	포장단위 Ea. / Pk.
0444-957	6141-06C	10,920	150(6")	1 / 6
0444-958	6141-08C	15,960	200(8")	1 / 6

KDY 라쳇 케이블 커터, Ratcheting Cable Cutter

TAIWAN



- 동선 및 알루미늄 커넥터 케이블 절단용
- 라쳇타입으로 손쉽게 절단 가능



<B3>

ORDER NO.	MODEL NO.	PRICE, ₩ Ea.	전장 (mm)	컷팅능력 mm ²	AMG	포장단위 Ea. / Pk.
0457-728	6AD10-325	97,440	255	325	600	1 / 10
0444-960	6AD10-3P01	25,200	-	325		1 / 100

Articles	Cat. No	Description
----------	---------	-------------

KDY 플라스틱 파이프커터, Plastic Pipe Cutter, Ex; PP, PTFE, PVC, etc. 다국적

(1) Standard Type, Grip max ϕ 36mm



- 최대별림 : 36mm
- 테프론 코팅
- 간편 잠금장치
- 알루미늄 바디로 경량화



<B3>

ORDER NO.	MODEL NO.	PRICE, ₩ Ea.	규격(mm)	포장단위 Ea. / Pk.
0477-514	KAP-200	4,710	200	1 / 10

(2) Ratchet Type, Grip max ϕ 42mm



- 최대별림 : 42mm
- 테프론 코팅 : 물체가 잘 달라붙지 않으며 저항이 적어 빠른 작업 가능
- 원터치 오픈 기능 : 터치 한번에 커터 리로드
- 라쳇 기능 : 세밀한 작업을 위한 라쳇기능
- 간편 잠금장치

ORDER NO.	MODEL NO.	PRICE, ₩ Ea.	규격(mm)	포장단위 Ea. / Pk.
0477-515	KVP-42	9,720	225	1 / 10

KDY PVC 파이프 커터, Ratchet-type Plastic Pipe Cutter TAIWAN

(1) 라쳇타입커터, 7913A-63



(1) Cutter



- 피로절감 TPR 핸들
- PVC, PP, PE, PEX, PB 튜브 절단가능

<B3>

ORDER NO.	MODEL NO.	PRICE, ₩ Ea.	사용범위(mm)	포장단위 Ea. / Pk.
0444-897	7913A-63	67,200	6~63	1 / 6

(2) 커터날, 7913A-724



(2) Spare Blade

ORDER NO.	MODEL NO.	PRICE, ₩ Ea.	포장단위 Ea. / Pk.
0457-724	7913A-6311	37,800	1 / 100

, Cutting Tools 절삭공구

YG 콤보 스파이럴 탭, Combo Spiral Tap KOREA

- 막힌 구멍 및 관통구멍 가공용으로 칩이 연속으로 발생하는 탄소강 및 합금강에 적합
- 내구성이 향상되었으며 고능률적인 나사 작업이 가능

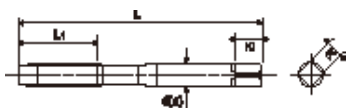

(1) 비호모 / 미리사이즈

단위 : mm <B3>

ORDER NO.	SIZE	(1) 비호모 PRICE, ₩	전장(L)	생크(d ϕ)	나사길이 (L1)
0251-189	M 3.0×0.5	5,340	46	4.0	11
0250-535	M 4.0×0.7	5,150	52	5.0	13
0250-536	M 5.0×0.8	5,250	60	5.5	16
0250-537	M 6.0×1.0	5,640	62	6.0	19
0251-192	M 8.0×1.25	7,610	70	6.2	22
0251-193	M 10.0×1.5	10,280	75	7.0	24
0251-194	M 12.0×1.75	14,220	82	8.5	29
0251-195	M 14.0×2.0	18,660	88	10.5	30
0250-776	M 16.0×2.0	23,010	95	12.5	32
0253-466	M 20.0×2.5	42,640	105	15	37

(2) 호모 / 미리사이즈

단위 : mm

ORDER NO.	SIZE	(2) 호모 PRICE, ₩	전장(L)	생크(d ϕ)	나사길이 (L1)
0252-026	M 3.0×0.5	5,640	46	4.0	11
0252-027	M 4.0×0.7	5,340	52	5.0	13
0252-028	M 5.0×0.8	5,540	60	5.5	16
0252-029	M 6.0×1.0	5,930	62	6.0	19
0252-030	M 8.0×1.25	8,000	70	6.2	22
0252-031	M 10.0×1.5	10,770	75	7.0	24
0251-172	M 12.0×1.75	14,910	82	8.5	29
0252-032	M 14.0×2.0	19,550	88	10.5	30
0250-777	M 16.0×2.0	24,100	95	12.5	32
0252-054	M 20.0×2.5	44,820	105	15	37



하이스올소, HSS Hole Saw

KOREA



- 두께 1.6mm 미만의 철판을 천공작업, 가격이 저렴하고, 파손율이 낮아서 보관이 용이
 - Drilling Machine 또는 핸드드릴에 부착하여 사용
 - 모든 창호작업 및 전기판넬, 자동차 등 다양한 업종에 적용하는 소모공구 사용
- 단위 : mm <B3>

ORDER NO.	SIZE	PRICE, ₩	ORDER NO.	SIZE	PRICE, ₩
0463-241	12		0463-253	24	
0463-242	13	3,050	0463-254	25	4,660
0463-243	14		0463-255	26	
0463-244	15	3,230	0463-256	27	5,290
0463-245	16		0463-257	28	
0463-246	17	3,230	0463-258	29	5,290
0463-247	18		0463-259	30	
0463-248	19	3,680	0463-260	31	
0463-249	20		0463-261	32	5,290
0463-250	21	4,040	0463-262	33	
0463-251	22	4,040	0463-263	34	
0463-252	23		0463-264	35	6,550

ORDER NO.	SIZE	PRICE, ₩	ORDER NO.	SIZE	PRICE, ₩
0463-265	36	6,550	0463-292	62	
0463-266	37		0463-293	63	15,860
0463-267	38	7,260	0463-294	64	
0463-268	39		0463-295	65	
0463-269	40	8,790	0463-296	66	17,750
0463-270	41		0463-297	67	
0463-272	42		0463-298	68	17,750
0463-273	43	8,790	0463-299	69	
0463-274	44		0463-300	70	
0463-275	45	10,760	0463-301	71	23,300
0463-276	46		0463-302	72	
0463-277	47		0463-305	75	23,300
0463-278	48	10,760	0463-306	76	
0463-279	49		0463-310	80	28,000
0463-280	50	11,650	0463-315	85	28,000
0463-281	51		0463-320	90	
0463-282	52		0463-325	95	37,370
0463-283	53	11,650	0463-330	100	
0463-284	54		0463-335	105	46,690
0463-285	55	13,000	0463-340	110	
0463-286	56		0463-346	115	56,000
0463-287	57		0463-351	120	
0463-288	58	13,000	0463-352	125	
0463-289	59		0463-354	130	
0463-290	60	15,860	0463-534	135	84,000
0463-291	61	15,860	0463-538	150	104,570



초경올소, Carbide Hole Saw

KOREA



- 두께 4mm 미만의 철판을 천공작업, 가격이 저렴
 - 창호, 전기판넬, 자동차 등 다양한 업종에 적합하며 Stainless, 동, 알루미늄, FRP 등 비철금속에도 사용 가능
- 단위 : mm <B3>

ORDER NO.	SIZE	PRICE, ₩	ORDER NO.	SIZE	PRICE, ₩
0463-355	13		0463-368	26	
0463-356	14		0463-369	27	
0463-357	15	6,280	0463-370	28	7,170
0463-358	16		0463-371	29	
0463-359	17		0463-372	30	
0463-360	18		0463-373	31	
0463-361	19	6,280	0463-374	32	8,070
0463-362	20		0463-375	33	
0463-363	21		0463-376	34	9,070
0463-364	22	7,170	0463-377	35	
0463-365	23		0463-378	36	
0463-366	24	7,170	0463-379	37	10,080
0463-367	25		0463-380	38	

ORDER NO.	SIZE	PRICE, ₩	ORDER NO.	SIZE	PRICE, ₩
0463-381	39		0463-418	75	
0463-382	40	10,080	0463-423	80	21,240
0463-383	41		0463-428	85	
0463-384	42	12,280	0463-433	90	32,260
0463-385	43		0463-434	91	36,290
0463-386	44		0463-435	92	
0463-387	45	12,280	0463-436	93	
0463-388	46		0463-437	94	36,290
0463-389	47	16,130	0463-438	95	
0463-390	48		0463-439	96	
0463-391	49		0463-440	97	
0463-392	50		0463-441	98	
0463-393	51	16,130	0463-442	99	36,290
0463-394	52		0463-443	100	
0463-395	53		0463-448	105	42,480
0463-396	54		0463-453	110	42,480
0463-397	55	16,130	0463-458	115	
0463-398	56		0463-463	120	48,570
0463-399	57	19,350	0463-464	125	
0463-400	58		0463-466	130	61,600
0463-401	59		0463-529	135	
0463-402	60	19,350	0463-530	140	82,620
0463-407	65		0463-531	145	
0463-412	70	21,240	0463-532	150	92,830

Articles Cat. No Description

EXP 초경 롱홀소, Carbide Long Hole Saw KOREA



- 두께 4mm 미만의 철판을 천공작업, 가격이 저렴
- 창호, 전기판넬, 자동차 등 다양한 업종에 적합하며 스테인리스, 동, 알루미늄, FRP 등 비철금속에도 사용 가능

단위 : mm <B3>

ORDER NO.	SIZE	PRICE, ₩	ORDER NO.	SIZE	PRICE, ₩
0513-210	13		0513-232	23	
0513-211	14		0513-233	24	13,870
0513-212	15	13,100	0513-234	25	
0513-213	16		0513-235	26	14,490
0513-214	17		0513-236	27	14,490
0513-215	18		0513-237	28	
0513-216	19	13,100	0513-238	29	14,490
0513-217	20	15,290	0513-239	30	
0513-230	21	13,870	0513-240	31	15,800
0513-231	22	13,870	0513-241	32	15,800

ORDER NO.	SIZE	PRICE, ₩	ORDER NO.	SIZE	PRICE, ₩
0513-242	33		0513-264	55	32,730
0513-243	34	17,410	0513-265	56	
0513-244	35		0513-266	57	
0513-245	36	21,260	0513-267	58	37,360
0513-246	37	21,260	0513-268	59	
0513-247	38		0513-269	60	
0513-248	39	21,260	0513-270	61	
0513-249	40		0513-271	62	37,360
0513-250	41	23,110	0513-272	63	
0513-251	42	23,110	0513-273	64	
0513-252	43		0513-274	65	37,360
0513-253	44	23,110	0513-279	70	41,210
0513-254	45	34,150	0513-289	75	48,520
0513-255	46		0513-294	80	64,210
0513-256	47	32,730	0513-302	85	64,210
0513-257	48		0513-307	90	61,600
0513-258	49		0513-313	95	
0513-259	50	32,730	0513-318	100	73,160
0513-260	51		0513-323	105	84,710
0513-261	52		0513-329	110	88,170
0513-262	53				
0513-263	54	32,730			

SUNKEY 하이스 브로치 커터, HSS Broach Cutter 다국적



- 프랑수산 하이스소재 사용
- 원터치 타입



<B3>

ORDER NO.	규격(mm)	PRICE, ₩ Ea.	가공깊이(mm)	포장단위 Ea. / Pk.
0446-109	12	34,590		
0446-110	13	34,590		
0446-111	14	34,590	25	
0446-112	15	34,590		
0446-113	16	34,590		
0446-114	17	36,400		
0446-115	18	38,230		
0446-116	19	39,140	25	
0446-117	20	41,870		1 / 10
0446-118	21	43,680		
0446-119	22	45,510		
0446-120	23	47,320		
0446-121	24	51,880	25	
0446-122	25	53,700		
0446-123	26	56,430		
0446-124	28	63,710	25	
0446-125	22	63,710	★55	

SUNKEY 초경 브로치 커터, Carbide Broach Cutter 다국적



- 독일산 초경팁 사용
- 원터치 타입
- 바디 : 일본산 소재 사용



<B3>

규격(mm)	35mm		50mm		포장단위 Ea. / Pk.
	ORDER NO.	PRICE, ₩ Ea.	ORDER NO.	PRICE, ₩ Ea.	
12	0456-155	59,160	-	-	
14	0445-228	59,160	0446-086	77,360	
16	0451-806	59,160	-	-	
17	0445-229	59,160	-	-	
18	0446-071	55,520	0446-087	68,260	
19	0446-072	55,520	0446-088	68,260	
20	0446-073	55,520	0446-089	68,260	
21	0446-074	56,430	-	-	
22	0446-075	59,160	0446-090	70,990	
23	0446-076	60,980	0446-092	72,800	
24	0446-077	60,980	0446-093	73,720	
25	0446-078	62,800	0446-094	77,360	
26	0446-079	63,710	0446-095	78,270	
27	0446-080	65,520	0446-096	79,180	
28	0446-081	67,350	0446-097	81,000	
30	0446-082	71,900	0446-099	87,360	
32	0446-083	75,540	0446-100	91,000	
33	0446-084	82,820	0446-101	94,640	

1 / 10

Articles

Cat. No

Description

EXP 육각 카운터 싱크 (90° 홀), Hex Counter Sink 90° Hole



- 6.35mm 육각타입으로 전동 체결 용이
- 플라스틱, 알루미늄 등 연강가공에 최적함

ORDER NO.	MODEL NO.	PRICE, ₩	사용범위(mm)	전장(mm)
0440-189	ECH-10	7,260	2~5	42
0440-182	ECH-15	11,370	5~10	51
0440-187	ECH-20	17,560	10~15	61
0440-188	ECH-25	28,820	15~20	81
0446-987	ECH-30	41,160	20~25	93

BANCO 하이스 톱날, HSS Bi-metal Hack Saw Blades 다국적



ORDER NO.	규격	PRICE, ₩ Ea.	포장단위 Ea. / Pk.
0210-320	M 300 (12")×18T	1,270	1 / 100
0129-205	M 300 (12")×24T	1,120	1 / 100

, Drills 드릴



2pcs Compact Awl Set, with stainless-steel Drill stem & PP Handle
Good for Drilling a small Hole in Paper/Plastic/Wood, 송곳 2종 세트

* Bit L75mm, Overall L165mm * with Sharp Tip
DH.Too8002 Awl Set/2pcs, L165mm, Drill 65mm

Set.	Price, ₩
	1,540

SUNKEY 자동 센터펀치, Auto Center Punch TAIWAN



- 금구기 용구의 일종
- 비트 최고급 합금강 S2 재질로 내구성이 우수
- 내부에 스프링이 장치되어 있어 손쉽게 마킹

ORDER NO.	MODEL NO.	규격	PRICE, ₩ Ea.	포장단위 Ea. / Pk.
0414-774	SOP-130	중	9,020	1 / 12
0414-775	SOP-160	대	10,660	1 / 12

, Drilling Tools 드릴공구

EXP 드릴링 머신, Drilling Machine



보호커버 장착으로 안전하게 작업가능
핸들을 돌려 높이조절가능
작업테이블 눈금각

- 비철 및 목재 가공 용이
- 콤팩트한 모터 채용으로 정속하며 강력한 힘
- 정밀하고 경제적으로 공업용 및 가정에서 DIY작업으로 사용 가능



제품사양 <B3>

스윙 (1/2) A	105mm	
컬럼직경	58mm	
테이블직경 B	160×160mm	
주축단과 테이블 최대거리 C	210mm	
주축단과 베이스 최대거리 D	295mm	
베이스	크기 E×F	290×190mm
	높이 G	43mm
기계높이 H	580mm	
주축의 테이블	JT6	
드릴능력	주철	1.5~13mm
	강	
주축상하이동거리	50mm	
전동기	350W	
중량	13.5kg	
주축회전수 (RPM)	740~3,140	

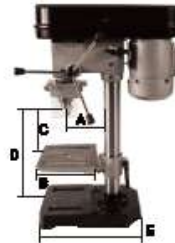

ORDER NO.	MODEL NO.	PRICE, ₩ Ea.	포장단위 Ea. / Pk.
0464-395	EDP-13	131,720	1

YSD 드릴링 머신, Drilling Machine KOREA

▶ YSDM-13

	YSDM-13	YSDM-19
드릴능력(강)	M2-M11	M2-M16
드릴능력(주물)	M2-M13	M2-M19
모터	삼성0.4kw 4P	
스핀들테이퍼	JT6	MT2
중량(kg)	60	65



ORDER NO.	MODEL NO.	전압(V)	PRICE, ₩
▶ 0221-063	YSDM-13	220	735,000
0221-062	YSDM-19	220	764,400

YST 탭핑 머신, Tapping Machine KOREA

▶ YSTM-13

	YSTM-13	YSTM-19
탭핑능력(강)	M3-M8	M3-M12
탭핑능력(주물)	M3-M10	M3-M14
모터	삼성 0.4KW 6P	
스핀들테이퍼	MT2	MT2
중량(kg)	80	85



ORDER NO.	MODEL NO.	전압(V)	PRICE, ₩
▶ 0195-241	YSTM-13	380	1,176,000
0210-803	YSTM-19	380	1,205,400

Articles Cat. No Description

드릴척, Drill Chuck KOREA



(1) 공작기계용



(2) 휴대전기용



(3) 나사체결용

(1) 공작기계용 <B3>

ORDER NO.	MODEL NO.	테이퍼형식	사용범위(mm)	PRICE, ₩
0103-294	4MG	JT #0	0.4~4.0	33,400
0103-282	13MG	JT6	1.0~13.0	28,240
0103-289	19MG	JT3	1.0~19.0	59,250

(2) 휴대전기용

ORDER NO.	MODEL NO.	테이퍼형식	사용범위(mm)	PRICE, ₩
0155-338	6.5EL	JT1	0~6.5	14,900
0155-339	10EL	JT2(short)	0~10.0	18,090
0155-340	13EL	JT6	0~13.0	22,350

(3) 나사체결용

ORDER NO.	MODEL NO.	테이퍼형식	사용범위(mm)	PRICE, ₩
0202-480	6.5SL	3/8-24UNF	0~6.5	17,030
0202-479	10SL	1/2-20UNF	0~10.0	21,280
0202-481	13SL	1/2-20UNF	0~13.0	25,540

드릴척 핸들, Drill Chuck Handle KOREA

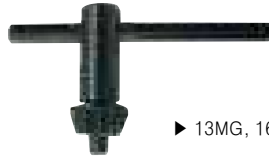

▶ 13MG, 16MG 공용

<B3>

ORDER NO.	MODEL NO.	PRICE, ₩	사용범위(mm)
0199-522	6.5, 10EL(SL) 공용	3,050	6.5, 10
0198-959	13EL (SL) 공용	3,100	13
0283-514	4MG	4,570	4
▶ 0191-837	13MG, 16MG 공용	4,570	13, 16
0296-108	19MG	6,090	19

키레스척, Keyless Chuck 다국적

▶ 13mm JT6



- CNC, 머신센터, 고성능 정밀기계에 적합
- 후크스패너 1개 무상제공

<B3>

ORDER NO.	MODEL NO.	사용범위(mm)	PRICE, ₩
▶ 0211-417	EDK-13S	1.0~13.0	51,560

목공드릴(오거비트), Auger Bit / Drill 다국적

- 각 끝날과 속날의 정밀한 가공으로 소음 최소화
- 각종 충전, 전기드릴, 드라이버에 사용 가능
- 앞쪽 나사타입으로 편하고 빠른 천공 가능



(1) Short-type



<B3>

ORDER NO.	MODEL NO.	PRICE, ₩ Ea.	규격(mm)	생크(mm)	포장단위 Ea. / Pk.
0421-137	EAB-6	2,380	6.0		1 / 50
0421-139	EAB-8	2,790	8.0		1 / 50
0421-140	EAB-9	2,890	9.0	6.35	1 / 25
0421-142	EAB-10	3,000	10.0		1 / 25
0421-143	EAB-11	3,100	11.0		1 / 25
0421-144	EAB-12	3,210	12.0	6.35	1 / 50
0421-146	EAB-13	3,450	13.0		1 / 50

ORDER NO.	MODEL NO.	PRICE, ₩ Ea.	규격(mm)	생크(mm)	포장단위 Ea. / Pk.
0421-148	EAB-14	3,680	14.0		1 / 25
0421-136	EAB-15	3,890	15.0		1 / 25
0421-149	EAB-16	4,100	16.0	6.35	1 / 25
0421-150	EAB-17	4,320	17.0		1 / 25
0421-151	EAB-18	4,540	18.0		1 / 25
0421-152	EAB-19	4,970	19.0		1 / 25
0421-153	EAB-20	5,180	20.0	6.35	1 / 25
0421-154	EAB-21	5,620	21.0		1 / 25
0421-155	EAB-22	5,830	22.0	9	1 / 25
0421-156	EAB-23	6,590	23.0		1 / 25
0421-157	EAB-24	7,130	24.0	9	1 / 25
0421-158	EAB-25	7,450	25.0		1 / 25

<Continued On Next Page>

<Continued From... 목공드릴(오거비트), Auger Bit / Drill>

(2) Long-type

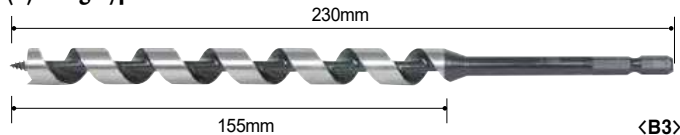

ORDER NO.	MODEL NO.	PRICE, ₩ Ea.	규격(mm)	샙크(mm)	포장단위 Ea. / Pk.
0421-159	EAB-6L	3,000	6.0		
0421-160	EAB-7L	3,000	7.0		
0421-161	EAB-8L	3,300	8.0	6.35	1 / 25
0421-162	EAB-9L	3,410	9.0		
0421-163	EAB-10L	3,510	10.0		
0421-164	EAB-11L	3,610	11.0	6.35	1 / 25
0421-165	EAB-12L	3,820	12.0		

ORDER NO.	MODEL NO.	PRICE, ₩ Ea.	규격(mm)	샙크(mm)	포장단위 Ea. / Pk.
0421-166	EAB-13L	4,100	13.0		
0421-167	EAB-14L	4,220	14.0	6.35	1 / 25
0421-168	EAB-15L	4,870	15.0		
0421-169	EAB-16L	4,970	16.0		
0421-170	EAB-17L	5,080	17.0		
0421-171	EAB-18L	5,290	18.0	6.35	1 / 25
0421-172	EAB-19L	5,730	19.0		
0421-173	EAB-20L	6,150	20.0		
0421-174	EAB-21L	6,800	21.0	6.35	
0421-175	EAB-22L	7,230	22.0		
0421-176	EAB-23L	7,670	23.0	9	1 / 12
0421-177	EAB-24L	8,630	24.0		
0421-178	EAB-25L	9,600	25.0		

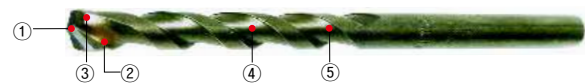

- ① HRC 70 고경도 제품 절삭가능(열처리된 제품 가공가능)
PGM 기준에 의해 만들어진 최고 품질의 콘크리트 드릴 팁 사용
- ② 임팩작업에 적합
- ③ 높은 온도의 구리용접으로 최대 섭씨 1,100℃까지 견딤
- ④ 플렉시블 크롬바나듐 샙크(Chrome Vanadium Shank)
- ⑤ 새로운 콘크리트 드릴 프루트(Flute) 디자인으로 칩배출과 먼지배출에 뛰어나

콘크리트 드릴/비트, Masonry Drill Bit

다국적



<B3>

ORDER NO.	MODEL NO.	규격(mm)	PRICE, ₩ Ea.	전장(mm)	포장단위 Ea. / Pk.
0266-754	ACD-3.0	3	1,180	70	
0266-755	ACD-3.5	3.5	1,180	75	
0266-756	ACD-4.0	4	1,180	80	1 / 10
0266-757	ACD-5.0	5	1,480	90	
0266-758	ACD-5.5	5.5	1,880	95	
0266-759	ACD-6.0	6	1,960	100	
0266-760	ACD-6.5	6.5	1,960	105	1 / 10
0276-614	ACD-7.0	7	2,170	110	

ORDER NO.	MODEL NO.	규격(mm)	PRICE, ₩ Ea.	전장(mm)	포장단위 Ea. / Pk.
0266-761	ACD-8.0	8	2,560	120	1 / 10
0266-762	ACD-9.0	9	3,050	130	1 / 10
0266-763	ACD-10.0	10	3,530	140	
0266-764	ACD-11.0	11	4,520	160	1 / 10
0266-765	ACD-12.0	12	4,620	160	
0266-766	ACD-13.0	13	6,480	200	1 / 10
0266-767	ACD-14.0	14	6,670	200	1 / 10

골드-피 드릴, Gold-P Drill

KOREA



■ 표면처리 : 포인트부 TiN코팅

ORDER NO.	SIZE (Dφ)	PRICE, ₩	날장 (L1)	전장 (L)
0196-935	M 1.5	1,300	23	48
0196-936	M 1.6	1,300	25	50
0196-937	M 1.7	1,300	25	50
0196-938	M 1.8	1,300	28	52
0196-939	M 1.9	1,300	28	52
0196-940	M 2.0	810	29	55
0196-941	M 2.1	810	29	55
0196-942	M 2.2	810	33	58
0196-943	M 2.3	810	33	58
0196-944	M 2.4	870	35	61
0196-945	M 2.5	870	35	61
0196-946	M 2.6	870	37	64
0196-947	M 2.7	870	37	64
0196-948	M 2.8	1,050	39	67
0196-949	M 2.9	1,050	42	71
0196-950	M 3.0	1,050	42	71
0196-951	M 3.1	1,050	42	71

ORDER NO.	SIZE (Dφ)	PRICE, ₩	날장 (L1)	전장 (L)
0196-952	M 3.2	1,160	42	71
0196-953	M 3.3	1,160	45	73
0196-954	M 3.4	1,160	45	73
0196-955	M 3.5	1,160	45	73
0196-956	M 3.6	1,300	48	76
0196-957	M 3.7	1,300	48	76
0196-958	M 3.8	1,300	48	76
0196-959	M 3.9	1,300	51	79
0196-960	M 4.0	1,470	54	83
0196-961	M 4.1	1,470	54	83
0196-962	M 4.2	1,470	54	83
0196-963	M 4.3	1,470	54	83
0196-964	M 4.4	1,710	56	86
0196-965	M 4.5	1,710	56	86
0196-966	M 4.6	1,710	56	86
0196-967	M 4.7	1,710	59	89
0196-968	M 4.8	1,920	59	89

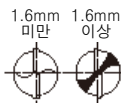

단위 : mm <B3>

ORDER NO.	SIZE (Dφ)	PRICE, ₩	날장 (L1)	전장 (L)
0196-969	M 4.9	1,920	62	92
0196-970	M 5.0	1,920	62	92
0196-971	M 5.1	1,920	62	92
0196-972	M 5.2	2,040	64	95
0196-973	M 5.3	2,040	64	95
0196-974	M 5.4	2,040	64	95
0196-975	M 5.5	2,040	64	95
0196-976	M 5.6	2,230	67	98
0196-977	M 5.7	2,230	67	98
0196-978	M 5.8	2,230	67	98
0196-979	M 5.9	2,230	67	98
0196-980	M 6.0	2,480	70	102
0196-981	M 6.1	2,480	70	102
0196-982	M 6.2	2,480	70	102
0196-983	M 6.3	2,480	70	102
0196-984	M 6.4	2,760	73	105
0196-985	M 6.5	2,760	73	105

Articles Cat. No Description

TG 코발트 드릴, Straight Shank Cobalt Drill KOREA

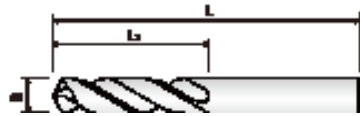

■ 표면처리 : 포인트부 TiN코팅

단위 : mm <B3>

ORDER NO.	SIZE (Dφ)	PRICE, ₩	날장 (L1)	전장 (L)
0001-281	M 1.5	1,990	23	48
0001-288	M 1.6	1,990	25	50
0001-295	M 1.7	1,990	25	50
0001-302	M 1.8	1,990	28	52
0001-309	M 1.9	1,990	28	52
0001-316	M 2.0	1,120	29	55
0001-323	M 2.1	1,120	29	55
0001-330	M 2.2	1,120	33	58
0001-337	M 2.3	1,120	33	58
0001-344	M 2.4	1,270	35	61
0001-352	M 2.5	1,270	35	61
0001-359	M 2.6	1,270	37	64
0001-367	M 2.7	1,270	37	64
0001-374	M 2.8	1,470	39	67
0001-381	M 2.9	1,470	42	71
0001-388	M 3.0	1,470	42	71

ORDER NO.	SIZE (Dφ)	PRICE, ₩	날장 (L1)	전장 (L)
0001-395	M 3.1	1,470	42	71
0001-402	M 3.2	1,720	42	71
0001-409	M 3.3	1,670	45	73
0001-416	M 3.4	1,720	45	73
0001-423	M 3.5	1,720	45	73
0001-430	M 3.6	1,940	48	76
0001-437	M 3.7	1,940	48	76
0001-444	M 3.8	1,940	48	76
0001-451	M 3.9	1,940	51	79
0001-458	M 4.0	2,260	54	83
0001-466	M 4.1	2,260	54	83
0001-473	M 4.2	2,260	54	83
0001-480	M 4.3	2,260	54	83
0001-487	M 4.4	2,580	56	86
0001-494	M 4.5	2,580	56	86
0001-502	M 4.6	2,580	56	86

ORDER NO.	SIZE (Dφ)	PRICE, ₩	날장 (L1)	전장 (L)
0001-509	M 4.7	2,580	59	89
0001-516	M 4.8	2,950	59	89
0001-523	M 4.9	2,950	62	92
0001-530	M 5.0	2,950	62	92
0001-538	M 5.1	2,950	62	92
0001-545	M 5.2	3,290	64	95
0001-552	M 5.3	3,290	64	95
0001-559	M 5.4	3,290	64	95
0001-566	M 5.5	3,290	64	95
0001-573	M 5.6	3,660	67	98
0001-580	M 5.7	3,660	67	98
0001-587	M 5.8	3,660	67	98
0001-594	M 5.9	3,660	67	98
0001-601	M 6.0	4,030	70	102

초경 강용 드릴, Solid Carbide High Hardened Drill KOREA

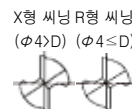
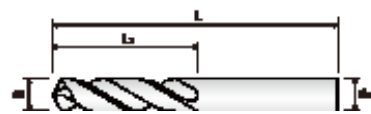

■ 신개발 드릴전용 WDI코팅을 적용

■ 칩배출 및 강성을 고려한 홈형상

단위 : mm <B3>

ORDER NO.	SIZE (Dφ)	PRICE, ₩	날장 (L1)	전장 (L)
0365-017	2.0	16,360		53
0365-018	2.1	16,360		53
0365-019	2.2	16,360	14	53
0365-020	2.3	16,360		53
0365-021	2.4	16,360		53
0365-022	2.5	16,360	14	53
0365-023	2.6	16,360		53
0365-025	2.7	16,360		53
0365-026	2.8	16,360	17	53
0365-027	2.9	16,360		53
0365-028	3.0	16,360	17	53
0365-029	3.1	16,360		58
0365-030	3.2	16,360		58
0365-031	3.3	16,360	20	58
0365-032	3.4	16,360		58
0365-033	3.5	16,360	20	58
0365-034	3.6	16,360		58
0365-035	3.7	16,360		58
0365-036	3.8	16,360	22	58
0365-037	3.9	16,360		58

ORDER NO.	SIZE (Dφ)	PRICE, ₩	날장 (L1)	전장 (L)
0365-038	4.0	16,360	22	58
0365-039	4.1	21,050		62
0365-040	4.2	21,050	24	62
0365-041	4.3	21,050		62
0365-044	4.4	21,050		62
0365-045	4.5	21,050	24	62
0365-046	4.6	21,050		62
0365-047	4.7	21,050	26	62
0365-048	4.8	21,050		62
0365-049	4.9	21,050		62
0365-050	5.0	21,050	26	62
0365-051	5.1	26,460		66
0365-054	5.2	26,460		66
0365-056	5.3	26,460	28	66
0365-057	5.4	26,460		66
0365-058	5.5	26,460		66
0365-059	5.6	26,460		66
0365-060	5.7	26,460	28	66
0365-061	5.8	26,460		66
0365-062	5.9	26,460		66

ORDER NO.	SIZE (Dφ)	PRICE, ₩	날장 (L1)	전장 (L)
0365-063	6.0	26,460	28	66
0365-064	6.1	33,460		74
0365-065	6.2	33,460		74
0365-066	6.3	33,460	34	74
0365-067	6.4	33,460		74
0365-068	6.5	33,460		74
0365-069	6.6	33,460		74
0365-070	6.7	33,460	34	74
0365-071	6.8	33,460		74
0365-072	6.9	33,460		74
0365-073	7.0	33,460		74
0365-074	7.1	36,020		74
0365-075	7.2	36,020	41	79
0365-076	7.3	36,020		79
0365-077	7.4	36,020		79
0365-078	7.5	36,020		79
0365-079	7.6	36,020		79
0365-080	7.7	36,020	41	79
0365-081	7.8	36,020		79
0365-082	7.9	36,020		79

<Continued On Next Page>

<Continued From... 초경 강용 드릴, Solid Carbide High Hardened Drill>

단위 : mm <B3>

ORDER NO.	SIZE (Dφ)	PRICE, ₩	날장 (L1)	전장 (L)
0365-083	8.0	36,020	41	79
0365-084	8.1	41,080		84
0365-085	8.2	41,080		84
0365-086	8.3	41,080	43	84
0365-087	8.4	41,080		84
0365-088	8.5	41,080		84
0365-089	8.6	41,080		84
0365-090	8.7	41,080	43	84
0365-091	8.8	41,080		84
0365-092	8.9	41,080		84
0365-093	9.0	41,080	43	84
0365-094	9.1	46,630		89
0365-096	9.2	46,630		89
0365-097	9.3	46,630	47	89
0365-098	9.4	46,630		89
0365-099	9.5	46,630		89
0365-100	9.6	46,630		89
0365-101	9.7	46,630	47	89
0365-102	9.8	46,630		89
0365-103	9.9	46,630		89
0365-104	10.0	46,630	47	89

ORDER NO.	SIZE (Dφ)	PRICE, ₩	날장 (L1)	전장 (L)
0365-105	10.1	54,350		95
0365-106	10.2	54,350		95
0365-107	10.3	54,350	55	95
0365-108	10.4	54,350		95
0365-109	10.5	54,350		95
0365-110	10.6	54,350		95
0365-111	10.7	54,350		95
0365-112	10.8	54,350	55	95
0365-113	10.9	54,350		95
0365-114	11.0	54,350		95
0365-115	11.1	63,410		102
0365-116	11.2	63,410		102
0365-117	11.3	63,410	55	102
0365-118	11.4	63,410		102
0365-119	11.5	63,410		102
0365-120	11.6	63,410		102
0365-121	11.7	63,410		102
0365-122	11.8	63,410	55	102
0365-123	11.9	63,410		102
0365-124	12.0	63,410		102
0365-125	12.1	81,480	60	107

ORDER NO.	SIZE (Dφ)	PRICE, ₩	날장 (L1)	전장 (L)
0365-126	12.2	81,480		107
0365-127	12.3	81,480		107
0365-128	12.4	81,480	60	107
0365-129	12.5	81,480		107
0365-130	12.6	81,480		107
0365-131	12.7	81,480		107
0365-134	13.0	81,480	60	107
0365-141	13.5	90,500		107
0365-146	14.0	90,500	62	107
0365-155	14.5	106,400	65	115
0365-158	15.0	106,400	65	115
0365-163	15.5	108,100		115
0365-168	16.0	108,100	68	115
0365-174	16.5	121,700		123
0365-180	17.0	121,700	73	123
0365-185	17.5	169,560		123
0365-189	18.0	169,560	73	123
0365-194	18.5	186,310		131
0365-199	19.0	186,310	79	131
0365-204	19.5	207,060		131
0365-209	20.0	207,060	79	131

HOUT 드릴 세트, Drill Set

U.S.A.



<B3>

ORDER NO.	규격	PRICE, ₩	구성품 SIZE
0013-644	13PCS	11,350	1.5, 2.0, 2.5, 3.0, 3.2, 3.5, 4.0, 4.5, 4.8, 5.0, 5.5, 6.0, 6.5
0013-650	19PCS	32,330	1.0, 1.5, 2.0, 2.5, 3.0, 3.5, 4.0, 4.5, 5.0, 5.5, 6.0, 6.5, 7.0, 7.5, 8.0, 8.5, 9.0, 9.5, 10.0
0013-657	25PCS	51,040	1.0, 1.5, 2.0, 2.5, 3.0, 3.5, 4.0, 4.5, 5.0, 5.5, 6.0, 6.5, 7.0, 7.5, 8.0, 8.5, 9.0, 9.5, 10.0, 10.5, 11.0, 11.5, 12.0, 12.5, 13.0

EXP 노스드릴 (골드타입), Reduced Shank Drill (Gold Type)

다국적

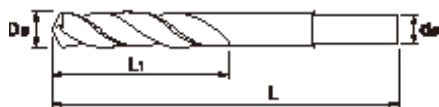

삼각형태 생크로 체결력 극대화

▶ 삼각형태 생크



단위 : mm <B3>

ORDER NO.	SIZE(Dφ)	PRICE, ₩	날장(L1)	전장(L)	생크직경(dφ)
0417-705	13.5	6,520			
0417-706	14.0	6,720			
0417-707	14.5	6,940	80	152	9.5
0417-708	15.0	7,560			
0417-709	15.5	8,090			
0417-710	16.0	8,200			
0417-711	16.5	8,520			
0417-712	17.0	8,930	80	152	9.5
0417-713	17.5	9,460			
0417-714	18.0	9,770			

ORDER NO.	SIZE(Dφ)	PRICE, ₩	날장(L1)	전장(L)	생크직경(dφ)
0417-715	18.5	10,080			
0417-716	19.0	10,610			
0417-717	19.5	11,140	80	152	9.5
0417-718	20.0	11,350			
0417-719	21.0	12,190			
0417-720	22.0	12,930			
0417-721	23.0	13,870			
0417-722	24.0	15,020	80	152	9.5
0417-723	25.0	16,080			

Articles Cat. No Description

EXP 노스드릴 세트 - 19 Pcs, Reduced Shank Drill Set



다국적

구성품 규격 (mm)				<B3>
13.5	14	14.5	15	
15.5	16	16.5	17	
17.5	18	18.5	19	
19.5	20	21	22	
23	24	25		

ORDER NO.	PRICE, ₩
0463-594	210,000

EXP NC드릴 세트 - 12 & 24 Pcs, NC Drill Set, 90° & 120°



KOREA

■ NC/CNC 장비에서의 가공구멍의 위치정도 향상을 위한 중심내기 가공, 면취가공에 적합!



▶ 90° 12PCS SET ▲ 90°, 120° 24PCS SET <B3>

ORDER NO.	SIZE(Dφ)	PRICE, ₩
▶ 0418-030	90° 12PCS SET (M3~M25)	222,070
▶ 0418-032	90°, 120° 24PCS SET (M3~M25)	444,130

EXP 스텝드릴 [전동드릴 사용], Step Drill, Use with Electric Drill

- 재질 : SKH51
- 다양한 크기의 구멍작업 가능

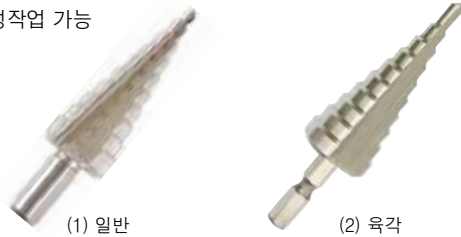

다국적

<B3>

ORDER NO.	MODEL NO.	PRICE, ₩ Ea.	사용범위 (mm)	생크직경 (dφ)	포장단위 Ea. / Pk.
(1) 0426-710	ESD-1	8,440	4~12	6	1 / 12
0426-711	ESD-2	9,610	4~12	6	1 / 12
0426-712	ESD-3	13,140	6~18	8	
0426-713	ESD-4	17,560	4~22	8	1 / 6
0426-714	ESD-5	44,890	5~35	10	
(2) 0421-659	ESD-1H	9,220	4~12		1 / 12
0421-657	ESD-2H	10,200	4~12		
0421-656	ESD-3H	14,610	6~18	육각	
0421-660	ESD-4H	19,810	4~22		1 / 6
0455-255	ESD-5H	48,220	5~35		

, Drivers 드라이버

KDY 전공 드라이버, Ball Grip Screwdriver

다국적



<B3>

⊕ ORDER NO.	MODEL NO.	PRICE, ₩ Ea.	규격(mm)	포장단위 Ea. / Pk.
0405-278	KSP-6100	2,170	6×100 ⊕	
0405-293	KSP-6150	2,270	6×150 ⊕	1 / 12
0405-294	KSP-6200	2,360	6×200 ⊕	
⊖ ORDER NO.	MODEL NO.	PRICE, ₩ Ea.	규격(mm)	포장단위 Ea. / Pk.
0405-295	KSS-6100	2,170	6×100 ⊖	
0405-296	KSS-6150	2,270	6×150 ⊖	1 / 12
0405-297	KSS-6200	2,360	6×200 ⊖	

KDY 전공 양용 드라이버, Ball Grip Reversible Screwdriver

다국적



<B3>

ORDER NO.	MODEL NO.	PRICE, ₩ Ea.	규격(mm)	포장단위 Ea. / Pk.
0405-299	KST-6100	2,660	6×100 ⊕⊖	
0405-300	KST-6150	2,950	6×150 ⊕⊖	1 / 12
0405-301	KST-6200	3,240	6×200 ⊕⊖	

KDY 투명 양용 드라이버, Crystal Reversible Screwdriver

다국적



<B3>

ORDER NO.	MODEL NO.	PRICE, ₩ Ea.	규격(mm)	포장단위 Ea. / Pk.
0405-280	KCT-638	1,090	6×38 ⊕⊖	1 / 24
0405-281	KCT-6100	1,770	6×100 ⊕⊖	
0405-282	KCT-6150	1,880	6×150 ⊕⊖	1 / 12
0405-277	KCT-6200	2,070	6×200 ⊕⊖	

KDY 길이조절 양용 드라이버, Adjustable Reversible Screwdriver 다국적



■ 5mm 단위씩 길이 조절 가능 ■ 전기, 전자, DIY용으로 적합 <B3>

ORDER NO.	MODEL NO.	PRICE, ₩ Ea.	규격(mm)	포장단위 Ea. / Pk.
0405-308	KAS-675	2,070	6×38~75⊕⊖	1 / 12

KDY 다가네드라이버, 망치사용가능, Go-Thru Screwdriver 다국적

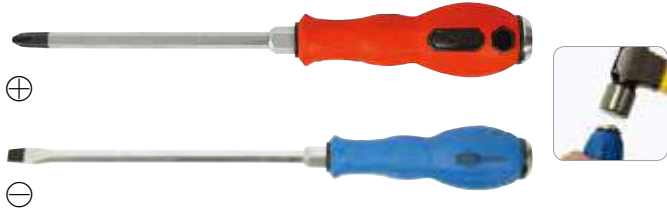

■ 드라이버 손잡이 끝부분까지 일체형으로 연결되어 망치로 사용 가능

<B3>

⊕ ORDER NO.	MODEL NO.	PRICE, ₩ Ea.	규격(mm)	포장단위 Ea. / Pk.
0405-302	KGP-8200	3,630	8×200⊕	1 / 6
0405-303	KGP-8250	3,920	8×250⊕	1 / 6
0405-313	KGP-10300	6,090	10×300⊕	1 / 6
0405-314	KGP-10350	6,870	10×350⊕	1 / 6

⊖ ORDER NO.	MODEL NO.	PRICE, ₩ Ea.	규격(mm)	포장단위 Ea. / Pk.
0405-305	KGS-8200	3,630	8×200⊖	1 / 6
0405-306	KGS-8250	3,920	8×250⊖	1 / 6
0405-315	KGS-10300	6,090	10×300⊖	1 / 6
0405-316	KGS-10350	6,870	10×350⊖	1 / 6

KDY 너트 드라이버, Nut Spinner TAIWAN



<B3>

ORDER NO.	MODEL NO.	PRICE, ₩ Ea.	규격(mm)	포장단위 Ea. / Pk.
0282-302	1450-05	5,780	5.0×125	
0282-303	1450-55	5,780	5.5×125	1 / 12
0282-304	1450-06	5,780	6.0×125	
0282-305	1450-07	6,310	7.0×125	
0282-306	1450-08	6,310	8.0×125	
0282-307	1450-09	6,310	9.0×125	1 / 12
0282-308	1450-10	6,310	10.0×125	
0282-309	1450-11	6,720	11.0×125	
0282-310	1450-12	6,720	12.0×125	1 / 12

VESSEL 고무 절연 드라이버, Rubber Grip Screwdriver JAPAN

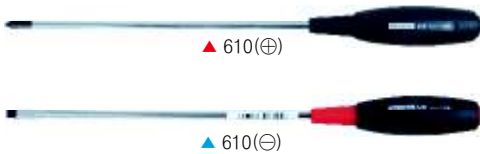

<B3>

⊕ ORDER NO.	⊖ ORDER NO.	MODEL NO.	규격 (mm)	PRICE, ₩ Ea.	두형	포장단위 Ea. / Pk.
▶ 0296-716	▶ 0296-717		4×75	4,510		
0296-718	0296-719	610	4×100	4,780	⊕ ⊖	1 / 12
0296-721	0296-720		4×150	5,040		

ANEX 핀서 드라이버, Pincer Driver JAPAN



<B3>

ORDER NO.	MODEL NO.	규격(mm)	PRICE, ₩ Ea.	포장단위 Ea. / Pk.
0388-826	9103	170	11,570	1 / 6

SUNKEY 시계용 정밀 드라이버 세트, Precision Screwdriver Set / 6Pcs TAIWAN



SPS-6H

- 손잡이 재질 : T P R (미끄럼방지 손잡이)
- 인체공학적 고무그립으로 작업 시 피로감소
- 카메라, 시계, 안경의 조립에 적합

SPS-6H 구성

- ⊕ PH0, PH00
- ⊖ 1.0 1.2 1.8 2.4

ORDER NO.	MODEL NO.	PRICE, ₩ Ea.	세트 수량	포장단위 Ea. / Pk.
▶ 0414-238	SPS-6H	8,380	6 PCS	1 / 20

Articles Cat. No Description

SUNKEY 라쳇 드라이버 세트, Ratchet Driver Set / 6Pcs

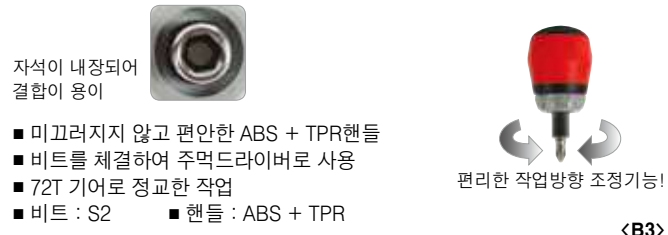
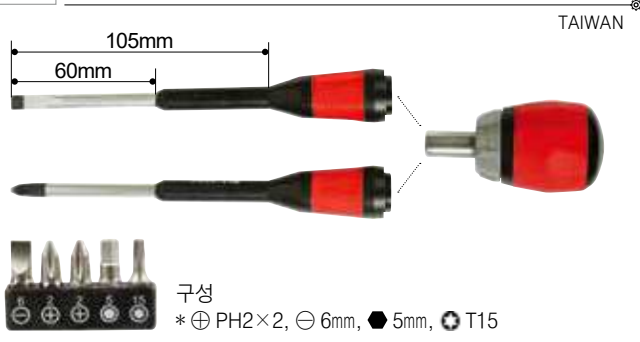

ORDER NO.	MODEL NO.	PRICE, ₩ Ea.	세트 수량	포장단위 Ea. / Pk.
0468-025	SRS-6S	15,290	6 PCS	1 / 10

SUNKEY 미니 라쳇 드라이버 세트, Mini Ratchet Driver Set



- 비트 교환용이, 좁은 공간 작업에 최적
 - 밴드 타입 (헤드 부분 16mm) ■ 15도 작업가능
- <B3>

ORDER NO.	MODEL NO.	PRICE, ₩ Ea.	세트 수량	포장단위 Ea. / Pk.
0402-945	SMR-9B	8,010	9 PCS	1 / 6



- S2재질 : 경도가 높아 내구성이 높음
- 니켈도금 : 녹이 잘 슬지 않는 니켈 표면처리
- 더블 비트형 PH2 + PH2 (위,아래 양쪽사용 가능)

SUNKEY 드라이버 비트, Driver Bit

ORDER NO.	MODEL NO.	PRICE, ₩ Ea.	전장(mm)	세트 수량	포장단위 Ea. / Pk.
0550-297	SMB-65	3,560	65	5 PCS	1 / 10
▶ 0550-299	SMB-110	4,560	110	5 PCS	1 / 5



SUNKEY 홀별비트 세트, Temper Torx Bit Set

ORDER NO.	MODEL NO.	PRICE, ₩ Ea.	전장(mm)	세트 수량	포장단위 Ea. / Pk.
0553-854	STB-775S	9,570	75	7 PCS	1 / 10

VESSEL 도금비트 드라이버, Screwdriver Silver Bit



ORDER NO.	MODEL NO.	규격(mm)	PRICE, ₩ Ea.	두형	포장단위 Ea. / Pk.
0477-320	BSG36	2×70	20,300	⊕	1 / 40
0482-998		2×100	23,730		1 / 25
0364-014		2×150	32,930		1 / 20
0460-462		2×200	49,020		1 / 15

VESSEL 엑스트라 핏 비트날, Extra Fit Silver Bit



ORDER NO.	MODEL NO.	규격(mm)	PRICE, ₩ Ea.	두형	포장단위 Ea. / Pk.
0361-784	SGM161065	1×65	7,730	⊕	1 / 10
0319-394	SGM162065	2×65	7,730		
▶ 0271-509	SGM162100	2×100	8,810		

Articles

Cat. No

Description



(1) Analog-type

Bosch® Analog & Digital Hot Air Gun, with Controller & Safety Device, 220V, 50/60Hz
With Attenuator, 50℃~630℃ Controlled, 150~500ℓ/min(wind Speed), 열풍건조기

* Button type : Convenient Handle with one Hand * Lightweight and Easy Design, with Safety Device
* Adjustable Heat & Air : up to 630℃(Heat), and up to 500ℓ/min(wind Speed)

(1) Analog-type, "GHG16-50", 300℃~500℃, 240~450ℓ/min(wind Speed)

* Two Step Control

0527-680 Heat Gun, 300~500℃, 520g, 240~450ℓ/min, 1,600w

Ea.	Price, ₩
	76,440

(2) Digital-type, "GHG20-63", 50℃~630℃, LCD Display, 150~500ℓ/min(wind Speed)

* Three Step Control

0527-681 Heat Gun, 50~630℃, 650g, 150~500ℓ/min, 2,000w

Ea.	Price, ₩
	141,120



(2) Digital-type



WORX INNOVATION 20V 충전 송풍기 (베어툴) 20V Cordless Jobsite Blower (Bare Tool) 20V POWER SHARPER

WX094.9

* 베어툴 : 충전기와 배터리를 포함하지 않는 제품 본체만 의미함

다국적

<B3>

주 문 번 호	0577-881	풍 속	260km/h
전 압	20V	풍 량	0~2.8m³/분
중 량	1.2kg	정 가	76,160
속 도 조 절	3단		

Optional Battery

0528-408 Battery, 20V, 2.5 Ah
0563-435 , 4.0 Ah

Ea.	Price, ₩
1ea	68,320
1ea	86,240



WORX INNOVATION 20V 충전 잎사귀 송풍기 Cordless Leaf Blower

20V POWER SHARPER

WG543E

다국적

<B3>

주 문 번 호	0579-831	풍 속	209km/h
전 압	20V	풍 량	696m³/h
중 량	1.7kg	송 풍 파 위	7.3N
배 터 리	4.0Ah(1pcs)	정 가	254,240



흡입기능추가



▲ ELB-26

EXP 엔진브로워, Engine Blower

다국적

- 리코일 스타트 적용으로 간편한 시동
- 강력한 팬으로 송풍기능 및 성능강화
- 편리한 스로틀레버

<B3>

주 문 번 호	0486-878	소 음	96dB
MODEL NO.	ELB-26	규 격	570×345×360mm
배 기 량	26.0cc	중 량	4.6kg
최 대 출 력	0.65kw	정 가	181,310
연 료 탱 크	0.6 ℓ		



WORX INNOVATION

충전 고압세척기 Cordless High Pressure Water Cleaner

20V POWER SHARPER

WG630E.2



BRUSHLESS MOTOR



red dot award 2017 winner

다국적

<B3>

주 문 번 호	0528-398	사 용 시 간	터보모드 13분 에코모드 18분
전 압	20V	정 력 토 출 량	210ℓ/시간
중 량	2.5kg	최 대 압 력	25bar
배 터 리	2.5Ah(1pcs)	정 가	256,480

Articles Cat. No Description

EXP 고압 물 세척기, High Pressure Water Cleaner, Electric Coded 다국적

(1) Midi-type



▲ EHP-120

공통

- 자흡기능 장착으로 고인 물을 스스로 흡입하여 물 공급
- 원터치 호스카플러가 내장되어 있어 편리한 호스장착 가능
- 원터치로 분리와 결합 용이

- 최대토출량 : 7.2 ℓ /min
- 호스길이 : 5M



(2) Standard-type



EHP-165 ▶

- 최대토출량 : 7.2 ℓ /min
- 호스길이 : 8M



ORDER NO.	MODEL NO.	PRICE, ₩	규격(mm)	소비전력(W)	최대압력(Bar)	중량(kg)
▶ 0515-355	EHP-120	135,240	336×329×277	1,500	120	7.5
▶ 0463-731	EHP-165	245,000	365×350×790	2,100	165	18

+ 산업용 진공 청소기 (3모터), 104Lit, Industrial Vacuum Cleaner, 3 Motor, Dry & Wet KOREA

C TYPE-φ45



- 104 Lit
- 규격 : 650×720×1,100mm
- 재질 : 스테인리스
- 진공도 : 2,700mmHzO
- Dry & Wet-type
- 중량 : 47kg
- 전압 : 220V/60Hz
- 코드선종류 : 25A13M3P(연질)

<B3>

ORDER NO.	MODEL NO.	PRICE, ₩	타입	용량 (ℓ)	소비전력 (W)
0236-717	SUPER-1000	990,640	건/습식	104	4,050

Articles

Cat. No

Description



WORX PROFESSIONAL 충전 해머드릴, 12V Cordless Hammer Drill **12V MAX POWER SHARPER**

WU131



BRUSHLESS MOTOR

다국적

<B3>

주 문 번 호	0565-406
전 압	12V
중 량	0.95kg
배 터 리	2.0Ah(2pcs)
무부하 회전수	1,800rpm
타 격 수	27,000bpm

토 크 최 대	30N.m
척 크 기	10mm
작 업 능 력	철재 10mm 목재 30mm
정 가	181,440



WORX INNOVATION 충전 해머드릴, 20V Cordless Hammer Drill **20V MAX POWER SHARPER**

WX352



BRUSHLESS MOTOR

다국적

<B3>

주 문 번 호	0585-922
전 압	20V
중 량	1.58kg
배 터 리	2.0Ah(2pcs)
무부하 회전수	0~2,000rpm
척 크 기	13mm

타 격 륜	9,000 ~32,000bpm
토 크 조 절	22+1+1
최 대 토 크	60N.m
정 가	240,800



Kress 해머드릴, Electric Hammer Drill

다국적

KU320P

<B3>

주 문 번 호	0579-832
전 압	850W
중 량	2.8kg
무부하 회전수	0~1,300rpm
타 격 륜	0~5,500bpm

임 팩 에 너 지	3.0J
모 드	드릴링, 해머링, 파쇄
사 용 비 트	SDS PLUS
드 릴 링 능 력	콘크리트 26mm
정 가	138,880



WORX PROFESSIONAL 해머드릴, Electric Hammer Drill

20V MAX POWER SHARPER

WU326P



reddot award 2017 winner

다국적

<B3>

주 문 번 호	0528-372
소 비 전 력	1,010W
중 량	3.9kg
정 격 타 격 륜	0~4,750bpm
임 팩 에 너 지	5.0J

모 드	해머링, 파쇄
사 용 비 트	SDS PLUS
최 대 드 릴 링	콘크리트 26mm
정 가	221,760



WORX INNOVATION 임팩드릴, Electric Impact Drill

다국적

WX317

<B3>

주 문 번 호	0528-411
전 압	600W
중 량	1.6kg
척 크 기	1.5~13mm
척 종 류	키레스척

무부하속도 타격률	0~48,000rpm
작 업 능 력	콘크리트 16mm 철재 12mm 목재 25mm
정 가	78,400

Articles	Cat. No	Description
----------	---------	-------------



임팩드릴세트, Electric Impact Drill Set

다국적

WX317.3

- 세트 구성품 : 커터칼, 망치, 절연 테이프, 실용 부품 키트, 드라이버, 몽키 스패너, 3미터 줄자, 진동 드릴, 손잡이, 수평기, 목공 드릴 (3/4/5/6/7/8mm), 하이스 드릴 (2/2.5/3/4/5/6/7/8/10mm), 펀치, 타일 드릴, 목공 톱 다용도 비트 (PH1/PH2/PH2.5/PH3/S6/S7/H5/H6/T15/T20)

<B3>

주 문 번 호	0528-412	작 업 능 력	콘크리트 16mm 철재 12mm 목재 25mm
전 압	600W	액 세 서 리	112pcs
중 량	1.6kg	정 가	110,880
척 크 기	1.5~13mm		
척 종 류	드릴척		



충전 스크류드라이버, 4V Cordless Screw Driver

4V^{MAX}

다국적

- 혁신적인 디자인으로 편리한 사용성
- 스크류 홀더 최대 5cm 조절 가능하여 좁은 공간 사용 최적화
- DIY 가구조립 및 자전거 수리 등 적합
- 세련되고 더욱 선명해진 LED 파워 라이트

WX262

충전시간 : 5시간 비트 사이즈 : 6.35mm



<B3>

주 문 번 호	0528-393	무부하 회전수	230rpm
전 압	4V	최 대 토 크	3N.m
중 량	0.5kg	액 세 서 리	10pcs
배 터 리	1.5Ah(내장형)	정 가	47,040



권총형 충전 스크류드라이버, 4V Cordless Screw Driver, Pistol-type

20V^{MAX} POWER SHAR[®]

다국적

WX255

- 권총형 타입 혁신적인 디자인으로 편리함
- 6개 다양한 비트가 장착되어 작업 효율증대
- 쉽고빠른 비트교체로 작업시간 단축
- 세련되고 더욱 선명해진 LED 파워 라이트

충전시간 : 3~5시간 비트 사이즈 : 6.35rpm

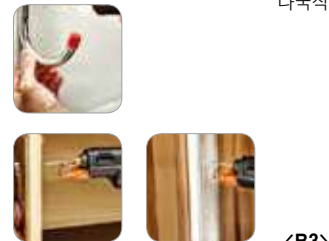

<B3>

주 문 번 호	0528-394	무부하 회전수	20rpm
전 압	4V	최 대 토 크	3N.m
중 량	0.5kg	액 세 서 리	6pcs
배 터 리	1.5Ah(내장형)	정 가	60,480



충전 드릴드라이버, 12V Cordless Drill Driver

12V^{MAX} POWER SHAR[®]

다국적

WU130



주 문 번 호	0528-384	토 크 최 대	30N.m
전 압	12V	척 크 기	10mm
중 량	0.9kg	작 업 능 력	철재 10mm 목재 20mm
배 터 리	2.0Ah(2pcs)	정 가	165,760
무부하 회전수	1,800rpm		

<B3>

Articles

Cat. No

Description



WORX INNOVATION 충전 드릴드라이버, 20V Cordless Drill Driver **20V POWER SHAR**

WX102



BRUSHLESS MOTOR

다국적

<B3>

주 문 번 호	0585-921	척 크 기	13mm
전 압	20V	토 크 조 절	18+1
중 량	1.55kg	최 대 토 크	60N.m
배 터 리	2.0Ah(2pcs)	정 가	239,680
무부하 회전수	0~2,000rpm		



BOSCH 충전 드릴드라이버, Cordless Drill Driver

다국적

- 토르크 최대 (강성/연성 재질): 30Nm/13Nm
- 토르크 세팅 : 20+1
- 척 크기 : 1~10mm
- 작업 능력 : 목재 19mm, 철재 10mm, 스크류 7mm

<B3>

주 문 번 호	0351-730	배 터 리 수 량	2ea
MODEL NO.	GSR10.8-2-LI	회 전 수	0~350/0~1,300rpm
전 압	10.8V	중 량	0.9kg
전 류	2.0Ah	정 가	257,880



WORX PROFESSIONAL 충전 임팩드라이버, 12V Cordless Impact Driver **12V POWER SHAR**

WU132



BRUSHLESS MOTOR

다국적

<B3>

주 문 번 호	0585-895	무부하 회전수	0~3,300rpm
전 압	12V	토 크 최 대	140N.m
중 량	0.95kg	분 당 타 격 수	4,000ipm
배 터 리	2.0Ah(2pcs)	정 가	179,200



WORX INNOVATION 충전 임팩드라이버, 20V Cordless Impact Driver **20V POWER SHAR**

WX262



BRUSHLESS MOTOR

다국적

<B3>

주 문 번 호	0572-719	무부하 회전수	0~3,000rpm
전 압	20V	분 당 타 격 수	4,000ipm
중 량	1.5kg	최 대 토 크	260N.m
배 터 리	2.0Ah(2pcs)	정 가	230,720



BOSCH 충전 임팩드라이버, Cordless Impact Driver

다국적

- 토르크 최대 (강성 재질) : 105Nm
- 정격 타격률 : 0~3,100bpm
- 비트 홀더 : 1/4" (6.35mm)
- 작업 능력 : M4-M12

<B3>

주 문 번 호	0351-732	배 터 리 수 량	2ea
MODEL NO.	GDR10.8V-LI	회 전 수	0~2,600rpm
전 압	10.8V	중 량	0.9kg
전 류	2.0Ah	정 가	228,480



BOSCH 충전 임팩 드릴 드라이버, Cordless Impact Drill Driver

다국적

- 토르크 최대 (강성/연성 재질): 30Nm/13Nm
- 토르크 세팅 : 20+1
- 척 크기 : 1~10mm
- 작업 능력 : 목재 19mm, 철재 10mm, 석재 10mm, 스크류 7mm

<B3>

주 문 번 호	0351-731	배 터 리 수 량	2ea
MODEL NO.	GSB10.8-2LI	회 전 수	0~380/0~1,300rpm
전 압	10.8V	중 량	1.0kg
전 류	2.0Ah	정 가	283,080

Articles	Cat. No	Description
----------	---------	-------------

STANLEY 충전 콤보 키트, Cordless Combo Full Set of Drill Driver & Impact Driver 다국적 <B3>

ORDER NO.	MODEL NO.	PRICE, ₩	전압(V)	전류(Ah)	회전수(rpm)	
					임팩	드릴
▶ 0466-370	SCD12S2-KR	201,940	10.8	1.5	2,500	1,500

▶ SCD12S2-KR



SCD12S2-KR

무부하 회전수	임팩	2,500rpm
	드릴	1,500rpm
토크 최대	임팩	110Nm
	드릴	26Nm
비트 홀더	1/4"(6.35mm)	
척 크기	10mm	
구성	10.8V SCD12S2K 임팩 드라이버	
	10.8V SCD12S2K 드릴 드라이버	
	10.8V 1.5Ah 배터리×2, 10.8V 충전기, 소프트백	



충전 글루건, 4V Cordless Glue Gun

4V

WX890

다국적 <B3>

주 문 번 호	0585-917	가 열 시 간	15초
전 압	4V	글 루 스 틱	7mm
중 량	0.3kg	접 착 온 도	160도
배 터 리	2.0Ah(내장형)	액 세 서 리	6pcs
총 전 타 입	C타입	정 가	47,040



충전 그라인더/커터, 휠 3종 포함

20V Cordless Disc Grinder/Cutter **20V POWER SHARPER**

다국적

WX801

- 빠르고 손쉬운 절단작업
- 한손으로 작업가능한 콤팩트한 사이즈
- 타일, PVC 파이프등 다양한 제품 절단가능
- 절단작업에 최적화된 인체공학적 디자인

<B3>



주 문 번 호	0528-388
전 압	20V
중 량	0.7kg
배 터 리	2.0Ah(1pcs)
무부하 회전수	19,500rpm
디스크 사이즈	3" (76mm)
액 세 서 리	4pcs
정 가	190,400



(1) Cutting Disc, 절단석 (WA6076.3)

- 철재 및 스테인리스 전용 절단석
- 외경 : 3" (76mm), 내경 : 9.5mm



(2) Diamond Cutting Disc, 다이아몬드 절단석 (WA6075)

- 석재/콘크리트 전용
- 외경 : 3" (76mm), 내경 : 9.5mm



(3) Depressed Center Wheel, 옴세트/연마석 (WA6074)

- 금형류의 세밀한 가공 작업에 최적
- 외경 : 3" (76mm), 내경 : 9.5mm

※ The Details : See the "Tools, Electronic Tools - Accessories" Section!



충전 그라인더, 20V Cordless Disc Grinder **20V POWER SHARPER**

다국적

WU808.5



BRUSHLESS MOTOR

<B3>

주 문 번 호	0606-380	모 드	3단계 속도조정
전 압	20V	휠 직 경	100mm(4")
중 량	2.0kg	스 핀 들 나 사	M10
배 터 리	4.0Ah(2pcs)	정 가	337,760
무부하 회전수	0~8,500rpm		

Articles

Cat. No

Description



배터리, Battery

다국적



WA3016	<B3>
주 문 번 호	0578-096
전 압	20V
배 터 리	4.0Ah
정 가	107,520

*20V 배터리는 크레스와 호환가능 (오렌지 워스 호환불가)



충전기, Charger

다국적



WA3924	<B3>
주 문 번 호	0585-916
전 압	20V
충 전 시 간	2.0Ah (60분)
	4.0Ah (120분)
	5.0Ah (150분)
	6.0Ah (180분)
정 가	30,240



손잡이 지름 : 169mm



전기 그라인더, Disc Grinder

다국적

WU810.1

<B3>

주 문 번 호	0585-911	휠 직 경	100mm(4")
전 압	750W	디 스크 보 어	15mm, 16mm
중 량	1.4kg	스 핀 들 나 사	M10
무 부 하 회 전 수	0~12,000rpm	정 가	61,600
전 원 스 위 치	후면 토크 스위치		



충전 다기능 샌더, 20V Cordless Multi Sander

다국적 **20V POWER SHARER**

WX820

<B3>

주 문 번 호	0548-760	사 용 시 간	저속 40~50분 고속 20~25분
전 압	20V	샌 디ング 패 드	원형, 삼각, 사각, 모서리, 틈새
중 량	2.0kg	사 이 즈	303×93×146mm
배 터 리	2.0Ah(1pcs)	정 가	190,400
무 부 하 회 전 수	4,000~10,000 rpm		
속 도 조 절	1~5단		



3M® Orbital Air Sanders, Provide Constant Abrasive Power, Durable, RPM Max. 12,000
Ideal for Sanding in Tight Areas or on Vertical Surface, Using with Air Compressor, **오비탈 샌더, 자가흡입식**

■ 목재, 페인트, 금속 가공 등 다용도 샌딩 작업용 ■ 흡입 시스템 및 크기는 동일, 용량이 2배 커진 필터백 적용

* 100% Compatible with 3M Sanding Disc * Components - Filter Bag, Adapter, Hose

* Gas Flow Rate 175CFM * Motor 0.28HP * Maximum RPM 12,000 * Diameter : 5"

<B4>

3M.08.1048 Orbital Sanders, 5 Inch, od ϕ 127×h84.5×L156mm, 0.83kg

Ea.	Price, ₩
	244,720



전기샌더, Electric Corded Sander

다국적

(1) 4각 샌딩 Plate형, 190W, 1.4kg

<B3>

주 문 번 호	0219-348	샌 디ング Pl ate	92×182mm
모 델 번 호	GSS230	샌 디ング 페 이 퍼	93×230mm
전 압	190W	진 동 회 로 직 경	2mm
중 량	1.4kg	정 가	86,520
무 부 하 진 동 수	24,000rpm		

(2) 원형 샌딩 Plate형, 250W, 1.3kg

주 문 번 호	0250-342	샌 디ング Pl ate	ϕ 125mm
모 델 번 호	GEX125-1AE	샌 디ング 시 트 / 디 스크 부 착	벨크로형
전 압	250W	진 동 회 로 직 경	2.5mm
중 량	1.3kg	정 가	137,760
무 부 하 진 동 수	15,000~24,000rpm		



Articles	Cat. No	Description
	3M.08.1049	3M® Air Belt Sanders, Multipurpose Sanding Work, Compact Size, Ideal for Light Sanding Work Powerful Grinding Power, Using with Air Compressor, 벨트 샌더, 컴팩트형 ■ 목재, 페인트, 금속 가공 등 다용도 샌딩 작업용 ■ 정비사가 접근하기 어려운 부위에 접근할 수 있도록 해 주며, 스폿 용접 제거, 디버링, 청소 및 마감 작업에 매우 적합 * Belt Speed : 4100 SFPM (1250 SMPM) * Max RPM : 17,000 * Weight : 0.94kg * Dimension : w73×L320mm * Motor HP : 485W * Belt Size : 10×330mm * Motor (0.28 horsepower)
		<B4>
		Ea. Price, ₩
		112,000

EXP 탁상 그라인더 & 벨트 샌더, Bench Grinder & Belt Sander



다국적

■ 불꽃 톱 방지를 위한 안전커버 장착 ▲ 탁상 그라인더 ▲ 벨트 샌더

ORDER NO.	품명	MODEL NO.	규격 (HP)	PRICE, ₩	휠 규격 (mm)	출력 (W)	회전수 (rpm)	벨트규격 (mm)	벨트속도 (M/S)	축경 (mm)
▶ 0246-798	탁상그라인더	TLG-125	1/8	58,800	125×16	200	3,450	-	-	12.74
0332-373		TLG-150N	1/4	78,400	150×25	300				15.88
▶ 0246-799	벨트샌더	TLG-150S	1/4	101,920	150×20	370	3,450	50×686	18	15.88

<B3>



WORX INNOVATION 중전 킷쏘, 20V Cordless Reciprocating Saw

다국적 **20V POWER SHAR**

WX500

<B3>

주문 번호	0577-031	스트로크길이	20mm
전압	20V	절단 깊이	목재 170mm 철재 12mm PVC 76mm
중량	2.37kg	정가	217,280
배터리	2.0Ah(1pcs)		
무부하 회전수	3,000rpm		



WORX INNOVATION 중전 직·킷쏘, 20V Cordless Multi Saw

다국적 **20V POWER SHAR**

WX550

<B3>

주문 번호	0528-386	무부하 회전수	3,000rpm
전압	20V	기능	오비탈기능
중량	1.5kg	액세서리	4pcs
배터리	2.0Ah(1pcs)	정가	257,600

WORX INNOVATION 킷소톱날, Cutsaw Blade



다국적

WA8010.3

<B3>

주문 번호	0576-365
용도	목공용
수량	3pcs
정가	5,490

WORX INNOVATION 직소톱날, Jigsaw Blade



다국적

WA8106

<B3>

주문 번호	0576-364
수량	10pcs
정가	13,670

Articles

Cat. No

Description

WORX INNOVATION 충전 체인톱(베어툴), Cordless Chainsaw **20V POWER SHAR**

다국적

* 베어툴 : 충전기와 배터리를 포함하지 않는 제품 본체만 의미함 <B3>



WG385E

20V×2EA 장착

주 문 번 호	0585-939
전 압	40V(20V×2EA 장착)
중 량	4.2kg (배터리 제외)
배 터 리	4.0Ah(2pcs)

가이드바 길이	400mm(16")
체 인 속 도	18m/s
체 인 규 격	90×28
정 가	282,240

	Ea.	Price, ₩
Spare; 0349-126 OREGON™ Chain Saw Blade "OR 90-28T"	1ea	18,730
Optional; 0563-435 Battery, 20V, 4.0 Ah	1ea	86,240

WORX INNOVATION 충전 체인톱, 20V Cordless Jawsaw **20V POWER SHAR**

다국적

<B3>



WG329E

체인톱날

주 문 번 호	0568-550
전 압	20V
중 량	3.5kg
배 터 리	2.0Ah(1pcs)
무부하 회전수	1,350rpm

절 단 능 력	최대 100mm
가이드바 규격	6" (150mm)
체 인 규 격	6.4mm(1/4")
체 인 속 도	2.54m/s
정 가	294,560

Spare Accessories

	Ea.	Price, ₩
0576-371 Chain Saw Blade, "WA0161(1/4)"	1ea	12,880

HONDA 예초기 (4행정 예초기), Brush Cutter KOREA



JP-35 E

4행정 : 가솔린 전용

- 엔진 HONDA 4행정 (국내 조립)
- 시동방식 : 리코일스타터
- 점화 방식 : 트랜지스터 마그네틱 전자점화방식
- 카브레이터 : 다이어그램방식
- 4사이클 오일 : 휘발유 따로 사용
- 국내소프트, 일제기어케이스

<B3>

주 문 번 호	0471-936
엔 진	GX35
중 량	9kg
사 프 트	2단분리형

배 기 량	35.8CC
회 전 수	7,000
연 료 탱 크	0.65 L
정 가	385,150

WORX INNOVATION 충전 예초기, 20V Cordless Brush Cutter **20V POWER SHAR**

다국적



WG163E.2

<B3>

주 문 번 호	0568-559
전 압	20V
중 량	2.4kg
배 터 리	2.0Ah(1pcs)

절 단 직 경	30cm
날 길 이	3m
날 직 경	1.65mm
정 가	191,520

EXP 각도 절단기/톱, Miter Saw

다국적

생산물배상책임보험 3억원 보험가입



- 목공, 알루미늄 등 다양한 톱날 사용 가능
- 헤드 0°~45° 각도 조절
- 10" (255mm) 목재용 톱날 포함
- 중량 : 15kg
- 절단능력 : 0° : 70mm / 90° : 150mm



▲ 안전보호장치



▲ 각도조정레버



▲ 다각도에서 컷팅

<B3>

ORDER NO.	MODEL NO.	PRICE, ₩	날 직경	소비전력 (W)	회전수 (rpm)	전원
0449-514	EMS-255	176,400	10"(255mm)	1,800	4,800	220-60Hz

Articles	Cat. No	Description
----------	---------	-------------

EXP 슬라이딩 각도 절단기/톱, Glide Miter Saw 다국적



- 정확한 절단을 위한 레이저 포인트 장착
- 헤드 0°~45° 각도 조절
- 10"(255mm) 목재용 톱날 포함
- 중량 : 18kg
- 절단능력 : 0° : 75mm / 90° : 305mm



▲ 안전보호장치 ▲ 각도조정레버 ▲ 다각도에서 컷팅

ORDER NO.	MODEL NO.	PRICE, ₩	날 직경	소비전력 (W)	회전수 (rpm)	전원
0449-515	EMS-255S	220,510	10"(255mm)	1,800	4,800	220-60Hz



Kress 충전 임팩렌치, Cordless Impact Wrench **20V POWER SHAR** 다국적

KU270



BRUSHLESS MOTOR

- 과전류, 고온, 모터 보호기능
- AUTO-STOP 기능 탑재
- 배터리 보호 기능 및 정속 제어
- 충전시간 : 125분

주 문 번 호	0528-414	분 당 타 격 수	0~3,200bpm
전 압	20V	최 대 토 토크	300N.m
중 량	1.7kg	척 크 기	12.7mm (1/2")
배 터 리	4.0Ah(2pcs)	정 가	250,880
무부하회전수	0~2,200rpm		

Kress 배터리, Battery ※20V 배터리 WORX PRO (그린)과 호환가능, ORANGE WORX 호환불가 다국적 <B3>



KPB2004	
주 문 번 호	0578-098
전 압	20V
배 터 리	4.0Ah
정 가	103,040

Kress 충전기, Charger 다국적 <B3>



KCH2006	
주 문 번 호	0578-099
전 압	20V
총 전 시 간	2.0Ah (60분) 4.0Ah (120분)
정 가	35,840

WORX INNOVATION 배터리, Battery ▶ 20V 오렌지 배터리는 WORX PRO(그린) 크레스와 호환 불가 다국적



▶ 12V용은 "웍스" Orange/Green 및 Kress와 호환!

12V

<B3>



WA3551	
주 문 번 호	0528-407
전 압	20V
배 터 리	2.0Ah
정 가	58,240



WA3572	
주 문 번 호	0528-408
전 압	20V
배 터 리	2.5Ah
정 가	68,320



WA3553	
주 문 번 호	0563-435
전 압	20V
배 터 리	4.0Ah
정 가	86,240

WORX INNOVATION 충전기, Charger 다국적



(1) 12V 공용 <B3>

WA3768	
주 문 번 호	0586-030
전 압	12V
총 전 시 간	2.0Ah (80분)
정 가	17,920



(2) 20V 급속충전기

WA3867	
주 문 번 호	0573-954
전 압	20V
총 전 시 간	2.0Ah (20분) 2.5Ah (25분) 4.0Ah (40분) 5.0Ah (50분)
정 가	62,720

Articles

Cat. No

Description



인버터 발전기, 직류를 교류로!, Inverter Generator, DC⇒AC

다국적

- ▶ USB 단자 장착으로 전자기기 충전 편리
- ▶ 시거잭 장착으로 차량용품 이용 가능
- ▶ 추가 스파크 플러그 포함



(1) 0.8 kW Outout "EGI-1000"

- 최대출력 : 0.8KW
- 정격출력 : 0.7KW
- 배기량 : 40cc
- 연료탱크 : 2.1 l
- 중량 : 9.3kg
- 연속사용가능시간 : 4.1H
- 소음 : 56dB
- 규격 : 395×221×345mm

<B3>

ORDER NO.	MODEL NO.	PRICE, ₩	최대출력(Kw)
▶ 0484-129	EGI-1000	490,000	0.8



(2) 2.2 kW Outout "EGI-2500"

- 최대출력 : 2.2KW
- 정격출력 : 2.0KW
- 배기량 : 114cc
- 연료탱크 : 4.0 l
- 중량 : 19kg
- 연속사용가능시간 : 3.5H
- 소음 : 58dB
- 규격 : 525×282×440mm

(2) EGI-2500

ORDER NO.	MODEL NO.	PRICE, ₩	최대출력(Kw)
▶ 0484-130	EGI-2500	833,000	2.2



콘크리트 드릴/비트, Masonry Drill Bit

다국적

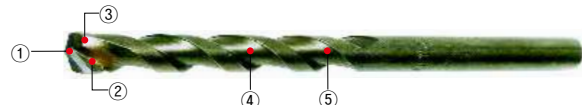

- ① HRC 70 고경도 제품 절삭가능(열처리된 제품 가공가능)
PGM 기준에 의해 만들어진 최고 품질의 콘크리트 드릴 팁 사용
- ② 임팩작업에 적합
- ③ 높은 온도의 구리용접으로 최대 섭씨 1,100℃까지 견딤
- ④ 플렉시블 크롬바나듐 샹크(Chrome Vanadium Shank)
- ⑤ 새로운 콘크리트 드릴 프루트(Flute) 디자인으로 칩배출과 먼지배출에 뛰어나



<B3>

ORDER NO.	MODEL NO.	규격(mm)	PRICE, ₩ Ea.	전장(mm)	포장단위 Ea. / Pk.
0266-754	ACD-3.0	3	1,180	70	
0266-755	ACD-3.5	3.5	1,180	75	
0266-756	ACD-4.0	4	1,180	80	1 / 10
0266-757	ACD-5.0	5	1,480	90	
0266-758	ACD-5.5	5.5	1,880	95	
0266-759	ACD-6.0	6	1,960	100	
0266-760	ACD-6.5	6.5	1,960	105	1 / 10
0276-614	ACD-7.0	7	2,170	110	
0266-761	ACD-8.0	8	2,560	120	1 / 10
0266-762	ACD-9.0	9	3,050	130	1 / 10
0266-763	ACD-10.0	10	3,530	140	
0266-764	ACD-11.0	11	4,520	160	1 / 10
0266-765	ACD-12.0	12	4,620	160	
0266-766	ACD-13.0	13	6,480	200	1 / 10
0266-767	ACD-14.0	14	6,670	200	1 / 10



콘크리트 6각 드릴/비트, Masonry Drill Bit (Hex Shank)

다국적



- PGM 기준에 의해 만들어진 독일 최고 품질의 CERATIZIT 팁사용
- 뛰어난 절삭 능력과 절삭스피드
- 정밀 가공된 콘크리트드릴 팁(TIP) 사용으로 세라믹 타일작업시 성능우수
- 피삭재 콘크리트, 돌, 화강암, 철, 나무, 유리, 세라믹 타일 등에 사용 가능



<B3>

ORDER NO.	MODEL NO.	규격(mm)	PRICE, ₩ Ea.	전장(mm)	포장단위 Ea. / Pk.
0407-191	ACD-3H	3	1,770	70	
0407-192	ACD-3.5H	3.5	1,770	75	1 / 10
0407-197	ACD-4H	4	1,880	80	
0407-198	ACD-5H	5	2,070	90	1 / 10

ORDER NO.	MODEL NO.	규격(mm)	PRICE, ₩ Ea.	전장(mm)	포장단위 Ea. / Pk.
0407-199	ACD-6H	6	2,660	100	1 / 10
0407-201	ACD-6.5H	6.5	2,750	105	1 / 10
0407-203	ACD-8H	8	3,240	120	1 / 10
0407-204	ACD-10H	10	4,420	140	1 / 10



절단석, Cutting Wheel

다국적



- 스테인리스, 스틸 겸용
- 부드러운 연삭성 및 쾌삭
- 튼튼한 내구성
- 깔끔한 절단면과 긴 수명
- 잡음, 진동이 적은 탁월한 작업효과

<B3>

ORDER NO.	MODEL NO.	외경 (mm)	PRICE, ₩ Ea.	두께 (mm)	내경 (mm)	포장단위 Ea. / Pk.
0525-631	ECD-75	75	700	1.2	9.5	1 / 25
0424-710	ECD-105	105	700	1.0	16	1 / 50
0424-711	ECD-125	125	890	1.0	16	1 / 50
0440-058	ECD-180	180	1,380	1.8	22	1 / 30

Articles	Cat. No	Description
----------	---------	-------------



(1)



(2)



(1)



(2)



3M® Cutting Wheels, High Cut Rates & Long Life, Durable, Max. RPM 14,550
Suitable for Cutting Fiberglass · Stainless-steel · Mild steel, 표준형 절단석

■ 우수한 절단력과 유연성(스테인리스 스틸, 마일드 스틸 및 특수 합금 등) 다양한 절단 작업 사용 가능
* Max. RPM 14,550 * 3M PSG (Precision Shaped Grain) Abrasive Particle

<B4>

- 3M.PN1994** (1) Cutting Wheels, od ϕ 105mm \times id ϕ 9.53mm, Thickness 1.3mm
- 3M.PN65147** (2) Cutting Wheels, od ϕ 105mm \times id ϕ 16mm, Thickness 1.0mm
- 3M.PN65148**, od ϕ 105mm \times id ϕ 9.53mm, Thickness 1.3mm
- 3M.PN65139**, od ϕ 125mm \times id ϕ 16mm, Thickness 1.0mm

Ea.	Price, ₩	Cs.	Price, ₩
	3,080	50ea	149,380
	3,360	50ea	162,960
	3,360	50ea	162,960
	4,630	50ea	224,560

3M® 14 & 16 inch Cutting Wheels, Fast Cutting & Long Life, Durable, Max. RPM 3,850
Ideal for Cutting Stainless steel, Ceramic Abrasive Grain Content, 푸른돌 절단석, 14 & 16인치

■ 연삭력, 다양한 스텐 절단 작업에 사용, 견고한 레진 본디드 구조, 내구성 우수
* Max. RPM 3,850 * Good Grinding Force

<B4>

(1) Standard type-Made of Aluminum Oxide

- 3M.08.1051** Cutting Wheels, od ϕ 355mm \times id ϕ 254mm, Thickness 3.0mm
- 3M.08.1052**, od ϕ 405mm \times id ϕ 254mm, Thickness 3.0mm

Ea.	Price, ₩	Cs.	Price, ₩
	3,230	5ea	
	5,650	5ea	

(2) Premium type-Made of Aluminum Zirconia

- 3M.08.1053** Cutting Wheels, od ϕ 355mm \times id ϕ 254mm, Thickness 3.0mm
- 3M.08.1054**, od ϕ 405mm \times id ϕ 254mm, Thickness 3.5mm

Ea.	Price, ₩	Cs.	Price, ₩
	7,000	5ea	
	9,040	5ea	

절단석 (3PCS), Cutting Disc

- 3인치 전용 절단석
- 철재 및 스테인리스 전용 절단석

<B3>



다이아몬드 절단석 (세라믹용) Diamond Cutting Disc

- 3인치 전용 다이아몬드 절단석
- 석재/콘크리트 전용

<B3>

ORDER NO.	MODEL NO.	PRICE, ₩	외경 (")	내경(mm)	전압
0528-389	WA6076.3	4,600	3"(76mm)	9.5	20V

ORDER NO.	MODEL NO.	PRICE, ₩	외경 (")	내경(mm)	전압
0528-390	WA6075	5,600	3"(76mm)	9.5	20V



3M® Ceramic Abrasive Grinding Wheel, Durable, 4 & 7 inch, Grit 24~80, Max. RPM 15,300
Suitable for Variety of Metals, Made of Aluminum Zirconia, 그라인딩 디스크

■ 목적에 따라 방수 선정가능 ■ 다양한 연삭 작업 가능 ■ 우수한 연삭력과 유연성
* Helping to Increase Productivity and Throughput

<B4>

- 3M.08.1055** Grinding Wheel, 4inch, #36, od ϕ 100mm \times id ϕ 16mm, Thickness 2.0mm
- 3M.08.1056**, #60, od ϕ 100mm \times id ϕ 16mm, Thickness 2.0mm
- 3M.08.1057**, #80, od ϕ 100mm \times id ϕ 16mm, Thickness 2.0mm
- 3M.08.1058**, 7inch, #24, od ϕ 180mm \times id ϕ 22mm, Thickness 6.0mm

Ea.	Price, ₩	Cs.	Price, ₩
	2,510	20ea	
	2,510	20ea	
	2,510	20ea	
	6,380	10ea	

KTH

디스크휠페이퍼(연마), Abrasive Flap Disc KOREA



■ 낮장수 : 45장

◀ 정면

ORDER NO.	규격(INCH)	입도(#)	PRICE, ₩ Ea.	포장단위 Ea. / Pk.
0294-865		40	880	
0294-874		50	880	
0294-866	4	60	880	1 / 100
0294-867		80	880	
0294-868		100	880	
0294-869		120	880	
0294-870		150	880	
0294-871	4	180	880	1 / 100
0294-872		220	880	
0294-873		320	880	

Articles

Cat. No

Description



연마석, Grinding-Cup Wheel

KOREA



▲ A석(외경 150)

▲ WA석(외경 180)

▲ GC석(외경 150)

ORDER NO.	규격 (INCH)	PRICE, ₩ Ea.	외경 (#)	입도 (#)	두께 (mm)	내경 (mm)	타입	포장단위 Ea. / Pk.
▶ 0254-320	6	6,900	150	36	25	15.88		1 / 20
0254-321	8	12,380	205	36	25	15.88	A석	1 / 10
0254-322	10	20,950	255	36	25	25.4		1 / 10
0256-798	7	9,050	180	46	19	31.75		1 / 10
▶ 0263-070	7	10,030	180	80	6	31.75	WA석	1 / 20
0266-191	8	15,720	205	80	25	15.88		1 / 10
▶ 0254-324	6	12,320	150	80	25	15.88		1 / 20
0254-325	8	22,190	205	80	25	15.88	GC석	1 / 10
0254-326	10	37,420	255	80	25	25.4		1 / 10

<B3>



- 3인치 전용 옵세트
- 금형류의 세밀한 가공 작업에 최적



옵세트/연마석, Depressed Center Wheel

다국적

ORDER NO.	MODEL NO.	PRICE, ₩	외경 (")	내경(mm)	전압
0528-391	WA6074	2,360	3"(76mm)	9.5	20V

<B3>



연마 디스크샌더페이퍼 (벨크로), ϕ 5inch, Abrasive Paper Disc (Velcro)

KOREA



▲ 앞



▲ 뒤 (벨크로)

ORDER NO.	규격 (외경INCH x 홀수)	입도(#)	PRICE, ₩ Ea.	포장단위 Ea. / Pk.
0305-041		60	31,050	
0305-013		80	31,050	
0305-045	5"×6홀	100	31,050	1 / 100
0305-042		120	31,050	
0305-046		150	27,720	
0305-047		180	27,720	
0305-048	5"×6홀	220	27,720	1 / 100
0305-049		320	27,720	
0305-050		400	27,720	

<B3>



3M® Cubitron™ II "982C" Fibre Disc, for Carbon Steel, 4&7 inch, Grit 36~80, Max. RPM 13,300 High Productivity, Long Lasting, Less Grinding Pressure, 화이버 디스크

- PSG 미네랄의 사용으로 우수한 연삭력으로 작업 효율성이 높음
- 용접, 바벨링, 게이트제거 및 디버링등 다양한 작업에서 광범위하게 사용

* Stiff Fiber Backing and a Strong Resin Bond Provide Durability and Tear-resistance for Heavyweight Applications such as High-pressure Weld Grinding and Beveling

<B4>

3M.08.1061	Fibre Disc, 4inch, #36, od ϕ 100mm × id ϕ 16mm	Pk.	Price, ₩	Cs.	Price, ₩
3M.08.1062	, #60, od ϕ 100mm × id ϕ 16mm	25ea	59,510	4pk	184,690
3M.08.1063	, #80, od ϕ 100mm × id ϕ 16mm	25ea	60,560	4pk	187,950
3M.08.1064	, 7inch, #36, od ϕ 180mm × id ϕ 22mm	25ea	60,560	4pk	187,950
		25ea	105,710	4pk	328,100



3M® Scotch Brite™ Bevel Disc, Durable, Non-woven Fabric, Grit 120~400, Max. RPM 12,000 Ideal for Remove Residue after Welding, Buffing the Surface, 베벨 디스크, 그라인드

- 4인치 전동그라인더에 원터치로 장착가능
- 색상에 따라 거칠기(방수)가 다름
- 3차원 구조로 굴곡진 부위, 코너작업에 용이

* Black : 강판의 흑피, 녹 제거
 Red : 녹, 도막, 중도페인트 제거
 Brown : 용접 후 탄자국 제거
 Green : 버핑 작업, 도장전 마무리 작업

<B4>

3M.08.1071	Bevel Disc, 90mm × 13mm, #120, Black	Pk.	Price, ₩	Cs.	Price, ₩
3M.08.1072	, 90mm × 10mm, #180, Brown	5ea	49,430	12pk	575,260
3M.08.1073	, 90mm × 13mm, #320, Red	5ea	29,270	12pk	340,600
3M.08.1074	, 90mm × 13mm, #400, Green	5ea	29,270	12pk	340,600
		5ea	29,270	12pk	340,600

Articles	Cat. No	Description																
	분말 소화기 Fire Extinguisher, Dry Chemical	KOREA <B3> ■ 뛰어난 소화력으로 범용(ABC)으로 널리 사용 ■ 압력계 부착으로 육안으로 사용가능 여부 판단 ■ 축압된 용기에 약제는 외부 습기에 응고되지 않음																
	<table border="1"> <thead> <tr> <th>Ea.</th> <th>Price, ₩</th> </tr> </thead> <tbody> <tr> <td>0514-170</td> <td>분말소화기, 1.5kg(차량 겸용)</td> <td>22,060</td> </tr> <tr> <td>0514-175</td> <td>, 3.3kg</td> <td>25,480</td> </tr> <tr> <td>0514-173</td> <td>, 4.5kg</td> <td>45,780</td> </tr> </tbody> </table>	Ea.	Price, ₩	0514-170	분말소화기, 1.5kg(차량 겸용)	22,060	0514-175	, 3.3kg	25,480	0514-173	, 4.5kg	45,780	<table border="1"> <thead> <tr> <th>Ea.</th> <th>Price, ₩</th> </tr> </thead> <tbody> <tr> <td>0514-265</td> <td>미니소화기세트, 345ml</td> <td>13,530</td> </tr> </tbody> </table>	Ea.	Price, ₩	0514-265	미니소화기세트, 345ml	13,530
	Ea.	Price, ₩																
	0514-170	분말소화기, 1.5kg(차량 겸용)	22,060															
0514-175	, 3.3kg	25,480																
0514-173	, 4.5kg	45,780																
Ea.	Price, ₩																	
0514-265	미니소화기세트, 345ml	13,530																
▲ 3.3 kg																		
	345ml 미니 Spray 소화기 세트 Aerosol Type Fire Extinguisher	KOREA <B3> ■ 구성품 : 미니소방관+거치대 ■ Spray분사형, 쉬운 사용법 ■ 소형 휴대용 타입																
	<table border="1"> <thead> <tr> <th>Ea.</th> <th>Price, ₩</th> </tr> </thead> <tbody> <tr> <td>0514-265</td> <td>미니소화기세트, 345ml</td> <td>13,530</td> </tr> </tbody> </table>	Ea.	Price, ₩	0514-265	미니소화기세트, 345ml	13,530												
	Ea.	Price, ₩																
	0514-265	미니소화기세트, 345ml	13,530															

	소화기 받침대 Extinguisher Stand	KOREA <B3> ■ 발침대형 (3.3kg 용)								
	<table border="1"> <thead> <tr> <th>Ea.</th> <th>Price, ₩</th> </tr> </thead> <tbody> <tr> <td>0514-873</td> <td>소화기 stand, 1.5kg용</td> <td>2,840</td> </tr> <tr> <td>0514-874</td> <td>, 3.3kg용</td> <td>2,840</td> </tr> </tbody> </table>	Ea.	Price, ₩	0514-873	소화기 stand, 1.5kg용	2,840	0514-874	, 3.3kg용	2,840	
	Ea.	Price, ₩								
	0514-873	소화기 stand, 1.5kg용	2,840							
0514-874	, 3.3kg용	2,840								
▲ 발침대형 (3.3kg 용)										
	소화기 표지판 Extinguisher Guide	KOREA <B3> ■ 축광 아크릴타입								
	<table border="1"> <thead> <tr> <th>Ea.</th> <th>Price, ₩</th> </tr> </thead> <tbody> <tr> <td>0514-882</td> <td>소화기표지판</td> <td>3,860</td> </tr> </tbody> </table>	Ea.	Price, ₩	0514-882	소화기표지판	3,860				
	Ea.	Price, ₩								
	0514-882	소화기표지판	3,860							

, Hammers 망치

	바루망치, Claw Hammer	KOREA <B3>																																
	<table border="1"> <thead> <tr> <th>ORDER NO.</th> <th>규격</th> <th>PRICE, ₩</th> <th colspan="3">mm</th> <th>g</th> <th>포장단위</th> </tr> <tr> <th></th> <th></th> <th>Ea.</th> <th>두경</th> <th>두장</th> <th>전장</th> <th>중량</th> <th>Ea. / Pk.</th> </tr> </thead> <tbody> <tr> <td>0310-173</td> <td>소</td> <td>6,890</td> <td>35</td> <td>103</td> <td>350</td> <td>410</td> <td>1 / 10</td> </tr> <tr> <td>0310-172</td> <td>중</td> <td>7,060</td> <td>27</td> <td>117</td> <td>350</td> <td>610</td> <td>1 / 10</td> </tr> </tbody> </table>	ORDER NO.	규격	PRICE, ₩	mm			g	포장단위			Ea.	두경	두장	전장	중량	Ea. / Pk.	0310-173	소	6,890	35	103	350	410	1 / 10	0310-172	중	7,060	27	117	350	610	1 / 10	
	ORDER NO.	규격	PRICE, ₩	mm			g	포장단위																										
			Ea.	두경	두장	전장	중량	Ea. / Pk.																										
0310-173	소	6,890	35	103	350	410	1 / 10																											
0310-172	중	7,060	27	117	350	610	1 / 10																											
두경																																		

	자석바루망치, Magnetic Claw Hammer	KOREA <B3>																																
	<table border="1"> <thead> <tr> <th>ORDER NO.</th> <th>MODEL NO.</th> <th>PRICE, ₩</th> <th colspan="3">mm</th> <th>g</th> <th>포장단위</th> </tr> <tr> <th></th> <th></th> <th>Ea.</th> <th>두경</th> <th>두장</th> <th>전장</th> <th>중량</th> <th>Ea. / Pk.</th> </tr> </thead> <tbody> <tr> <td>0371-295</td> <td>C330</td> <td>12,160</td> <td>27</td> <td>200</td> <td>330</td> <td>620</td> <td>1 / 8</td> </tr> <tr> <td>▶ 0371-296</td> <td>C400</td> <td>12,850</td> <td>27</td> <td>200</td> <td>390</td> <td>660</td> <td>1 / 8</td> </tr> </tbody> </table>	ORDER NO.	MODEL NO.	PRICE, ₩	mm			g	포장단위			Ea.	두경	두장	전장	중량	Ea. / Pk.	0371-295	C330	12,160	27	200	330	620	1 / 8	▶ 0371-296	C400	12,850	27	200	390	660	1 / 8	
	ORDER NO.	MODEL NO.	PRICE, ₩	mm			g	포장단위																										
			Ea.	두경	두장	전장	중량	Ea. / Pk.																										
0371-295	C330	12,160	27	200	330	620	1 / 8																											
▶ 0371-296	C400	12,850	27	200	390	660	1 / 8																											
▲ C400																																		

	벙가망치, Brick Cut Hammer	KOREA <B3>																								
	<table border="1"> <thead> <tr> <th>ORDER NO.</th> <th>MODEL NO.</th> <th>PRICE, ₩</th> <th colspan="3">mm</th> <th>g</th> <th>포장단위</th> </tr> <tr> <th></th> <th></th> <th>Ea.</th> <th>두경</th> <th>두장</th> <th>전장</th> <th>중량</th> <th>Ea. / Pk.</th> </tr> </thead> <tbody> <tr> <td>0416-485</td> <td>B330</td> <td>12,160</td> <td>25</td> <td>121</td> <td>330</td> <td>660</td> <td>1 / 8</td> </tr> </tbody> </table>	ORDER NO.	MODEL NO.	PRICE, ₩	mm			g	포장단위			Ea.	두경	두장	전장	중량	Ea. / Pk.	0416-485	B330	12,160	25	121	330	660	1 / 8	
	ORDER NO.	MODEL NO.	PRICE, ₩	mm			g	포장단위																		
			Ea.	두경	두장	전장	중량	Ea. / Pk.																		
0416-485	B330	12,160	25	121	330	660	1 / 8																			

	용접망치, Welding Hammer	KOREA <B3>																					
	<table border="1"> <thead> <tr> <th>ORDER NO.</th> <th>PRICE, ₩</th> <th colspan="3">mm</th> <th>g</th> <th>포장단위</th> </tr> <tr> <th></th> <th>Ea.</th> <th>두경</th> <th>두장</th> <th>전장</th> <th>중량</th> <th>Ea. / Pk.</th> </tr> </thead> <tbody> <tr> <td>0310-174</td> <td>6,200</td> <td>28</td> <td>163</td> <td>340</td> <td>310</td> <td>1 / 10</td> </tr> </tbody> </table>	ORDER NO.	PRICE, ₩	mm			g	포장단위		Ea.	두경	두장	전장	중량	Ea. / Pk.	0310-174	6,200	28	163	340	310	1 / 10	
	ORDER NO.	PRICE, ₩	mm			g	포장단위																
		Ea.	두경	두장	전장	중량	Ea. / Pk.																
0310-174	6,200	28	163	340	310	1 / 10																	
■ 용접 후 발생하는 용접의 잔해 제거에 용이 함																							

	경량판금망치, Metal Hammer	KOREA <B3>																								
	<table border="1"> <thead> <tr> <th>ORDER NO.</th> <th>MODEL NO.</th> <th>PRICE, ₩</th> <th colspan="3">mm</th> <th>g</th> <th>포장단위</th> </tr> <tr> <th></th> <th></th> <th>Ea.</th> <th>두경</th> <th>두장</th> <th>전장</th> <th>중량</th> <th>Ea. / Pk.</th> </tr> </thead> <tbody> <tr> <td>0502-730</td> <td>PT300</td> <td>11,470</td> <td>32</td> <td>155</td> <td>300</td> <td>520</td> <td>1 / 20</td> </tr> </tbody> </table>	ORDER NO.	MODEL NO.	PRICE, ₩	mm			g	포장단위			Ea.	두경	두장	전장	중량	Ea. / Pk.	0502-730	PT300	11,470	32	155	300	520	1 / 20	
	ORDER NO.	MODEL NO.	PRICE, ₩	mm			g	포장단위																		
			Ea.	두경	두장	전장	중량	Ea. / Pk.																		
0502-730	PT300	11,470	32	155	300	520	1 / 20																			

BHS 돌망치, Stone Hammer

KOREA



▲ SM230

ORDER NO.	MODEL NO.	규격	PRICE, ₩ Ea.	mm			g 중량	포장단위 Ea. / Pk.
				두경	두장	전장		
▶ 0444-783	SM230	미니	12,160	38	105	230	924	1 / 6
0371-299	SM330	중	12,160	40	108	330	1,400	1 / 6
0371-297	SL340	대	12,850	44	113	340	1,700	1 / 6

<B3>

KDY 고무망치, Rubber Hammer

다국적



- 내구성 우수한 나무 그립
- 고탄력의 고무재질

<B3>

ORDER NO.	MODEL NO.	PRICE, ₩ Ea.	두경 (mm)	두장 (mm)	전장 (mm)	중량 (g)	포장단위 Ea. / Pk.
0437-525	KHM-08	1,890	45	80	270	270	1 / 12
0437-527	KHM-12	2,270	53	90	280	280	1 / 12
0437-528	KHM-24	3,790	64	110	330	330	1 / 8

SUNKEY 납볼 망치, Dead Blow Hammer

TAIWAN

- 납볼이 들어있어 충격흡수 탁월!



- 열가소성 고무재질로 내구성 우수
- 강한 충격에 뛰어난 흡수성

<B3>

ORDER NO.	MODEL NO.	PRICE, ₩ Ea.	두경 (mm)	두장 (mm)	전장 (mm)	중량 (g)	포장단위 Ea. / Pk.
0442-194	SBR-35	12,200	35	90	280	400	1 / 16
0442-202	SBR-45	15,660	45	90	300	580	1 / 10
0465-896	SBR-50	18,120	50	100	320	795	1 / 8
0442-203	SBR-55	20,030	55	110	355	1,050	1 / 8
0465-897	SBR-60	23,120	60	120	360	1,280	1 / 6

우레탄 망치, Urethane Hammer

KOREA

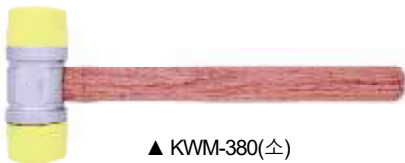

▲ KWM-380(소)

- 특수 우레탄으로 탄성과 수명이 김
- 철재 및 조립공정에 사용
- 공작물 타격 시 손상이 없음

<B3>

ORDER NO.	MODEL NO.	PRICE, ₩ Ea.	mm			g 중량	포장단위 Ea. / Pk.
			두경	두장	전장		
▶ 0296-474	KWM-380(소)	9,000	38	125	305	380	
0296-476	KWM-500(중)	9,800	47	125	340	500	1 / 6
0296-477	KWM-750(대)	11,760	55	145	360	750	

우레탄 망치용 팁 스페어, Urethane Hammer Spare

KOREA



◀ KW-380

- 마모 시 교체하여 사용할 수 있음

<B3>

ORDER NO.	MODEL NO.	PRICE, ₩	규격
▶ 0353-129	KW-380	1,810	小
0353-128	KW-500	2,130	中
0353-127	KW-750	2,460	大



BHS 손도끼, Chis Axe with Tubular Handle EL Hammer

KOREA

<B3>

ORDER NO.	MODEL NO.	PRICE, ₩ Ea.	mm			g 중량	포장단위 Ea. / Pk.
			두경	두장	전장		
0397-129	A300	12,160	22	112	300	750	1 / 6

Articles	Cat. No	Description
		11-parts Stainless-steel Multi-Knife & Tool, with Hanging Loop, L87mm, 100g 11 Tools in 1, Easy to Carry, All-purpose Tool, 다용도 나이프 공구
		* Clear Plastic BLISTER Packing with Description Card * Consist of : Screwdriver, Leather Punch, Metal Saw, Sewing Eye, Corkscrew, Multi-purpose Hook, Flathead, Cap Lifter, Large Blade, Wood Saw, Fish Scalper, Hook Disgorger, Scissors, Can Opener
11skill Multi-Knife & Tool	D16.99583	Multi-Knife & Tool, 11-parts, L87mm, 100g
		Ea. Price, ₩ 10,950

멀티툴, 소형 다용도, Compact Multifunction Tools

다국적



(1) Knife with 3-Skill

- 재질 : 스테인리스강
- 전장 : 90mm×33mm
- 안전고리, 오프너, 스페너



<B3>

ORDER NO.	MODEL NO.	PRICE, ₩ Ea.	포장단위 Ea. / Pk.
0432-665	TU573	16,640	1 / 6

(3) 8-Skill with Knife

- 규격 : 78mm×32mm×16mm
- 플라이어, 와이어커터, 십자 드라이버, 일자 드라이버, 고강도 스테인리스강 나이프, 톱, 카라비너 등



ORDER NO.	MODEL NO.	PRICE, ₩ Ea.	포장단위 Ea. / Pk.
0494-806	TU197	22,550	1 / 6



(5) 13-Skill with Bits

- 규격 : 113mm×42mm×28mm
- 플라이어, 와이어커터, 십자 드라이버, 톱, 톱니날, 칼, 썸스터드, 오프너, 파일, 십자비트, 일자형비트, 육각비트, 자석비트홀더 등



ORDER NO.	MODEL NO.	PRICE, ₩ Ea.	포장단위 Ea. / Pk.
0525-227	TU181	33,190	1 / 6

(2) 8-Skill with Saw

- 플라이어, 와이어커터, 오프너, 스크류드라이버, 다용도칼, 파일, 톱, 가위



ORDER NO.	MODEL NO.	PRICE, ₩ Ea.	포장단위 Ea. / Pk.
0432-664	TU195	15,960	1 / 6

(4) 9-Skill with Pliers

- 규격 : 103mm×47mm×12mm
- 플라이어, 와이어커터, 십자 드라이버, 일자 드라이버, 톱, 나이프, 송곳, 오프너, 야스리 등



ORDER NO.	MODEL NO.	PRICE, ₩ Ea.	포장단위 Ea. / Pk.
0494-807	TU194	22,550	1 / 6



(6) 30-Skill with Ruler

- 규격 : 127mm×38mm×12mm
- 가죽파우치 포함, 자전거용으로 최적합
- 십자 드라이버, 일자 드라이버, 스포크렌치, 야스리, 오프너, 자, 커터/스트리퍼 등 약 30여가지 기능



▶ 포장이미지

ORDER NO.	MODEL NO.	PRICE, ₩ Ea.	포장단위 Ea. / Pk.
0494-802	TU210	31,920	1 / 8

, Pliers 니퍼/뺨치/플라이어

KDY 니퍼, Diagonal Cutting Pliers

다국적

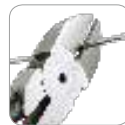

- 피복, 동선 절단이 편리하여 전기작업에 최적
- 전선 피복 제거 용이

<B3>

ORDER NO.	MODEL NO.	PRICE, ₩ Ea.	규격	절단능력 (mm)	포장단위 Ea. / Pk.
▶ 0360-164	KNP-125	3,530	125(5")	연선 2.0	
0433-142	KNP-150	3,340	150(6")	연선 2.3/강선 1.6	1 / 6
0387-450	KNP-175	4,230	175(7")	연선 3.0/강선 1.8	

KDY 뺨치, Side Cutting Pliers

다국적



- 철사 등의 강선을 절단하는데 사용
- 강화 고무그립 손잡이

<B3>

ORDER NO.	MODEL NO.	PRICE, ₩ Ea.	규격	절단능력 (mm)	포장단위 Ea. / Pk.
0364-307	KSP-150	4,530	150(6")	연선 2.3/강선 1.6	1 / 6
▶ 0364-308	KSP-175	4,940	175(7")	연선 2.6/강선 1.8	1 / 6
0433-143	KSP-200	4,520	200(8")	연선 3.0/강선 2.0	1 / 6

KDY 압착뺨치, High Leverage Side Cutting Pliers 다국적



■ 동선 및 부드러운 와이어 커팅 사용 ■ 우수한 내구성. 편안한 그림감

<B3>

ORDER NO.	MODEL NO.	PRICE, ₩ Ea.	규격	절단능력 (mm)	포장단위 Ea. / Pk.
0244-233	KCP-225	13,720	225(9")	연선 3.0/강선 2.0	1 / 6

KDY 롱노즈플라이어, Long Nose Pliers 다국적



■ 철사나 전선을 휘거나 절단 ■ 조립, 분해, 수리에 최적

<B3>

ORDER NO.	MODEL NO.	PRICE, ₩ Ea.	규격	절단능력 (mm)	포장단위 Ea. / Pk.
▶ 0360-166	KLP-125	3,530	125(5")	연선 1.5/강선 1.2	1 / 6
0433-141	KLP-150	3,340	150(6")	연선 2.0/강선 1.6	1 / 6
0360-167	KLP-200	4,520	200(8")	연선 2.5/ 1.8	1 / 6

KDY 다목적 롱노즈플라이어, Multiple Type Long Nose Pliers 다국적

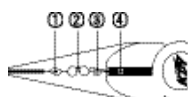

- ① 작은나사, 너트 등(다이아 형) 사용가능
- ② 코드의 절단 분리
- ③ 전선의 접속 혹은 압착단자용 압착기능 추가
- ④ 선재의 피복용

<B3>

ORDER NO.	MODEL NO.	PRICE, ₩ Ea.	규격	절단능력 (mm)	포장단위 Ea. / Pk.
0244-547	KMP-150	4,810	150(6")	연선 3.0/강선 2.0	1 / 6

KDY 워터펌프 플라이어, Water Pump Pliers 다국적



■ 크롬도금 표면처리 ■ 수도관, 가스관등의 배관공사에 사용

<B3>

ORDER NO.	MODEL NO.	PRICE, ₩ Ea.	규격	최대능력 (mm)	포장단위 Ea. / Pk.
▶ 0364-309	KCL-250	6,480	250(10")	7~55	1 / 6
0364-310	KCL-300	8,150	300(12")	10~65	1 / 6

KDY 플라이어, Slip Joint Pliers 다국적



■ 철사나 전선을 휘거나 절단을 하는 데 사용함

<B3>

ORDER NO.	MODEL NO.	PRICE, ₩ Ea.	규격	포장단위 Ea. / Pk.
▶ 0364-311	KJP-200	4,620	200(8")	1 / 6
0364-312	KJP-250	5,400	250(10")	1 / 6

FUJIYA 전공 니퍼, Electronic Cutting Pliers JAPAN



절단능력(φ)

FRP	철선	동선	VA-WF선	피아노선
∞	1.0	1.8	2.0	-
∞	1.0	1.8	2.0	-

- 초강력날
- 스프링내장

<B3>

ORDER NO.	MODEL NO.	PRICE, ₩ Ea.	규격	포장단위 Ea. / Pk.
0466-063	60S-125	13,240	125(5")	1 / 6
0357-794	60S-150	13,240	150(6")	1 / 6

KDY 스냅링 플라이어, Snap Ring Pliers, 기계나 부품에 있는 스냅링을 간단히 장치하고 탈착 시킴. 다국적

(1) 직벌림 / Snap Ring Plier-outer



(2) 오므림 / Snap Ring Plier-Inner



<B3>

ORDER NO.	MODEL NO.	PRICE, ₩ Ea.	규격	사용범위(mm)	포장단위 Ea. / Pk.
0360-168	KRP-5AS	2,950	125(5")	10~25	1 / 6
0360-171	KRP-7AS	3,820	175(7")	12~65	1 / 6

ORDER NO.	MODEL NO.	PRICE, ₩ Ea.	규격	사용범위(mm)	포장단위 Ea. / Pk.
0360-169	KRP-5BS	2,950	125(5")	10~25	1 / 6
0360-172	KRP-7BS	3,820	175(7")	12~65	1 / 6

Articles	Cat. No	Description
----------	---------	-------------

KDY 산업용 스텐 헤라, Putty Knife, Stainless-steel, for Industry 다국적

경화형 (1) Stability-type, 견고형



- 견고한 PVC 손잡이, Stainless-steel Blade
- 다가네 타입으로 스크래퍼 성능 강화
- 페인트, 장판, 바닥, 벽지, 광고 전단지 이물질 제거 작업등
- 스테인리스 규격 ; Blade Width(Inch)

<B3>

ORDER NO.	MODEL NO.	PRICE, ₩ Ea.	규격	포장단위 Ea. / Pk.
① 0444-100	KHR-114	1,380	1-1/4"	1 / 12
② 0444-101	KHR-02	1,670	2"	1 / 12
③ 0444-102	KHR-03	1,960	3"	1 / 12
④ 0444-103	KHR-04	2,270	4"	1 / 12
⑤ 0444-104	KHR-05	2,750	5"	1 / 6
⑥ 0444-105	KHR-06	3,140	6"	1 / 6

유연형 (2) Flexibility-type, 유연형



- 견고한 PVC 손잡이, Stainless-steel Blade
- 유연형으로 이물질 제거작업에 용이
- 페인트, 장판, 바닥 등에 사용
- 스테인리스 규격 ; Blade Width(Inch)

ORDER NO.	MODEL NO.	PRICE, ₩ Ea.	규격	포장단위 Ea. / Pk.
① 0469-280	KHR-02F	1,150	2"	1 / 12
② 0469-281	KHR-03F	1,480	3"	1 / 12
③ 0469-282	KHR-04F	1,830	4"	1 / 12
④ 0469-283	KHR-05F	2,120	5"	1 / 6
⑤ 0469-284	KHR-06F	2,170	6"	1 / 6

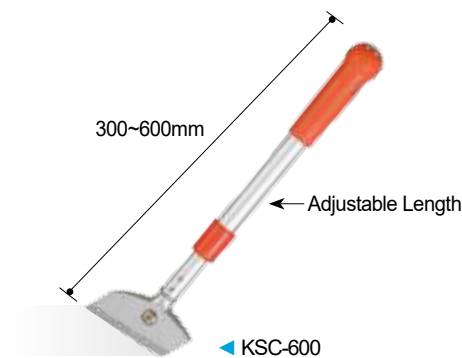

KDY 스크래퍼, 길이조절식, Folding Scraper, for Industry 다국적

- Aluminum Base, TPR Grip.
- ▶ 교체칼날 ; "화신커터" 날 18×100mm
- ▶ 우수한 견고성
- 튼튼한 내구성
- 편리한 칼날교체 ; "화신"



<B3>

ORDER NO.	MODEL NO.	PRICE, ₩ Ea.	규격(mm)	포장단위 Ea. / Pk.
▶ 0500-860	KSC-600	8,830	300~600(2단)	1 / 4

PICUS 실리콘헤라/스패츨러, 다용도, Putty Knife, Good for Foodstuff CHINA



- Silicone Blade
- Bamboo Handle

<B3>

ORDER NO.	규격	PRICE, ₩ Ea.	규격(mm)		포장단위 Ea. / Pk.
			가로	세로	
0462-931	소		30		1 / 10
0468-731	중	1,520	40	280	1 / 10
0468-732	대		45		1 / 10

, Riveters 리베터

PICUS 핸드 리베터, Hand Riveter JAPAN

- 한손사용 ■ 뛰어난 내구성과 사용 편의성



- 재질 : 스틸 <B3>

- 재질 : 알루미늄

ORDER NO.	MODEL NO.	PRICE, ₩ Ea.	사용범위(mm)	포장단위 Ea. / Pk.
▶ 0451-051	HR-003	13,530	2.4~4.8	1 / 6

ORDER NO.	MODEL NO.	PRICE, ₩ Ea.	사용범위(mm)	포장단위 Ea. / Pk.
▶ 0487-719	HR-005N	19,120	2.4~4.8	1 / 6

Articles

Cat. No

Description



에어리베터, Air Riveter

JAPAN

<B3>

NNW-300	리베트 치수(mm)			
	2.4	3.2	4	4.8
○	○	○	○	○

ORDER NO.	MODEL NO.	PRICE, ₩ Ea.	사용범위(mm)	포장단위 Ea. / Pk.
0220-650	NNW-300	116,530	2.4~4.8	1 / 8

, Saws 톱



톱대, 톱날 각도 조절식, Hack Saw Frame, All in Aluminum

다국적

울트라 타입



Ultra-Type

- All in Aluminum
- TRR소재 사용으로 그립감이 우수
- 톱날의 각도를 조절하여 사용 가능



<B3>

ORDER NO.	MODEL NO.	PRICE, ₩ Ea.	날장 mm	전장 mm	포장단위 Ea. / Pk.
0403-615	KHF-823	13,720	300	440×140	1 / 6



접톱, Folding Saw

KOREA

<B3>



(1) DG-1007

(2) DG-103

ORDER NO.	MODEL NO.	PRICE, ₩ Ea.	규격(mm)		포장단위 Ea. / Pk.
			날장	전장	
(1) 0452-017	DG-1007	9,590	130	290	1 / 10
(2) 0452-006	DG-103	6,300	210	440	
0452-007	DG-104	6,750	250	500	



전정톱, Pruning Saw

KOREA

<B3>



▲ DE-607

ORDER NO.	MODEL NO.	PRICE, ₩ Ea.	규격(mm)		포장단위 Ea. / Pk.
			날장	전장	
0452-046	DE-605	9,140	240	400	1 / 10
▶ 0452-048	DE-607	11,470	300	460	
0452-024	DE-701	10,400	335	515	



외날톱, Single Edged Saw

KOREA

<B3>



ORDER NO.	MODEL NO.	PRICE, ₩ Ea.	규격(mm)		포장단위 Ea. / Pk.
			날장	전장	
▶ 0452-032	DE-711	8,250	265	600	1 / 12
0452-033	DE-712		300	630	
0452-034	DE-713		330	660	



외날톱날, Single Edged Saw Blade

KOREA

<B3>



ORDER NO.	MODEL NO.	PRICE, ₩ Ea.	날장(mm)	포장단위 Ea. / Pk.
0452-036	DE-712SB	300		
0452-039	DE-713SB	330		



파이프톱, Pipe Saw

KOREA

<B3>



<B3>

ORDER NO.	MODEL NO.	PRICE, ₩ Ea.	규격(mm)		포장단위 Ea. / Pk.
			날장	전장	
0452-050	DG-643	8,250	240	400	1 / 10



과수전용톱, Fruit Tree Saw

KOREA

<B3>



ORDER NO.	MODEL NO.	PRICE, ₩ Ea.	규격(mm)		포장단위 Ea. / Pk.
			날장	전장	
0452-051	DG-623	12,160	270	450	1 / 10

Articles Cat. No Description

BAHCO 하이스 톱날, HSS Bi-metal Hack Saw Blades 다국적



단위 : mm <B3>

ORDER NO.	규격	PRICE, ₩ Ea.	포장단위 Ea. / Pk.
0210-320	M 300 (12")×18T	1,270	1 / 100
0129-205	M 300 (12")×24T	1,120	1 / 100



※Notice!
Scissors 가위 ⇒ See the "Scissors-section"!

, Screw Extractors 반대탭/히다리탭

KDY 반대탭 세트 (히다리탭) TAIWAN 다국적

Screw Extractor Set



- 11205SQ 구성**
- 2127-06M (1/8"-1/4")
 - 2127-08M (1/4"-5/16")
 - 2127-11M (5/16"-7/16")
 - 2127-14M (7/16"-9/16")
 - 2127-18M (9/16"-3/4")
- 11208SQ 구성**
- 2127-06M (1/8"-1/4")
 - 2127-08M (1/4"-5/16")
 - 2127-11M (5/16"-7/16")
 - 2127-14M (7/16"-9/16")
 - 2127-18M (9/16"-3/4")
 - 2127-24M (3/4"~1")
 - 2127-33M (1"~1-3/8")
 - 2127-50M (1-3/8"~2")

<B3>

ORDER NO.	MODEL NO.	PRICE, ₩ Ea.	세트 수량	포장단위 Ea. / Pk.
0360-105	11205SQ	8,930	5 PCS	1 / 25
0486-821	11208SQ	54,600	8 PCS	1 / 6

KDY T형 탭 핸들 (자동) 다국적

Tap Holder with T-Handle Auto



■ 라쳇 타입으로 한손으로 손쉽게 작업 가능 <B3>

ORDER NO.	MODEL NO.	PRICE, ₩ Ea.	사용범위	포장단위 Ea. / Pk.
0141-940	KHW-38A	8,180	M3~M8	1 / 10
0142-122	KHW-512A	9,730	M5~M12	1 / 10

, Screws/Nails 못

KDY 각종못/나사못 세트, Nail/Screws Assortment 다국적

KZY-01

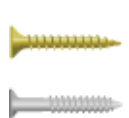

- 구성
- 목공용 피스 : 3.5×25 / 18pcs
 - 일반 피스 : 3.5×25 / 18pcs
- <B3>

ORDER NO.	MODEL NO.	PRICE, ₩ Ea.	포장단위 Ea. / Pk.
0426-470	KZY-01	790	1 / 12

KZY-02



- 구성
- 벽걸이 못(大) : 18pcs
 - 벽걸이 못(小) : 18pcs

ORDER NO.	MODEL NO.	PRICE, ₩ Ea.	포장단위 Ea. / Pk.
0426-471	KZY-02	3,240	1 / 12

<Continued On Next Page>

Articles

Cat. No

Description

<Continued From... 각종못/나사못 세트, Nail/Screws Assortment>

KZY-04



- 구성
- 일반 못 : 1-1/2" / 6pcs
 - 콘크리트 못 : 1-1/2" / 6pcs
 - 목공용 피스 : 4×30 / 6pcs
 - 태핑 나사 : 5×30 / 6pcs
 - 일반 피스 : 3.5×25 / 6pcs
 - 일반 피스 : 6×50 / 6pcs

<B3>

ORDER NO.	MODEL NO.	PRICE, ₩ Ea.	포장단위 Ea. / Pk.
0426-473	KZY-04	1,480	1 / 12

KZY-05



- 구성
- 콘크리트 못 : 1-1/2" / 6pcs
 - 칼블럭 (노랑) : 6pcs
 - 칼블럭 (빨강) : 6pcs
 - 태핑 나사 : 4×20 / 6pcs
 - 목공용 피스 : 5×30 / 6pcs
 - 일반 피스 : 2-1/2" / 6pcs

ORDER NO.	MODEL NO.	PRICE, ₩ Ea.	포장단위 Ea. / Pk.
0426-474	KZY-05	1,480	1 / 12

KZY-06



- 구성
- 일반 피스 : 3.5×25 / 6pcs
 - 일반 못 : 2×40 / 20pcs
 - 일반 피스 : 4×16 / 6pcs
 - 콘크리트 못 : 3×40 / 15pcs
 - 칼블럭 : 6pcs
 - U자형 피스 : 2.5×25 / 4pcs

ORDER NO.	MODEL NO.	PRICE, ₩ Ea.	포장단위 Ea. / Pk.
0426-475	KZY-06	1,670	1 / 12

, Suction Lifters 흡착기(리프터)

SUNKEY 흡착기, Suction Lifter

TAIWAN



(1) SC-40



(2) SC-80



(3) SC-120

- 냉장고, 가구, 유리판 등의 손잡이가 없고 들기 힘든 물건에 흡착시켜 운반을 용이하게 함
- 레버 조작으로 원반하부의 공기를 빨아들여 강하게 흡착

사용방법

- 스틸, 유리, 대리석 등 표면이 평평하고, 단단한 물건에 완전하게 흡착시켜 사용
- 흡판을 고정하려고 하는 부분에 오염물 또는 기름이 묻어 있다면 깨끗이 제거 후 사용
- 흡판을 흡착했으면, 이동하기 전에 완전히 흡착되어 있는지 확인 후 사용
- 흡판을 해제할 때는, 안전한 장소에서 확인 후 흡착을 해제

<B3>

ORDER NO.	MODEL NO.	PRICE, ₩ Ea.	규격	지름(mm)	흡착력(kg)	포장단위 Ea. / Cs.
(1) 0444-187	SC-40	12,750	1구	123	40	1 / 20
(2) 0444-188	SC-80	24,580	2구	117	80	1 / 20
(3) 0444-189	SC-120	36,400	3구	117	120	1 / 10

Articles	Cat. No	Description
----------	---------	-------------

EXSO 터보 납땜 세라믹 인두기, Ceramic Soldering Iron (1), (2) KOREA



- 세라믹 히터 채용에 의한 높은 저항온도 계수로 상승온도 속도가 월등하며 버튼식 출력 전환기능의 첨단 제품
- 터보기능으로 사용이 가능한 고성능의 즉열식 납땜인두

ORDER NO.	MODEL NO.	PRICE, ₩ Ea.	사양	포장단위 Ea. / Pk.
(1) 0471-665	GH-60BN	34,990	220V, 20/120W	1 / 5
(2) 0479-944	EX-90BN	34,990	220V, 20/120W	1 / 5

EXSO 세라믹 인두팁, Ceramic Soldering Tip KOREA



ORDER NO.	적용모델	PRICE, ₩ Ea.	포장단위 Ea. / Pk.
0297-983	980-TB(GH,EX 전규격)	6,550	1 / 10

EXSO 교육용 납땜 인두기, Educational Soldering Iron KOREA

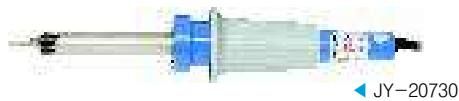

- 인두 가열부의 손상방지 스테인리스 및 캡 볼트 타입 팁 사용
- 우수한 열전도성과 고 절연성으로 경제적인 제품
- 학생 및 전기 전자 관련 실습용으로 적합

ORDER NO.	MODEL NO.	PRICE, ₩ Ea.	사양	포장단위 Ea.
▶ 0297-868	JY-20730	11,680	220V, 30W	1
0283-418	JY-20740	12,260	220V, 40W	1

HAJKO 납땜 인두세트, 온도조절 Soldering Station, Temp. Controlled JAPAN



EXSO 정전기 방지기 (손목밴드) Antistatic Wrist Band KOREA



ORDER NO.	MODEL NO.	PRICE, ₩ Ea.	전원	소비전력(W)	중량(kg)
0515-969	FX-888D	216,590	AC220V 50/60Hz	70	1.2

ORDER NO.	MODEL NO.	PRICE, ₩ Ea.	포장단위 Ea. / Pk.
0481-513	EX-611B	3,770	1 / 15

KOVEA 파워가스 납땜인두, Power Gas Soldering Iron KOREA

- 압전 자동점화
- 사용연료 : 라이터가스
- 토치 최대 화력 1,300℃, 인두촉 최대 화력 400℃, 열풍팁 최대 화력 500℃
- 전기가 필요 없어 장소 제한 없이 사용 가능
- 열풍 팁이 있어 간단한 수축 튜브 작업 가능
- 예열시간이 짧아 점화 후 20초 후 납땜 가능
- 금속공예, 치과 기공 등에 적합



KOVEA 자동가스 납땜인두 II, Auto Gas Soldering Iron II KOREA

- 압전 자동점화
- 사용연료 : 라이터가스
- 토치 최대 화력 1,300℃, 인두촉 최대 화력 400℃, 열풍팁 최대 화력 500℃
- 전기가 필요 없어 장소 제한 없이 사용 가능
- 열풍 팁이 있어 간단한 수축 튜브 작업 가능
- 예열시간이 짧아 점화 후 20초 후 납땜 가능
- 금속공예, 치과 기공 등에 적합



ORDER NO.	MODEL NO.	PRICE, ₩ Ea.	규격(mm)	중량(g)	포장단위 Ea. / Pk.
0481-165	KTS-2712	36,560	350×100×50	120	1 / 20

ORDER NO.	MODEL NO.	PRICE, ₩ Ea.	규격(mm)	중량(g)	포장단위 Ea. / Pk.
0481-164	KTS-2710	27,440	272×100×45	79	1 / 20

EXSO 납흡입기, Desoldering Pump KOREA

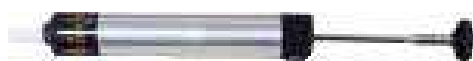

- 강력한 흡입력의 초경량, 컴팩트형으로 교환용 납 흡입기
- 간단한 노즐 교환으로 작업능률 향상

ORDER NO.	MODEL NO.	PRICE, ₩ Ea.	포장단위 Ea. / Pk.
0292-498	DS-1010	6,550	1 / 20

KDY 14pcs 보급형 공구세트, General Purpose Tool Set/14pcs

다국적



14 PCS

<B3>

제품 구성			
롱노우즈 플라이어	6"	위터펌프 플라이어	10"
니퍼	6"	몽키스패너	8"
뺨치	7"	빠루망치	12oz
플라이어	8"	드라이버 세트	6pcs
		접톱	180mm

ORDER NO.	MODEL NO.	PRICE, ₩ Ea.	세트 수량	포장단위 Ea. / Pk.
0461-561	KTS-14	46,070	14 PCS	1 / 10

KDY 18pcs 대중인기형 공구세트, Popular Tool Set/18pcs

다국적



18 PCS

<B3>

제품 구성			
롱노우즈 플라이어	6"	빠루망치	12oz
니퍼	6"	드라이버 세트	6pcs
뺨치	7"	접톱	180mm
플라이어	8"	나사못세트	6종
위터펌프 플라이어	10"	다목적 칼	18mm
몽키스패너	8"	줄자	3M
		절연테이프	-

ORDER NO.	MODEL NO.	PRICE, ₩ Ea.	세트 수량	포장단위 Ea. / Pk.
0461-562	KTS-18	57,830	18 PCS	1 / 10

CSL KOREA 25pcs 전문가용 공구 세트, Professional Tool Set/25pcs

KOREA



25PCS(전문가용)

<B3>

제품 구성			
몽키스패너	250(10")	멈춤형 줄자	2M
원예용전정가위	175(7")	절연테이프	전기용
콤비네이션플라이어	150(6")	드라이버	⊕ φ6×100
뺨치	150(6")		⊖ φ6×100
강력니퍼	160(6")		⊕ φ4×75
익스텐션바	1/2"Dr-5"	⊖ φ4×75	검전드라이버
방청유	WD-40	⊖ φ5×60	
라쳇핸들	1/2"Dr	송곳	⊙φ3×60
망치	12 Oz	소켓	1/2"Dr 17,19,12
접톱	180	파이프렌치	250(10")
못통	7 PCS	라디오뺨치	160(6")
		가방	-

ORDER NO.	MODEL NO.	PRICE, ₩	세트 수량
0108-654	T6KL001	110,940	25 PCS

Articles	Cat. No	Description
----------	---------	-------------



다용도 공구집 (6구)

Project Pouch

- 못, 망치, 드라이버 등 보관용이
- 6개 포켓 및 홀더로 구성
- 인체공학적 디자인
- 줄자 및 망치 보관 용이

<B3>

ORDER NO.	0441-974
MODEL NO.	TB-CT-24
Ea. PRICE, ₩	21,640
규격(mm)	200×240
포장단위 Ea. / Pk.	1 / 4



다용도 공구집 (9구)

Warehouse Pouch

- 휴대폰 및 미니 노트 등 보관 용이
- 여러개의 테이프를 보관가능
- 9개 포켓 및 홀더로 구성
- 강화 리벳으로 내구성 우수

<B3>

ORDER NO.	0441-980
MODEL NO.	TB-CT-32-A
Ea. PRICE, ₩	26,470
규격(mm)	200×230
포장단위 Ea. / Pk.	1 / 4



다용도 공구집 (13구)

Small Electrician Pouch

- 내용물 쏟아짐 현상 방지
- 13개 포켓 및 홀더로 구성
- 콤팩트한 파우치 디자인
- 전기 작업공구 보관에 최적합

<B3>

ORDER NO.	0441-965
MODEL NO.	TB-CT-34
Ea. PRICE, ₩	37,290
규격(mm)	200×250
포장단위 Ea. / Pk.	1 / 3



다용도 공구집 (5구)

Tape Measure Pouch

- 5개 포켓 및 홀더로 구성
- 줄자 전용 보관 포켓
- 드라이버 보관 포켓
- 내구성 우수한 6중 보강 구조

<B3>

ORDER NO.	0441-976
MODEL NO.	TB-CT-25
Ea. PRICE, ₩	15,650
규격(mm)	170×200
포장단위 Ea. / Pk.	1 / 6



다용도 공구집 (7구)

Tape Measure

- 7개 포켓 및 홀더로 구성
- 미니 노트 및 연필 포켓
- 줄자 전용 포켓
- 커터칼 전용 포켓

<B3>

ORDER NO.	0441-975
MODEL NO.	TB-CT-25X
Ea. PRICE, ₩	21,640
규격(mm)	150×230
포장단위 Ea. / Pk.	1 / 3



다용도 공구집 (8구)

Universal Pouch

- 커터칼 전용 포켓
- 줄자 전용 클립
- 8개 포켓 및 홀더로 구성
- 휴대폰 보관 용이

<B3>

ORDER NO.	0441-971
MODEL NO.	TB-CT-26
Ea. PRICE, ₩	18,700
규격(mm)	160×220
포장단위 Ea. / Pk.	1 / 4



다용도 공구집 (8구)

Technician Pouch

- 8개 포켓 및 홀더로 구성
- 4개 드라이버 전용 포켓
- 전공드라이버 보관 최적합
- 줄자 보관 포켓

<B3>

ORDER NO.	0441-983
MODEL NO.	TB-CT-36-L6
Ea. PRICE, ₩	24,580
규격(mm)	120×250
포장단위 Ea. / Pk.	1 / 4



Articles

Cat. No

Description

다용도 공구집 (11구/12구)

Technician Pouch

- 플라이어, 전공드라이버, 줄자 보관용이
- 길이조절 기능의 스트랩 장착
- 내구성 우수한 6중 보강 구조
- 메모 보관 포켓



<B3>

ORDER NO.	0441-984	0441-982
MODEL NO.	TB-CT-36-M7	TB-CT-36-L7
Ea. PRICE, ₩	28,460	30,460
규격(mm)	120×220	130×270
포장단위 Ea. / Pk.	1 / 4	1 / 3

다용도 공구집 (14구/15구)

Technician Pouch

- 14개 포켓 및 홀더로 구성
- 줄자 전용 보관 클립
- 길이 조절 기능의 스트랩
- 효율적인 수납공간의 디자인



<B3>

ORDER NO.	0444-352	0452-789
MODEL NO.	TB-CT-36-M10	TB-CT-36-L10
Ea. PRICE, ₩	32,350	34,340
규격(mm)	100×230	120×270
포장단위 Ea. / Pk.	1 / 3	1 / 2

다용도 공구집 (3구/3구/4구)

Pliers Pouch

- 4개 포켓 및 홀더로 구성
- 줄자 전용 보관 클립
- 길이조절 가능한 스트랩
- 전공드라이버 전용 포켓



<B3>

ORDER NO.	0446-470	0446-471	0441-985
MODEL NO.	TB-CT-35-S	TB-CT-35-M	TB-CT-35-L
Ea. PRICE, ₩	19,220	21,330	21,640
규격(mm)	90×200	100×230	120×270
Ea. / Pk.	1 / 5	1 / 5	1 / 5

다용도 공구집 (7구)

Driver Pouch

- 7개 포켓 및 홀더로 구성
- 3개 드라이버 전용 포켓
- 전기 작업공구 보관용이
- 내구성 우수



<B3>

ORDER NO.	0441-989
MODEL NO.	TB-CT-36-4
Ea. PRICE, ₩	19,650
규격(mm)	140×230
포장단위 Ea. / Pk.	1 / 5

다용도 공구집 (11구)

Technician Pouch

- 11개 포켓 및 홀더로 구성
- 커터칼 전용 포켓
- 줄자 전용 클립
- 내구성 우수한 6중 보강구조



<B3>

ORDER NO.	0441-972
MODEL NO.	TB-CT-22
Ea. PRICE, ₩	18,700
규격(mm)	170×300
포장단위 Ea. / Pk.	1 / 4

다용도 공구집 (2구)

Lineman's Knife Pouch

- 칼날로 인한 스크래치 보호기능
- 전공칼 전용 파우치
- 러기드 형태로 제작
- 리벳용으로 제작되어 내구성우수



<B3>

ORDER NO.	0441-978
MODEL NO.	TB-CT-30-L
Ea. PRICE, ₩	17,640
규격(mm)	110×270
포장단위 Ea. / Pk.	1 / 5

다용도 공구집 (2구)

Hammer Holster

- 2개 홀더 및 포켓으로 구성
- 러기드 형태로 제작
- 작업시 사용 편리성 확보
- 리벳용으로 제작되어 내구성우수



<B3>

ORDER NO.	0441-979
MODEL NO.	TB-CT-31-A
Ea. PRICE, ₩	16,700
규격(mm)	120×250
포장단위 Ea. / Pk.	1 / 6

다용도 공구집 (6구)

Utility Pouch

- 6개 포켓 및 홀더로 구성
- 커터칼 전용 포켓
- 줄자 전용 클립
- 일반 반지주머니에 바로 장착가능



<B3>

ORDER NO.	0441-977
MODEL NO.	TB-30
Ea. PRICE, ₩	9,670
규격(mm)	80×210
포장단위 Ea. / Pk.	1 / 12

Articles

Cat. No

Description

다용도 공구집 (5구)

Tester Pouch

- 5개 포켓 및 홀더로 구성
- 테스터기 및 핸드폰 전용 파우치
- 낙하방지용 벨크로로 제작
- 러기드 형태로 제작

<B3>

ORDER NO.	0441-991
MODEL NO.	TB-CT-34-B
Ea. PRICE, ₩	21,640
규격(mm)	100×200
포장단위 Ea. / Pk.	1 / 4



다용도 공구집 (23구)

Supply Pouch

- 23개 포켓 및 홀더로 구성
- 1200 데니어 방탄섬유로 제작 되어 내구성이 우수
- 원터치 클립방식으로 탈부착이 간편하여 장착 시간이 단축됨
- 받침대 기능이 있어 내용물이 쉽게 쏟아지지 않음

<B3>

ORDER NO.	0434-591
MODEL NO.	TB-CT-01
Ea. PRICE, ₩	38,230
규격(mm)	280×350
포장단위 Ea. / Pk.	1 / 2



다용도 공구집 (9구)

Supply Pouch

- 9개 포켓 및 홀더로 구성
- 1200 데니어 방탄섬유로 제작 되어 내구성이 우수
- 원터치 클립방식으로 탈부착이 간편하여 장착 시간이 단축됨
- 받침대 기능이 있어 내용물이 쉽게 쏟아지지 않음

<B3>

ORDER NO.	0434-592
MODEL NO.	TB-CT-02
Ea. PRICE, ₩	41,160
규격(mm)	300×350
포장단위 Ea. / Pk.	1 / 2



다용도 공구집 (7구)

Supply Pouch

- 7개 포켓 및 홀더로 구성
- 1200 데니어 방탄섬유로 제작 되어 내구성이 우수
- 원터치 클립방식으로 탈부착이 간편하여 장착 시간이 단축됨
- 받침대 기능이 있어 내용물이 쉽게 쏟아지지 않음

<B3>

ORDER NO.	0434-593
MODEL NO.	TB-CT-03
Ea. PRICE, ₩	34,340
규격(mm)	260×400
포장단위 Ea. / Pk.	1 / 2



다용도 공구집 (12구)

Supply Pouch

- 12개 포켓 및 홀더로 구성
- 1200 데니어 방탄섬유로 제작 되어 내구성이 우수
- 원터치 클립방식으로 탈부착이 간편하여 장착 시간이 단축됨
- 받침대 기능이 있어 내용물이 쉽게 쏟아지지 않음

<B3>

ORDER NO.	0434-594
MODEL NO.	TB-CT-05
Ea. PRICE, ₩	24,580
규격(mm)	200×350
포장단위 Ea. / Pk.	1 / 2



다용도 공구집 (25구)

Master Electrician Pouch

- 받침대 기능이 있어 내용물이 쉽게 쏟아지지 않음
- 25개 포켓 및 홀더로 구성
- 다양한 제품 보관 가능

<B3>

ORDER NO.	0441-964
MODEL NO.	TB-CT-104
Ea. PRICE, ₩	64,800
규격(mm)	320×300
포장단위 Ea. / Pk.	1 / 2



다용도 공구집 (21구)

Electrician Pouch

- 21개의 포켓 및 홀더로 구성
- 드라이버, 후레쉬, 절연테이프, 줄자 보관용이
- 후레쉬라이트 보관기능

<B3>

ORDER NO.	0434-598
MODEL NO.	TB-CT-114
Ea. PRICE, ₩	53,980
규격(mm)	250×300
포장단위 Ea. / Pk.	1 / 2



다용도 공구집 (20구)

Service Pouch

- 20개 포켓 및 홀더로 구성
- 드라이버, 후레쉬, 절연테이프, 줄자 등 보관 용이
- 드라이버 홀더가 부착

<B3>

ORDER NO.	0441-966
MODEL NO.	TB-CT-106A
Ea. PRICE, ₩	48,100
규격(mm)	320×330
포장단위 Ea. / Pk.	1 / 2



다용도 공구집 (14구)

Plumber Pouch

- 받침대 기능이 있어 내용물이 쉽게 쏟아지지 않음
- 14개 포켓 및 홀더로 구성
- 배관공구용 제품 보관 용이

<B3>

ORDER NO.	MODEL NO.	PRICE, ₩ Ea.	규격(mm)	포장단위 Ea. / Pk.
0441-968	TB-CT-113	48,100	300×300	1 / 2



다용도 공구집 세트

Multi Pouch Set

- 강화 리벳방식
- 원터치 클립방식으로 탈부착 간편
- 받침대 기능이 있어 내용물이 쉽게 쏟아지지 않음

<B3>

ORDER NO.	0504-866
MODEL NO.	TB-CT-111-3
Ea. PRICE, ₩	82,960
포장단위 Ea. / Pk.	1 / 2



다용도 공구집 세트

Multi Pouch Set

- 커터칼 전용 포켓 줄자 전용 클립
- 원터치 클립방식으로 탈부착 간편
- 받침대 기능이 있어 내용물이 쉽게 쏟아지지 않음

<B3>

ORDER NO.	0504-867
MODEL NO.	TB-CT-111C
Ea. PRICE, ₩	66,050
포장단위 Ea. / Pk.	1 / 3



다용도 공구집 세트

Multi Pouch Set

- 줄자, 드라이버 전용 보관 포켓
- 원터치 클립방식으로 탈부착 간편
- 받침대 기능이 있어 내용물이 쉽게 쏟아지지 않음

<B3>

ORDER NO.	0504-868
MODEL NO.	TB-CT-101-5
Ea. PRICE, ₩	114,140
포장단위 Ea. / Pk.	1 / 2



다용도 공구집 세트

Multi Pouch Set

- 강화 리벳방식의 망치걸이
- 원터치 클립방식으로 탈부착 간편
- 받침대 기능이 있어 내용물이 쉽게 쏟아지지 않음

<B3>

ORDER NO.	0504-869
MODEL NO.	TB-CT-102-3
Ea. PRICE, ₩	60,700
포장단위 Ea. / Pk.	1 / 3



Articles

Cat. No

Description

다용도 공구집 (6구)

Multi Pouch

- 6개 포켓 및 홀더로 구성
- 줄자 및 기타 수공구 수납 용이
- 바지 주머니나 벨트위에 고정하기 용이

<B3>

ORDER NO.	0495-926
MODEL NO.	TB-23
Ea. PRICE, ₩	15,120
포장단위 Ea. / Pk.	1 / 6



다용도 공구집 (8구)

Multi Pouch

- 8개 포켓 및 홀더로 구성
- 카라비너 장착
- 1680 방탄섬유 재질로 내구성 우수

<B3>

ORDER NO.	0495-930
MODEL NO.	TB-222
Ea. PRICE, ₩	15,120
포장단위 Ea. / Pk.	1 / 6



다용도 공구집 (8구)

Multi Pouch

- 8개 포켓 및 홀더로 구성
- 1680 방탄섬유 재질로 내구성 우수
- 출자보관 포켓

<B3>

ORDER NO.	0495-929
MODEL NO.	TB-236-7
Ea. PRICE, ₩	19,010
포장단위 Ea. / Pk.	1 / 4



다용도 공구집 (11구)

Multi Pouch

- 11개 포켓 및 홀더로 구성
- 망치 및 못주머니 장착으로 효율성 증대
- 탈부착이 간편한 손쉬운 벨크로 타입

<B3>

ORDER NO.	0495-928
MODEL NO.	TB-228
Ea. PRICE, ₩	17,440
포장단위 Ea. / Pk.	1 / 4



다용도 공구집 (14구)

Multi Pouch

- 작업시 유용한 카라비너 장착
- 수직방향 공구 수납을 위한 멀티 주머니
- 1680 방탄섬유 재질로 내구성 우수

<B3>

ORDER NO.	0495-927
MODEL NO.	TB-229
Ea. PRICE, ₩	17,440
포장단위 Ea. / Pk.	1 / 6



다용도 공구집 (9구)

Multi Pouch

- 9개 포켓 및 홀더로 구성
- 단계적인 수납구조로 활용도가 높음
- 망치 및 못주머니 장착으로 작업시 유용

<B3>

ORDER NO.	0495-931
MODEL NO.	TB-201
Ea. PRICE, ₩	25,000
포장단위 Ea. / Pk.	1 / 3



다용도 공구집 (8구)

Multi Pouch

- 8개 포켓 및 홀더로 구성
- 스트랩과 버클로 드릴을 안전 고정
- 전동 드릴 전용 파우치

<B3>

ORDER NO.	0495-932
MODEL NO.	TB-220-B
Ea. PRICE, ₩	16,080
포장단위 Ea. / Pk.	1 / 6



다용도 공구집 (6구)

Multi Pouch

- 6개 포켓 및 홀더로 구성
- 기본 벨트 포함되어 간편
- 못주머니 전용 파우치

<B3>

ORDER NO.	0495-933
MODEL NO.	TB-310
Ea. PRICE, ₩	25,420
포장단위 Ea. / Pk.	1 / 4



Articles

Cat. No

Description

다용도 공구집 (20구)

Multi Pouch

- 20개 포켓 및 홀더로 구성
- 카라비너, 테이프 걸이 장착
- 수납공간이 많아 활용도가 높음



<B3>

ORDER NO.	0522-678
MODEL NO.	TB-316-2
Ea. PRICE, ₩	38,860
포장단위 Ea. / Pk.	1 / 4

어깨끈

Shoulder Strap

- 공구가방 전용 어깨끈
- 가방 고리에 장착
- 쿠션감이 있고 공기 순환 원활



<B3>

ORDER NO.	0444-355
MODEL NO.	TB-55-B
Ea. PRICE, ₩	9,670
포장단위 Ea. / Pk.	1 / 2

다용도 공구집 세트

Multi Pouch Set

- 1860 방탄섬유 재질로 우수한 내구성
- 여러개의 못주머니가 장착되어 있어 인테리어 작업시 유용
- 못주머니 2개, 망치걸이, 벨트



<B3>

ORDER NO.	MODEL NO.	PRICE, ₩ Ea.	포장단위 Ea. / Pk.
0504-874	TB-303-4	59,760	1 / 2

다용도 공구집 세트

Multi Pouch Set

- 1860 방탄섬유 재질로 우수한 내구성
- 여러개의 못주머니가 장착되어 있어 인테리어 작업시 유용
- 못주머니 2개, 줄자주머니, 벨트



<B3>

ORDER NO.	MODEL NO.	PRICE, ₩ Ea.	포장단위 Ea. / Pk.
0504-875	TB-304-4	41,060	1 / 2

다용도 공구집 세트

Multi Pouch Set

- 1860 방탄섬유 재질로 우수한 내구성
- 여러개의 못주머니가 장착되어 있어 인테리어 작업시 유용
- 못 주머니 2개, 줄자 주머니, 벨트, 엑스반도



<B3>

ORDER NO.	MODEL NO.	PRICE, ₩ Ea.	포장단위 Ea. / Pk.
0504-872	TB-301-6	104,380	1 / 2

다용도 공구집 세트

Multi Pouch Set

- 1860 방탄섬유 재질로 우수한 내구성
- 여러개의 못주머니가 장착되어 있어 인테리어 작업시 유용
- 못 주머니 2개, 줄자 주머니, 벨트, 엑스반도



<B3>

ORDER NO.	MODEL NO.	PRICE, ₩ Ea.	포장단위 Ea. / Pk.
0504-873	TB-303-6	75,820	1 / 2

Articles	Cat. No	Description
----------	---------	-------------



(1) Gun-type (2) Adapter-type

World® Polyurethane Foam, Spray · Gun-type for Sealing · Repair · Insulation, 750ml, 우레탄 폼

- **Made in Korea**
- 발포력 및 접착력이 우수하여 각종 틈새, 빈 공간 등을 메워주며 보온성, 단열성, 방음성 등이 뛰어나.
- * Main Component : PU(Polyurethane) * Various Gap Filling, Repairing, Insulation and Other Purposes
- * Excellent Self-extinguishing * Uniformity Foaming and Fast Vulcanization Speed, a Flame Retardant in Quality.
- * 40-60 Minutes Elapsed, the Fully Hardened Cutting is Possible
- * Various Finishing Operations are Possible on a Cutting Face.

(1) Gun-type Polyurethane Foam

DH.Foa3001 Foam, Gun-type, Polyurethane, 750ml

Ea.	Price, ₩	Cs.	Price, ₩
	4,630	15ea	

(2) Adapter-type Polyurethane Foam

DH.Foa3003 Foam, Spray-type, Polyurethane, 750ml

Ea.	Price, ₩	Cs.	Price, ₩
	4,630	15ea	

<B4>



(1) Gun-Type (2) Adapter-Type

Polyurethane Spray Foam, Gun · Adapter-type for Sealing · Repair · Insulation, 840ml, 우레탄 스프레이폼

- **Made in Korea**
- 내 · 외벽, 창호 주위 벽면 등 넓은 면을 한번에 시공하기에 적합
- * Main Component : PU(Polyurethane) * Excellent Self-extinguishing
- * Various Gap Filling, Repairing, Insulation and Other Purposes
- * Uniformity Foaming and Fast Vulcanization Speed, a Flame Retardant in Quality.
- * 40-60 Minutes Elapsed, the Fully Hardened Cutting is Possible

(1) Gun-type Polyurethane Foam

DH.Foa3006 Foam, Gun-type, Polyurethane, 840ml



분사노즐 (Gun-type용)

Ea.	Price, ₩	Cs.	Price, ₩
	8,340	15ea	

(2) Adapter-type Polyurethane Foam

DH.Foa3008 Foam, Spray-type, Polyurethane, 840ml

Ea.	Price, ₩	Cs.	Price, ₩
	8,340	15ea	

<B4>



TYTAN® Polyurethane Foam, Fire Class B1, Gun-type for Sealing · Repair · Insulation, 750ml, 우레탄 폼, 난연성

- **Made in Korea**
- 일액형 우레탄 폼 최고 수준의 난연성인 독일의 DIN 4102 Fire Class B1 규격을 충족
- 가스, 연기를 차단하거나 콘센트 등 화재 위험이 있는 곳에 적용
- * Main Component : PU(Polyurethane) * Good for Fire Retardant
- * Various Gap Filling, Repairing, Insulation and Other Purposes * Proper to Blocking Smoke and Gas
- * Uniformity Foaming and Fast Vulcanization Speed, a Flame Retardant in Quality.
- * 40-60 Minutes Elapsed, the Fully Hardened Cutting is Possible
- * Various Finishing Operations are Possible on a Cutting Face

DH.Foa3011 Foam, Gun-type Polyurethane, 750ml

Ea.	Price, ₩	Cs.	Price, ₩
	10,510	15ea	

<B4>

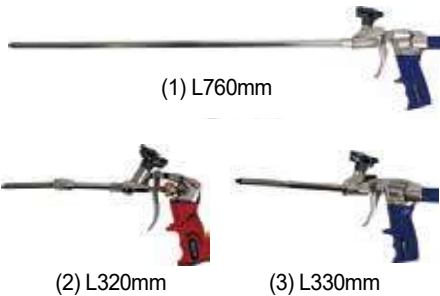

(1) L760mm

(2) L320mm

(3) L330mm

Foam Gun Dispenser, for Gun-type Polyurethane Foam & Foam Cleaner Length 330~760mm, 품건

- **Made in Korea**
- 손쉬운 잠금 스크류가 있어 폼 충전량을 쉽게 조절 가능
- * Gun-type be better Sophisticated and Convenient Operation than Spray-type
- * The ease of Use even for Beginner

DH.Gun7001 (1) Foam Gun Dispenser, Steel, L760mm, 517g
 DH.Gun7002 (2) , L320mm, 434g
 DH.Gun7003 (3) , L330mm, 363g

Ea.	Price, ₩	Cs.	Price, ₩
	32,910	20ea	
	23,110	20ea	
	15,400	20ea	

<B4>



World® Foam Cleaner, High Volatility, Good for Washing, 550ml, 폼 세척제, 고휘발성, 강력세척

- **Made in Korea**
- * Complete Removal of any Remaining Unhardened Foam
- * Useful Form-Gun(D15.DHP200) Cleaning
- * Caution : Flame may Cause the Product to Explode.

DH.Foa3015 Foam Cleaner, 550ml

Ea.	Price, ₩	Cs.	Price, ₩
	2,520	24ea	

<B4>

Wellz 인버터 용접기, Inverter Welding Machine

다국적



생산물배상책임보험 3억원 보험가입



사용동영상



- 4φ 풀 용접 가능
- 출력 수치 디지털 표시
- 과부하 방지 기능 내장

<B3>

[구성품]

구 분	내 용			구 분	내 용	
정 격 입력	9.6 KVA			제 어 방식	국산 IGBT INVERTER	
출 력 전 류	20~230 A			무 게	4.2 kg	
용 접 능 력	1.6~5.0φ			크 기	265×117×190 mm	

ORDER NO.	MODEL NO.	PRICE, ₩ Ea.	포장단위 Ea. / Pk.
0503-969	WWM-230	220,510	1 / 4

Wellz 논가스 용접기, Mig Welding Machine

다국적



생산물배상책임보험 3억원 보험가입



사용동영상



- 아크용접 가능
- 정지하지 않고 장시간 가스없이 사용가능
- 출력 수치 디지털 표시
- 과부하 방지 기능 내장

<B3>

[구성품]

구 분	내 용			구 분	내 용		
정 격 입력	7.8 KVA			제 어 방식	국산 IGBT INVERTER		
출 력 전 류	50~200 A			무 게	9.8kg		
용 접 능 력	[CO ₂] 0.6~1.0φ/[MMA] 1.6~3.2φ			크 기	490×210×330mm		

ORDER NO.	MODEL NO.	PRICE, ₩ Ea.	포장단위 Ea.
0519-043	WNG-200	441,000	1

Wellz 논가스 용접기용, Mig Wire

다국적

생산물배상책임보험 3억원 보험가입

AWS : E71T-GS



- 용접 후 슬래그 없음
- Wire 굵기 : φ0.9mm
- 1롤 ; 5kg

<B3>

ORDER NO.	MODEL NO.	PRICE, ₩ Ea.	포장단위 Ea.
0522-259	WNW-200	52,510	1

PTN 인버터 DC(직류)아크 용접기, Inverter DC ARC Welding Machine

KOREA



ISO 9001



◀ (1) PTN-160DS

130A & 160A형, φ2.6 & φ3.2 용접봉용

- 자율 안전 인증품
- 전격방지기 자동설정 외부 푸시버튼으로 (ON/OFF) 설정 및 해제
- 150~250V(입력전압)에서도 정상 작동
- 릴선 100M 이상(입력전선) 사용 가능
- 아연강판 케이스로 부식 방지

본체 PRICE

<B3>



ORDER NO.	MODEL NO.	PRICE, ₩	입력전압 (V)	출력전류 (A)	정격입력 (kW)	용접봉 (φ)	중량 (kg)	외형치수(mm) (W×D×H)
▶ 0320-296	PTN-160DS	242,960	1P 220	130	3.3	2.6F	7	180×330×210
▶ 0320-297	PTN-180DS	276,720	1P 220	160	4.2	3.2F	7.3	180×330×210

Articles	Cat. No	Description
----------	---------	-------------



◀ PTN-500LP

인버터 DC 알곤용접기, Inverter DC TIG Welding Machine KOREA

- 전문가용으로 설계된 특수한 장비
- 리모콘 원격제어 (별매품)
- 업/다운 슬로프 개별 조절
- IGBT 인버터 방식
- 직류 펄스 기능
- 저전압 안정 장치 탑재

본체 PRICE <B3>

ORDER NO.	MODEL NO.	PRICE, ₩	입력전압 (V)	출력전류 (A)	정격입력 (kW)	중량 (kg)	외형치수(mm) (W×D×H)
0347-207	PTN-350GP	905,180	1P 220	350	7.5	19.5	235×470×370
0320-315	PTN-350LP	1,055,260	1, 3P	350	7.5	21	235×470×370
▶ 0320-316	PTN-500LP	1,583,350	220~440	500	12.5	40	300×620×580





(1) PTN-301AD



◀ (2) PTN-500AD2

인버터 AC/DC 알곤용접기, Inverter AC/DC TIG Welding Machine KOREA

(1) 220A 표준형

- 가정용 전원으로 용접가능
- 직류 펄스 주파수 조절기능
- 국내 경량 초소형
- 크레이터 제거기능
- 교류 주파수 조절가능
- 철, 스테인리스, 알루미늄, 합금 등 모든 금속 용접
- 크리닝 조절기능

본체 PRICE <B3>

ORDER NO.	MODEL NO.	PRICE, ₩	입력전압 (V)	출력전류 (A)	정격입력 (kW)	중량 (kg)	외형치수(mm) (W×D×H)
0320-320	PTN-301AD	1,510,190	1P 220	220	4.5	25	180×400×250

(2) 350A & 500A 전문가용 대용량

- 중후판 알루미늄 용접가능
- 크레이터 1회 반복, 크리닝 제어
- 입력전압 220~440V검용
- AC/DC 복합
- 업 다운 슬로프 기능
- 토치 케이블 50M 가능
- 직류/교류 펄스 주파수 조절
- 리모콘 원격제어 (별매품)



본체 PRICE <B3>

ORDER NO.	MODEL NO.	PRICE, ₩	입력전압 (V)	출력전류 (A)	정격입력 (kW)	중량 (kg)	외형치수(mm) (W×D×H)
0320-321	PTN-350AD2	2,035,470	1, 3P, 220~440	350	8.7	41	300×620×580
▶ 0320-322	PTN-500AD2	2,412,540	1, 3P, 220~440	500	12.5	47	300×620×580

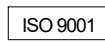

◀ PTN-501S

인버터 CO₂ 아크용접기, Inverter CO₂/MAG/MIG ARC Welding Machine KOREA

- IGBT 인버터 방식으로 소형 경량화
- 기존 SCR 방식의 용접기 대체
- 단상/삼상 220~440V 공용
- 연장 케이블 30M 가능
- 박판에서 중후판까지 용접 가능

본체 PRICE <B3>

ORDER NO.	MODEL NO.	PRICE, ₩	입력전압 (V)	출력전류 (A)	정격입력 (kW)	중량 (kg)	외형치수(mm) (W×D×H)
0320-317	PTN-352S+	984,910	1P 220	250	7.5	21	235×470×370
0320-318	PTN-351S+	1,463,280	1, 3P	350	12.6	41	300×620×580
▶ 0320-319	PTN-501S+	1,660,270	220~440	500	22.5	45	300×620×580



▲ PTN-4500

포터블 스폿 용접기, Portable Spot Welding Machine KOREA



- 차량 판금용으로 간편 조작
- 0.5mm이하에서 스폿트 용접
- 전압 조절 기능/용접시간 자동 설정
- 스테인리스 난간 용접

※ 세트 PRICE(건 : 2M, 어스 : 1.8M)

본체 PRICE <B3>

ORDER NO.	MODEL NO.	PRICE, ₩	입력전압 (V)	출력전류 (A)	정격입력 (kW)	중량 (kg)	외형치수(mm) (W×D×H)
▶ 0320-323	PTN - 4500	979,280	1P 220	3	0.4	19	180×350×200
0320-757	PTN - 7500	1,247,550	1P 220	5	0.7	37	350×300×700

PTN 인버터 에어 플라즈마 절단기, Inverter Air Plasma Cutting Machine KOREA ISO 9001



▲ (1) PTN-35P

(1) 콤프레사 내장형

- 콤프레사 내장형으로 별도의 에어가 필요 없음
- 철, 스테인리스 등 모든 금속 절단
- 가정용 전원으로도 절단 가능 : 19A소요(PTN-35P)
- 절단 토치 최대 30M 가능
- 과전압 방지 장치 장착(PTN-61P)으로 발전기 사용 가능

본체 PRICE <B3>

ORDER NO.	MODEL NO.	PRICE, ₩	출력전류 (A)	정격입력 (kW)	절단능력(T) (적정/최대)	중량 (kg)	외형치수(mm) (W×D×H)
▶ 0320-302	PTN-35P	1,163,120	35	3.5	4/8	20	180×420×330
0320-303	PTN-60P	1,510,190	60	8.4	8/15	25	235×430×370
0320-304	PTN-61P	1,782,200	60	8.4	8/15	26	235×430×370



▲ (2) PTN-70SP

(2) 콤프레사 외장형

- 두께 5mm 이상의 금속을 고속으로 깨끗하게 절단
- 아연 강판 케이스로 부식 방지
- 녹슬거나 페인트칠한 금속도 절단
- 입력전압 PTN-70SP 1P 220V

※ 콤프레사 공업용 2HP 이상 사용

본체 PRICE

ORDER NO.	MODEL NO.	PRICE, ₩	출력전류 (A)	정격입력 (kW)	절단능력(T) (적정/최대)	중량 (kg)	외형치수(mm) (W×D×H)
▶ 0320-306	PTN-70SP	905,180	60	7.2	7/15	16	190×450×280
0320-309	PTN-100PD	1,735,310	100	14	15/30	40	300×620×580
0320-311	PTN-130PD	1,960,430	130	18.2	20/40	45	300×620×580
0320-312	PTN-150PD	2,335,630	150	21	25/50	50	300×620×580

KSU PVC 용접기, PVC Welding Machine KOREA ISO 9001



- 전자 구동식 격판 송풍기를 채용하여 토출 구조가 간단함
- 소모부품을 간소화하여 고장이 적고 장시간 연속 사용에도 내구성이 뛰어나



<B3>

ORDER NO.	MODEL NO.	PRICE, ₩	세트구성
0336-586	KSU-W-80	794,590	본체, 용접기건, 용접히터

KSU PPC 용접기 (용착기), PPC Pipe Welding Machine KOREA



- 파이프와 이음관 연결에 사용
- 250℃ 고열로 순간 확장하여 연결
- 온수 난방용, 스프링쿨러, 공업용 용수, 배관등



▲ PPC-WDL

<B3>

ORDER NO.	MODEL NO.	PRICE, ₩	규격(φ)	세트구성
0369-355	PPC-WDS	245,700	15~50	본체, 소켓 (15, 20, 25, 30, 40, 50)
▶ 0369-356	PPC-WDL	331,350	15~65	본체, 소켓 (15, 20, 25, 30, 40, 50, 65)

Wellz 가스절단기 토치, Cutting Torch 다국적

생산물배상책임보험 3억원 보험가입



▲ SWT-101

<B3>

ORDER NO.	MODEL NO.	PRICE, ₩ Ea.	규격	전장(mm)	포장단위 Ea. / Cs.
▶ 0284-075	SWT-101	19,480	중형	450	1 / 35
0299-089	SWT-201	27,390	대형	550	1 / 25
0307-296	SWT-301	28,120	장대형	630	1 / 20

Wellz 가스용접기 토치, Welding Torch 다국적



▲ SWT-102

<B3>

ORDER NO.	MODEL NO.	PRICE, ₩ Ea.	규격	전장(mm)	포장단위 Ea. / Cs.
▶ 0284-076	SWT-102	16,940	소형	400	1 / 20
0299-088	SWT-202	19,020	중형	450	1 / 20

Articles Cat. No Description

가스용접기 토치, Gas Welding Torch KOREA

(1) Mini형



▲ DK-100

(2) Mid형



▲ DK-102

<B3>

ORDER NO.	MODEL NO.	PRICE, ₩ Ea.	전장(mm)	포장단위 Ea. / Cs.
0307-713	DK-100	40,090	300	1 / 70

ORDER NO.	MODEL NO.	PRICE, ₩ Ea.	전장(mm)	포장단위 Ea. / Cs.
0307-715	DK-102	38,620	430	1 / 40
0455-405	DK-102	42,340	480	1 / 40

Wellz 절단화구 (LPG/AC), Cutting Torch Tip 다국적

(1) LPG ▶



(2) AC ▶
(아세틸렌)



적힘 방지용 고무캡

생산물배상책임보험 3억원 보험가입

- 화구 번호가 클수록 화구 고압 분출 홀은 커짐
- 고무 캡 제거 후 사용

<B3>

ORDER NO.	타입	PRICE, ₩ Ea.	규격	포장단위 Ea. / Pk.
▶ 0299-092			대형 #1	
0299-091	(1) LPG	3,400	대형 #2	1 / 10
0299-090			대형 #3	
▶ 0284-084	(2) AC	2,560	중형 #2	1 / 10

가스용접기 자동절단화구(LPG용), Auto Gas Cutting Torch Tip 다국적



▶ LPG용



- 자동가스절단기, 중앙절단기 전용으로 사용하는 절단화구
- 절단할 모재의 두께(+)에 따라 번호선택

<B3>

ORDER NO.	MODEL NO.	PRICE, ₩ Ea.	규격	포장단위 Ea. / Pk.
0307-835			#0	
0307-836			#1	
0307-837	DK-601T	12,830	#2	1 / 10
0307-839			#3	
0307-841			#4	
0307-840		12,830	#5	
0307-838	DK-601T	12,830	#6	1 / 10
0307-787		14,220	#7	
0307-788		14,220	#8	

Wellz 가스 조절기, Gas Regulator of O₂/LPG/AC 다국적

생산물배상책임보험 3억원 보험가입



(1) 산소조절기(OX)



(2) 프로판조절기(LPG)

가스안전공사 인증제품



(3) 아세틸렌조절기(AC)

<B3>

ORDER NO.	MODEL NO.	품명	PRICE, ₩ Ea.	1차 압력		포장단위 Ea. / Cs.
				2차 압력	kgf/cm ²	
(1) 0284-077	SWR - 101	산소조절기(OX)	20,030	250	25	
(2) 0284-078	SWR - 102	프로판조절기(LPG)	16,390	-	3	1 / 24
(3) 0284-079	SWR - 103	아세틸렌조절기(AC)	20,940	25	3	

Wellz 가스 조절기, Gas Regulator of AR/N₂/CO₂ 다국적



(1) 알곤조절기(AR)



(2) 질소조절기(N₂)



(3) 이산화탄소조절기(CO₂)

<B3>

ORDER NO.	MODEL NO.	품명	PRICE, ₩ Ea.	1차 압력		2차 압력		포장단위 Ea. / Cs.
				kgf/cm ²		kgf/cm ²		
(1) 0284-080	SWR-104	알곤조절기(AR)	21,840	250		-		1 / 18
(2) 0299-164	SWR-105	질소조절기(N ₂)	29,120	250		10		1 / 18
(3) 0348-187	SWR-106A(110V / 22mm)	이산화탄소조절기(CO ₂)	46,420	-		6		1 / 12
0348-190	SWR-106B(220V / 22mm)							
0385-099	SWR-107A(110V / 23mm)							
0385-101	SWR-107B(220V / 23mm)							

Wellz 가스 역화 방지기, Gas Flashback Arrestor 다국적



생산물배상책임보험 3억원 보험가입

<B3>

ORDER NO.	MODEL NO.	PRICE, ₩ Ea.	타입	포장단위 Ea. / Cs.
0284-207	DS-100	13,660	LPG, AC	1 / 50

가스 조절기 부품(CO₂, OX), Parts for Gas Regulator

KOREA



ISO 9001



<B3>

ORDER NO.	품명	PRICE, ₩ Ea.	규격	포장단위 Ea. / Cs.
① 0472-854	호스닛뿔(공용)	-	-	-
② 0472-853	CO ₂ , OX호스너트	1,480	M16×1.5	1 / 5
③ 0307-820	OX조절기이음대	-	-	-
④ 0307-828	OX장나사	2,950	59mm	1 / 5
⑤ 0307-825	CO ₂ , OX장나사너트	3,130	23mm	1 / 5

KISWEL 용접 연강봉, Welding Electrode for Mild Steel

KOREA



ISO 9001 / ISO 14001

AWS: E6013 / KS: E4313 / JIS: E4313



<B3>

ORDER NO.	MODEL NO.	규격(φ)	PRICE, ₩ Pk.	포장단위 Pk. / Cs.
0361-290	KR-3000	2.6	17,310	5kg / 20kg
0361-291		3.2	16,890	
0361-292		4.0	16,470	

- 용접 작업성이 아주 우수한 고산화티탄계
- 재아크 발생이 용이하고 슬래그가 자연 박리되므로 중, 후판 구조물의 화장 용접용으로도 사용가능
- 박강판, 파이프, 경량 형강의 용접 및 일반 구조물의 화장 용접용

제품 수치 및 용접 전류범위(AC 또는 DC ⊕)

전류범위 (A)	하향 입 · 상향	0.675pt				
		2.6	3.2	4.0	5.0	6.0
봉장(mm)		350	350	400	400	450
전류범위 (A)	하향	60~100	80~130	130~180	160~220	210~280
	입 · 상향	60~90	80~120	90~140	120~190	-

Articles	Cat. No	Description
----------	---------	-------------

KISWEL 용접 고장력봉, Welding Electrode for Hi-Tensile Steel

KOREA

AWS : E7016 / KS : E5016 / JIS : E4916



<B3>

- 확산성 수소량이 낮고 용착 금속의 내균열성, 기계적 성질 및 X-ray 성능이 우수한 저수소계 용접봉
- 우수한 용접 작업성과 슬래그 박리성, 언더컷 발생이 없음
- 교량, 선박, 압력용기 등에 사용되는 50kgf/mm²급 고장력강

ORDER NO.	MODEL NO.	규격(φ)	PRICE, ₩ Pk.	포장단위 Pk. / Cs.
0362-557		2.6	24,070	
0362-558	KK-50LF	3.2	23,370	5kg / 20kg
0362-559		4.0	22,660	

KISWEL 스테인레스 용접 아크봉, Welding Electrode for Stainless-steel

KOREA



(1) KST-308 아크봉

AWS : E308-16 / KS : E308-16 / JIS : ES308-16



(1) KST-308 아크봉

- AISI(Stainless-steel) 304 Stainless-steel강의 용접, 라임티타니아계 18%Cr-8%Ni 스테인레스 용접봉

<B3>

ORDER NO.	MODEL NO.	규격(φ)	PRICE, ₩ Pk.	포장단위 Pk. / Cs.
(1) 0363-835		2.6	58,640	
0363-837	KST-308	3.2	57,230	5kg / 20kg
0364-085		4.0	56,760	

(2) KST-309 아크봉

AWS : E309-16 / KS : E309-16 / JIS : ES309-16



(2) KST-309 아크봉

- Stainless-steel 304계 클레이드강의 클레드면 용접

ORDER NO.	MODEL NO.	규격(φ)	PRICE, ₩ Pk.	포장단위 Pk. / Cs.
(2) 0364-080		2.6	76,690	
0364-077	KST-309	3.2	75,520	5kg / 20kg
0364-079		4.0	74,590	

(3) KST-316 & 316L 아크봉

AWS : E316L-16 / KS : E316L-16 / JIS : ES316L-16



(3) KST-316 & 316L 아크봉

- AIS(SIS) 316의 용접 라임티타니아계 18%Cr-12%Ni-2%Mo 스테인레스 고온에서 내산화성
- KST-316L은 -316과 동일하나, 특히 용체화 처리가 불가능한 곳의 용접

ORDER NO.	MODEL NO.	규격(φ)	PRICE, ₩ Pk.	포장단위 Pk. / Cs.
(3) 0364-081		2.6	79,740	
0364-082	KST-316	3.2	78,340	5kg / 20kg
0364-083		4.0	77,400	
▶ 0364-275	KST-316L	2.6	86,770	5kg / 20kg
0364-276		3.2	85,370	

HYUNDAI 스테인레스 용접 아크봉, Welding Electrode for Stainless-steel

KOREA



▲ S-308.16N

<B3>

ORDER NO.	MODEL NO.	규격(φ)	PRICE, ₩ Pk.	포장단위 Pk. / Cs.
▶ 0319-472		2.6	65,440	
0319-473	S-308.16N	3.2	63,790	5kg / 20kg
0319-453		4.0	62,860	
0319-881		2.6	101,310	
0319-882	S-309L.16	3.2	99,910	5kg / 20kg
0319-883		4.0	98,970	

모델	S-308.16N	S-309.16N	S-316.16N
AWS	E308-16	E309-16	E316-16
재질	18%Cr-8%Ni	22%Cr-12%Ni	18%Cr-12%Ni
	SS 304 스테인리스 강용	SS 309 스테인리스 강용, 탄소강과 연강의 접합용	SS 316 스테인리스 강용

ORDER NO.	MODEL NO.	규격(φ)	PRICE, ₩ Pk.	포장단위 Pk. / Cs.
0319-568		2.6	98,500	
0319-569	S-316.16N	3.2	96,630	5kg / 20kg
0319-570		4.0	96,160	
0319-886	S-316L.16N	2.6	106,470	5kg / 20kg
0319-887		3.2	105,060	

HYUNDAI CO₂ 솔리드 와이어, Solid Wire for CO₂ Gas Welding

KOREA



- 조선, 차량, 교량, 건축, 철골구조물 등의 맞대기 및 필렛 용접
- 솔리드 와이어로 용착 속도가 대단히 크고, 용입이 깊으므로 고능률의 용접이 가능

AWS : ER70S-6 / KS : YGW12 / JIS : YGW12

<B3>

ORDER NO.	MODEL NO.	규격(φ)	PRICE, ₩	포장단위 Cs.
0319-456		0.9	75,040	20kg
0319-457	SM-70	1.0	71,290	
0319-446		1.2	69,420	
0319-458		1.4		

HYUNDAI CO₂ 플렉스 코드 와이어, Flux Cored Wire for CO₂

KOREA

SF-71 ▼



- 전 자세 용접 가능
- CO₂ 솔리드 와이어에 비해 아크가 안정적
- 슬래그 박리성이 양호하며 내균열성 우수
- 비드 외관 및 퍼짐성이 우수
- 조선, 차량, 교량, 건축, 철골구조물 등의 맞대기 및 필렛 용접

AWS : E71T-1C / KS : YFW-C50DR / JIS : T49J0 T1-1 CA-UH10

<B3>

ORDER NO.	MODEL NO.	규격(φ)	PRICE, ₩	포장단위 Cs.
▶ 0319-443		1.2		15kg
0319-444	SF-71	1.4	51,080	
0319-445		1.6		

HYUNDAI 스테인레스 플렉스 코드 와이어, Flux Cored Wire for Stainless-steel

KOREA

SW-308L ▼



- SW-308L** : 석유, 약품, 비료, 섬유 등의 화학공업에 위한 18%Cr-8%Ni강 및 저탄소 18%Cr-8%Ni 강용접
- SW-309L** : 스테인레스 크래드강의 밀갈기, 스테인레스 강과 탄소강 또는 저합금강의 이종금속용접
- SW-316L** : 각종 석유 및 화학공업용 등에 사용되는 18%Cr-12%Ni-2%Mo 및 저탄소 18%Cr-12%Ni-2%Mo계 스테인레스강 용접

AWS : E308LT1-1/4 / JIS : TS308L-FB1

<B3>

ORDER NO.	MODEL NO.	규격(φ)	PRICE, ₩	포장단위 Cs.
▶ 0319-452	SW-308L	1.2	301,110	15kg
0319-470	SW-308L	1.6	301,110	15kg
0319-836	SW-309L	1.2	372,860	15kg
0319-837	SW-309L	1.6	327,840	15kg
0319-838	SW-316L	1.2	344,730	15kg
0319-839	SW-316L	1.6	327,840	15kg

KISWEL 스틸 티그봉, TIG Wire for Steel

KOREA

AWS : ER70S-6 / KS : YGT150 / JIS : W 49A 3U 6

T-50 ▶



- T-50** ■ AWS : ER70S-6 / 연강 및 50kgf/mm²급 고장력강 용접
- T-50G** ■ AWS : ER70S-G / 연강 및 50kgf/mm²급 고장력강 용접
- T-53** ■ AWS : ER70S-3 / 연강 및 50kgf/mm²급 고장력강 용접

포장단위 5kg

<B3>

MODEL NO.	φ1.2		φ1.6		φ2.0		φ2.4		φ3.2	
	ORDER NO.	PRICE, ₩	ORDER NO.	PRICE, ₩	ORDER NO.	PRICE, ₩	ORDER NO.	PRICE, ₩	ORDER NO.	PRICE, ₩
T-50	▶ 0364-482	26,370	0361-960	23,550	0361-858	22,520	0361-859	21,500	0361-957	21,500
T-50G	0375-360	29,330	0375-363	26,460	0375-365	25,380	0375-367	24,400	0375-368	24,400
T-53	0375-382	28,340	0375-383	25,470	0375-384	24,440	0375-385	23,460	0375-388	23,460

KISWEL 스테인레스 티그봉, TIG Wire for Stainless-steel

KOREA

AWS : ER308 / KS : STSY 308 / JIS : YS308

(1) T-308 ▶



- 스테인리스강 중에서 가장 일반적으로 사용되는 SS-304스테인리스 강용 용접
- T-308** : 석유화학, 담수공사, 약품, 비료, 섬유 등에 사용
- T-308L** : 원자력, 석유화학, 플랜트에 사용되는 저탄소 용접

포장단위 5kg

<B3>

MODEL NO.	φ1.2		φ1.6		φ2.0		φ2.4		φ3.2	
	ORDER NO.	PRICE, ₩	ORDER NO.	PRICE, ₩	ORDER NO.	PRICE, ₩	ORDER NO.	PRICE, ₩	ORDER NO.	PRICE, ₩
T-308	▶ 0364-564	78,100	0361-962	76,690	0361-963	75,520	0361-965	74,120	0361-966	72,700
T-308L	0375-413	92,400	0361-959	90,990	0361-855	89,590	0361-856	88,180	0361-857	86,770

<Continued On Next Page>

Articles	Cat. No	Description
----------	---------	-------------

<Continued From... 스텐레스 티그봉, TIG Wire for Stainless-steel>

AWS : ER309 / KS : STSY 309 / JIS : YS309

(2) T-309 ▶



- 석유화학, 섬유공업 등에 사용되는 22%Cr-12%Ni (AISI(SS 309)), 오스테나이트계 스텐리스 강 용접재료
- 스텐리스강과 탄소강의 이재용접
- 스텐리스 클레드강의 밀깎기 용접

포장단위 5kg <B3>

MODEL NO.	φ1.2		φ1.6		φ2.0		φ2.4		φ3.2	
	ORDER NO.	PRICE, ₩	ORDER NO.	PRICE, ₩	ORDER NO.	PRICE, ₩	ORDER NO.	PRICE, ₩	ORDER NO.	PRICE, ₩
T-309	▶ 0364-704	105,530	0375-419	104,130	0375-423	102,480	0363-001	101,080	0363-000	99,670
T-309L	0375-428	120,790	0375-429	119,370	0375-430	117,960	0375-432	116,560	0375-434	115,150

AWS : ER316 / KS : STSY 316 / JIS : YS316

(3) T-316 ▶



T-316

- 저탄소 18%Cr-12%Ni-2% Mo, 오스테나이트 스텐리스강 용접

포장단위 5kg <B3>

MODEL NO.	φ1.2		φ1.6		φ2.0		φ2.4		φ3.2	
	ORDER NO.	PRICE, ₩	ORDER NO.	PRICE, ₩	ORDER NO.	PRICE, ₩	ORDER NO.	PRICE, ₩	ORDER NO.	PRICE, ₩
T-316	▶ 0375-283	112,810	0375-285	111,400	0375-286	109,990	0375-287	108,590	0375-288	107,180
T-316L	0375-293	120,790	0366-686	119,370	0366-687	117,960	0364-551	116,560	0364-549	115,150

연강 가스 용접봉, Gas Welding Rod

KOREA



ISO 9001 / ISO 14001

AWS : R45 / KS : GA46 / JIS : GA46



- 용용성이 좋고 용착이 용이 ■ 연강용 산소-아세틸렌 가스 용접 ■ 사양 - 길이 : 1,000mm
- 용착 금속에 비금속재료를 등 불순물이 적어 양호한 용접부를 갖음

용착금속의 화학성분 일례 (%)

포장단위 5kg <B3>

C	Si	Mn	P	S
0.04	0.02	0.45	0.013	0.010

MODEL NO.	φ1.6		φ2.0		φ2.4		φ3.2		φ4.0	
	ORDER NO.	PRICE, ₩	ORDER NO.	PRICE, ₩	ORDER NO.	PRICE, ₩	ORDER NO.	PRICE, ₩	ORDER NO.	PRICE, ₩
T-40	0375-439	23,840	0375-440	22,340	0375-441	20,930	0375-442	20,930	0375-443	20,930

용접 은납봉 0.5% Bcup-30SH
Welding, Silver Brazing Rod

KOREA



ISO 9001



- 은납봉 3% 대비 유동성 및 용입은 비슷하나 경제적인
- 동 및 동합금의 용접에 사용
- 진동이 심한 경우 Bcup-3(5%) 사용할 것

<B3>

ORDER NO.	규격(φ)	Pk. PRICE, ₩	재질	포장단위 Pk. / Cs.
0377-083	1.6	180,320	AG 3% 대용품	5kg / 20kg
0377-085	2.0	175,430		
0376-990	2.4	168,560		
0376-991	3.2	168,560		

용접 은납봉 3% Bcup-3S
Welding, Silver Brazing Rod

KOREA



ISO 9001



- Cu-P-Ag(2.8~3.2%) 3원 합금임
- 은을 첨가하여 가공성, 전연성, 퍼짐성 좋음
- 직접, 간접 용접이 용이함
- 전기부품, 열교환기, 난방용, 동배관용접

<B3>

ORDER NO.	규격(φ)	Pk. PRICE, ₩	재질	포장단위 Pk. / Cs.
0377-079	1.6	362,600	AG : 3%	5kg / 20kg
0377-080	2.0	322,430		
0376-983	2.4	392,000		
0376-984	3.2	296,950		

용접 은납봉 5% Bcup-3
Welding, Silver Brazing Rod

KOREA



ISO 9001



- Cu-P-Ag(4.8~5.2%) 3원 합금임
- 직접, 간접 용접이 용이함
- 은을 첨가하여 가공성, 전연성, 퍼짐성 좋음
- 전기부품, 열교환기, 난방용, 동배관용접

<B3>

ORDER NO.	규격(φ)	Pk. PRICE, ₩	재질	포장단위 Pk. / Cs.
0377-081	1.6	556,160	AG : 5%	5kg / 20kg
0377-082	2.0	460,600		
0376-981	2.4	583,110		
0376-982	3.2	583,110		

용접 은납봉 15% Bcup-5
Welding, Silver Brazing Rod

KOREA



ISO 9001



- 동 및 동합금의 용접

<B3>

ORDER NO.	규격(φ)	Pk. PRICE, ₩	재질	포장단위 Pk. / Cs.
0519-363	1.6	1,215,200	AG 15%	5kg / 20kg
0519-364	2.0	1,210,310		
0519-365	2.4	1,205,400		
0519-366	3.2	1,205,400		

Wellz 용접 텅스텐봉, Welding Tungsten Electrode

KOREA

용접 텅스텐봉의 종류

구분	명칭	봉단색	및 특성	첨가물
토륨 텅스텐	WT-20	적색 (RED)	일반적으로 가장 광범위하게 사용됨	Torium 2.0%
란탄 텅스텐	WL-15	금색 (GOLD)	인체 무해한 재질로 토륨을 대체하고 모든 강종에 사용하며 알루미늄 용접에 좋음	Lanthan 1.5%
세륨 텅스텐	WC-20	회색 (GRAY)	DC, 저전류에 특성이 좋아 정밀 금형에 널리 사용됨	Cerium 2.0%
순 텅스텐	W-PURE	녹색 (GREEN)	순텅스텐 전극봉으로 알루미늄 용접에 주로 사용되며 연마없이 사용됨	Pure-Tungsten
지르코늄 텅스텐	WZ-8	백색 (WHITE)	AC 고전류에 주로 사용되며 알루미늄 및 자동차 용접용으로 적합함	Zirconium 0.8%

(1) "WT20-토륨" 텅스텐봉, 적색팁



ORDER NO.	규격(φ×mm)	Pk. PRICE, ₩	포장단위 Pk. / Cs.
0263-636	1.6×150	8,480	10 / 100
0260-695	2.0×150	12,750	
0260-696	2.4×150	16,670	
0260-697	3.2×150	30,040	

(2) "WL15-란탄" 텅스텐봉, 금색팁



ORDER NO.	규격(φ×mm)	Pk. PRICE, ₩	포장단위 Pk. / Cs.
0319-083	1.6×150	9,110	10 / 100
0319-715	2.0×150	14,120	
0319-716	2.4×150	20,390	
0319-085	3.2×150	36,400	

(3) "WP-순" 텅스텐봉, 녹색팁



ORDER NO.	규격(φ×mm)	Pk. PRICE, ₩	포장단위 Pk. / Cs.
0319-084	2.4×150	19,120	10 / 100
0319-717	3.2×150	33,680	10 / 100

(4) "WTH20-토륨" 텅스텐봉, 적색팁



ORDER NO.	규격(φ×mm)	Pk. PRICE, ₩	포장단위 Pk. / Cs.
0109-347	1.6×150	57,120	10 / 100
0109-348	2.0×150	85,680	
0109-349	2.4×150	109,480	
0109-350	3.2×150	190,400	
0144-241	8.0×150	1,032,920	

Wellz 봉사, 산소용접, Borax

KOREA



▲ 300g

▲ 500g

■ 산소 용접시 용접부위 산화물을 제거하여 용접 품질을 향상

<B3>

ORDER NO.	용량(g)	Ea. PRICE, ₩	포장단위 Ea. / Cs.
▶ 0401-462	300	2,630	1 / 13
▶ 0401-771	500	3,880	1 / 8

YUHAN PVC 용접봉, PVC Rod

KOREA



ISO 9001

- PVC판, 파이프의 이음부 파열된 부분 보수
- 길이 : 1,200mm

<B3>

ORDER NO.	규격(φ)	Pk. PRICE, ₩	색상	포장단위 Pk. / Cs.
0376-054	2.5	61,750	회색	1kg / 10kg
0376-055	2.5		아이보리	
0376-057	3.0		회색	
0376-056	3.0	아이보리		



▼ JHE-5KG

TJM 휴대용 용접봉 건조기, Portable Welding Rod Oven

KOREA

- 온도 조절식 : R/T ± 5℃~200℃
- 230V, 50/60Hz



<B3>

ORDER NO.	MODEL NO.	Ea. PRICE, ₩	타입	입력전압(V)	용량(kg)	포장단위 Ea. / Cs.
▶ 0321-205	JHE - 5KG	57,340	일반형	1P 220	5	1 / 10
0321-209	JHE - 5KB	80,360	온도조절형		5	
0321-213	JHE - 10KB	99,960	온도조절형		10	

Articles	Cat. No	Description
----------	---------	-------------

Wellz 용접봉 홀더, Welding Electrode Holder 다국적

KEH-400A ▶



■ 재질 : 철 〈B3〉

ORDER NO.	MODEL NO.	PRICE, ₩ Ea.	포장단위 Ea. / Cs.
▶ 0336-215	KEH-400A	2,920	1 / 50
0336-216	KEH-600A	3,360	1 / 50

Wellz 용접 아크잭, Welding Cable Joint 다국적

160A ▶



▲ 구성품

■ 높은 전도성과 안정성 〈B3〉

ORDER NO.	MODEL NO.	PRICE, ₩ Ea.	규격	포장단위 Ea. / Cs.
▶ 0340-519	160A	3,010	小	1 / 50
0340-521	200A	6,930	大	1 / 25

Dj 어스클램프, Earth Clamp, 50A · 100A · 200A 다국적



50A
100A
200A

ST200A(A급)

■ 점프선 제작 및 어스용 〈B3〉

ORDER NO.	규격	색상	PRICE, ₩ Ea.	포장단위 Ea. / Cs.
0206-505	50A	적색	590	1 / 500
0256-811	100A	적색	1,210	1 / 300
0206-507	200A	적색	1,390	1 / 100
0256-808	ST-200A(A급)	적색	2,820	1 / 100

Wellz 용접 자석, Arrow Magnetic Welding Holder 다국적

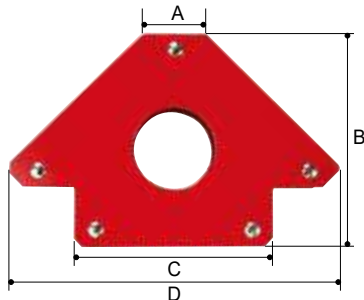

- 용접, 납땜, 조립, 마킹, 파이프 설치, 자화 기능 등 다양한에 사용
- 화살 모양의 디자인으로 다양한 각도로 작업 가능
- 작업 환경시 최적의 자력 : 25, 50, 75LBS



〈B3〉

ORDER NO.	MODEL NO.	PRICE, ₩ Ea.	규격 (INCH)	자력 (LBS)	규격(mm) (A×B×C×D)	포장단위 Ea. / Cs.
0446-687	KMH-03	2,460	3	25	14×83×70×118	1 / 60
0446-688	KMH-04	3,920	4	50	28×102×92×155	1 / 40
0446-689	KMH-05	5,990	5	75	36×121×112×190	1 / 20

Wellz 용접 검사 거울, Telescoping Inspection Mirror 다국적

(1) KIM-02 ▶



(2) LED형 KIM-5283L ▶



- 재질 : 스테인리스
- LED 타입 배터리 : CR2032 2EA



〈B3〉

ORDER NO.	MODEL NO.	PRICE, ₩ Ea.	규격 (mm)	거울직경 (mm)	포장단위 Ea. / Cs.
(1) 0446-701	KIM-02	2,460	1 1/4"×480	-	
0463-753	KIM-50	3,730	185~912	50	1 / 100
0463-755	KIM-82	4,520	276~753	82	
(2) 0463-766	KIM-5283L	5,400	295~885	52×83	1 / 100

Wellz 용접 흑유리, Welding Dark Glass for Face Shield 다국적



- 용접섀드(보호면) 내에 부착. 전기아크용접시 작업자의 시야 보호.
- 규격번호가 커질수록 차광도가 높아짐
- 사이즈 : 105×50(mm), 두께 -3mm

〈B3〉

ORDER NO.	규격(차광도)	PRICE, ₩ Ea.	포장단위 Ea. / Pk.
0335-185	#8		
0335-187	#9		
0296-667	#10	280	1 / 50
0296-668	#11		
0296-669	#12		

Articles

Cat. No

Description

용접케이블, WCT Cable

KOREA



- 적용규격 : KS C IEC 60245-6
- 용접용 홀더선 및 어스용 케이블로 사용
- 외경 : 고무피복 포함, 참조자료만 활용

<B3>

ORDER NO.	규격(SQ)	PRICE, ₩	외경(φ)	중량(kg)	길이(M)
0292-649	16	4,140	10	23	
0292-650	25	6,180	11.5	33	100
0292-651	35	8,230	14	43	

용접 홀더선 세트(어스선+홀더선), Welding Cable Set

KOREA

<B3>

- 완제품 구성으로 아크잭, 어스클램프, 홀더선의 연결작업 없이 바로 사용가능

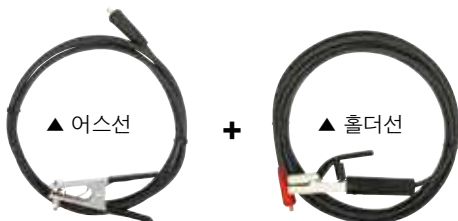

ORDER NO.	규격	PRICE, ₩	어스선 길이(M)	홀더선 길이(M)	아크잭
0479-395	16SQ	57,630	3	7	소형
0479-396	16SQ	77,920	5	10	소형
0483-458		76,050	3	7	소형
0479-398		77,920	3	7	대형
0479-399	25SQ	104,870	5	10	소형
0483-457		106,830	5	10	대형

CO₂ 토치, CO₂ Gas Torch

KOREA

<B3>



- 일반형 CO₂토치
- 손잡이 부분 인체 공학적 설계로 피로도 감소

ORDER NO.	규격	PRICE, ₩ Ea.	길이 (M)	용량 (SQ)	포장단위 Ea. / Cs.
0438-869	350A	86,240	5	30	1 / 5
0438-872	500A	107,800	5	50	1 / 5

CO₂ 팁, CO₂ Gas Tip

KOREA

<B3>

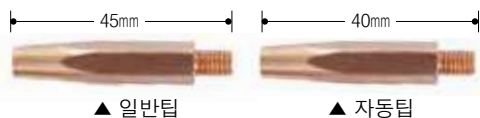

ISO 9001 / ISO 14001

규격 (φ)	일반팁		자동팁		포장단위 Ea. / Pk.
	ORDER NO.	Ea. PRICE, ₩	ORDER NO.	Ea. PRICE, ₩	
0.9	0251-008	560	0413-524	580	1 / 10
1.0	0251-009		0361-707		
1.2	0251-010		0277-035		
1.4	0251-011	0355-162			

CO₂ 가스디피샤, CO₂ Gas Diffuser

KOREA

KOREA

ISO 9001 / ISO 14001

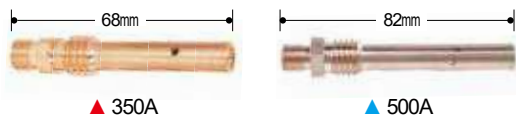

CO₂ 노즐, CO₂ Nozzle

KOREA



<B3>

ORDER NO.	MODEL NO.	PRICE, ₩ Ea.	규격(φ)	포장단위 Ea. / Pk.
▶ 0251-004		840	10	
0251-075	350A	880	11	1 / 10
0251-003		980	12	
▶ 0251-002		1,260	10	
0251-076	500A	1,260	11	1 / 10
0250-974		1,350	12	
0276-550	180A	1,540	분리형	1 / 10
0374-594	F-500	1,090	11	1 / 10

ORDER NO.	품명	PRICE, ₩ Ea.	규격	포장단위 Ea. / Pk.
① 0251-078		1,880	350A-φ 16	
0415-082		1,730	350A-φ 16(등)	
② 0250-997		3,640	500A-φ 19	1 / 20
0406-843	CO ₂ 노즐	4,030	500A-φ 19(등)	
③ 0374-587		3,730	F-500(컷팅)	1 / 10
④ 0374-591		4,290	F-500(테이퍼)	1 / 10
0276-551	CO ₂ 노즐 일체형	3,860	180A(테이퍼)	1 / 10
0251-091		3,890	180A(일자)	1 / 10

Articles Cat. No Description



CO₂ 절연관, CO₂ Insulator

다국적

<B3>



ORDER NO.	MODEL NO.	규격	PRICE, ₩ Ea.	포장단위 Ea. / Pk.
0250-975	350A	φ16/일반	580	1 / 20
▶ 0251-041	350A	φ16/부싱	760	
0251-043	350A	φ17.5/부싱	950	
▶ 0251-044	500A	φ19/부싱	970	1 / 10
▶ 0374-618	F-500	-	4,150	



CO₂ 싱글케이블, CO₂ Single Cable

KOREA

※ 싱글케이블 주문 시 컨넥터 타입 확인이 필요함

<B3>

■ CO₂ 용접기 본체와 송급 장치간 길이를 연장할때 사용



S타입



P타입

ORDER NO.		규격(M)	PRICE, ₩	용량(SQ)
S타입	P타입			
0326-565	0523-688	5	143,580	60
0326-566	0363-654	10	224,430	
0326-567	0523-684	15	304,980	
0326-568	0523-685	20	386,120	
0326-569	-	25	466,480	



송급롤러, Wire Feeder Roller

KOREA

<B3>

■ CO₂ 용접봉의 송급을 도와주는 역할



ISO 9001 / ISO 14001

ORDER NO.	규격(φ × φ)	PRICE, ₩ Ea.	포장단위 Ea. / Pk.
0297-544	0.9 × 1.2	5,300	1 / 10
0374-068	1.0 × 1.0		
0270-149	1.2 × 1.2		
0290-675	1.2 × 1.4		
0326-561	1.2 × 1.6	5,300	1 / 10
0366-266	1.4 × 1.4		



플라즈마 토치세트, Plasma Torch Set

KOREA

ISO 9001 / ISO 14001



① P-80 토치세트



② OTC-30A 토치세트



③ P-80 토치헤드



④ 플라즈마 스위치

■ OTC-30A(M-3000장비용 플라즈마 토치임)
■ 커넥터는 φ25-2P포함

※ 15M이상 별도주문

<B3>

ORDER NO.	품명	PRICE, ₩ Ea.	규격	포장단위 Ea.
① 0250-989	P-80 토치세트	174,440	10M	1
② 0251-227	OTC-30A 토치세트	169,550	10M	1

ORDER NO.	품명	PRICE, ₩ Ea.	규격	포장단위 Ea.
③ 0250-990	P-80 토치헤드	62,040	80A	1
④ 0299-093	플라즈마 스위치	2,270	고무	1



플라즈마 실드 캡/가이드링, Plasma Shield Cap/Guide Ring

다국적

ISO 9001 / ISO 14001



▲ P-80



▲ OTC-30A



▲ 가이드링

<B3>

ORDER NO.	품명	PRICE, ₩ Ea.	규격	포장단위 Ea. / Pk.
0251-223	실드캡(베이크)	1,040	P-80	1 / 10
0251-224	실드캡(세라믹)	950	P-80	1 / 10

ORDER NO.	품명	PRICE, ₩ Ea.	규격	포장단위 Ea. / Pk.
0251-226	실드캡(베이크)	1,150	30A/40A공용	1 / 10
0251-225	실드캡(세라믹)	1,150	30A/40A공용	
0269-034	가이드링	1,140	P-80	

HANTO 프라즈마 노즐/전극, Plasma Nozzle/Electrode

KOREA

ISO 9001 / ISO 14001



① 노즐 (육각) P-80



② 노즐 (접촉식) P-80



③ 전극 P-80



④ 전극 30A

<B3>

ORDER NO.	품명	MODEL NO.	PRICE, ₩ Ea.	규격(φ)	포장단위 Ea. / Pk.
① 0251-235	노즐 (육각)	P-80	1,200	1.3	1 / 10
0251-236				1.5	
0251-237				1.8	
0285-409	노즐 (라운드)	P-80	1,320	1.3	1 / 10
0281-887				1.5	
0282-260				1.8	

ORDER NO.	품명	MODEL NO.	PRICE, ₩ Ea.	규격(φ)	포장단위 Ea. / Pk.
② 0285-407	노즐 (접촉식)	P-80	1,330	1.3(2단)	1 / 10
0285-408		P-80	1,330	1.5(2단)	1 / 10
③ 0251-029	전극	P-80	1,320	-	1 / 10
④ 0250-988	전극	30A	1,320	무도금	

HANTO 알곤토치 (350A) 공냉, TIG Torch Assembly-Air Cooling

KOREA

ISO 9001 / ISO 14001



<B3>

ORDER NO.	규격	PRICE, ₩
0251-058	4M	83,310
0250-979	6M	97,030
0251-059	8M	111,720
0251-060	10M	124,470
0258-359	15M	162,200

HANTO 알곤 콜릿척, TIG Collet Chuck

다국적

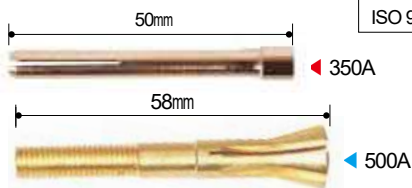

ISO 9001 / ISO 14001

<B3>

ORDER NO.	MODEL NO.	PRICE, ₩ Ea.	규격(φ)	포장단위 Ea. / Pk.
▶ 0250-982	350A	440	1.6	1 / 10
0251-032			2.0	
0251-033			2.4	
0251-034			3.2	
0374-087			4.0	
▶ 0251-035	500A	1,510	2.4	1 / 10
0251-036			3.2	1 / 10

HANTO 알곤 콜릿바디, TIG Collet Body

KOREA

ISO 9001 / ISO 14001

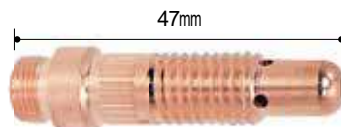

<B3>

ORDER NO.	MODEL NO.	PRICE, ₩ Ea.	규격(φ)	포장단위 Ea. / Pk.
0250-981	350A	900	1.6	1 / 10
0283-892		910	2.0	1 / 10
0251-039		2.4		
0251-040	350A	910	3.2	1 / 10
0374-088			4.0	

Articles Cat. No Description

HANTO **알곤 변형 콜릿척/바디** 다국적
TIG Collet Chuck/Body KOREA
 ISO 9001 / ISO 14001

▲ 변형콜릿척 ▲ 변형콜릿바디

ORDER NO.	품명	PRICE, ₩ Ea.	규격(φ)	포장단위 Ea. / Pk.
▶ 0251-119	350A변형 콜릿척	360	2.4	1 / 10
0251-120			3.2	1 / 10
▶ 0251-121	350A변형 콜릿바디	1,260	2.4	1 / 10
0282-259			3.2	1 / 10

HANTO **알곤 캡, TIG Cap** KOREA
 ISO 9001 / ISO 14001

① 350A 단캡 ② 350A 장캡
 ③ 500A 단캡 ④ 500A 장캡

ORDER NO.	MODEL NO.	PRICE, ₩ Ea.	규격	포장단위 Ea. / Pk.
0250-977		540	단캡	
0291-433	350A	610	중캡	1 / 10
0251-006		630	장캡	
0251-001	500A	1,180	단캡	1 / 10
0250-987		1,230	장캡	1 / 10

HANTO **공냉 알곤토치 헤드 (350A)** KOREA
TIG Torch Head

ORDER NO.	MODEL NO.	PRICE, ₩ Ea.	규격	포장단위 Ea. / Cs.
0251-049	350A	8,540	일반	1 / 10
0251-053	350A	14,710	플렉시블	1 / 10

HANTO **수냉 알곤토치 헤드 (350A)** KOREA
TIG Torch Head

ORDER NO.	MODEL NO.	PRICE, ₩ Ea.	규격	포장단위 Ea. / Cs.
0251-051	350A	9,800	일반	1 / 10
0427-229	350A	22,260	플렉시블	1 / 10

HANTO **알곤 토치헤드 커넥터 (공냉)** KOREA
TIG Nipple (Air Cooling Power Nipple)
 ISO 9001 / ISO 14001

■ 350, 500A 공용

※ 알곤토치헤드 (공냉) 출고 시 알곤토치헤드 커넥터는 포함되어 있지 않음

ORDER NO.	타입	PRICE, ₩ Ea.	포장단위 Ea. / Cs.
0251-158	너트	3,840	1 / 10

HANTO **알곤스위치, TIG Switch** KOREA
 ISO 9001 / ISO 14001

■ 알곤토치 스위치로 사용 ▲ 선부착(15cm)

ORDER NO.	타입	PRICE, ₩ Ea.	포장단위 Ea. / Pk.
0250-978	스위치만	900	1 / 10
0291-477	선부착(15cm)	2,500	1 / 10

HANTO **알곤 세라믹 노즐, TIG Ceramic Nozzle** 다국적
 ISO 9001 / ISO 14001

▲ 350A ▲ 500A ▲ 350A 변형

ORDER NO.	품명	MODEL NO.	규격	PRICE, ₩ Ea.	내경 (φ)	포장단위 Ea. / Pk.
▶ 0250-976			#4		6	
0236-602	알곤 세라믹 노즐	350A	#5	400	8	1 / 10
0236-603			#6		10	
0236-604			#7		11	
▶ 0236-606			#4		6	
0236-607	알곤 세라믹 노즐	500A	#5	620	8	1 / 10
0236-608			#6		10	
0236-610			#7		11	
▶ 0251-139			#4		6	
0251-140	알곤 변형 세라믹 노즐	350A	#5	500	8	1 / 10
0251-136			#6		10	
0251-137			#7		11	

KDY 몽키렌치, Adjustable Wrench

다국적

<B3>



- 크롬 바나듐 합금강 사용
- 벌림쪽을 사용하여 크고 작은 볼트나 너트를 조이거나 풀때 사용

ORDER NO.	MODEL NO.	PRICE, ₩ Ea.	규격	최대벌림 (mm)	포장단위 Ea. / Pk.
0290-854	KAW-200(C)	4,420	200(8")	24~27	1 / 6
0290-855	KAW-250(C)	6,280	250(10")	29~32	1 / 6
0290-856	KAW-300(C)	8,440	300(12")	34~37	1 / 6
0290-857	KAW-380(C)	18,430	380(15")	44~47	1 / 2
0298-886	KAW-450(C)	30,780	450(18")	55~58	1 / 2
0298-887	KAW-600(C)	50,280	600(24")	60~65	1 / 6

KDY 경량몽키렌치, Light Adjustable Wrench

다국적

<B3>



- 기존의 몽키보다 가볍고, 구경이 넓음
- 4가지 컬러 (빨강, 초록, 파랑, 노랑) 랜덤 출고

ORDER NO.	MODEL NO.	PRICE, ₩ Ea.	규격	최대벌림 (mm)	전장 (mm)	포장단위 Ea. / Pk.
0309-464	KLW-150	6,480	150(6")	26	150	1 / 6
0309-465	KLW-200	7,760	200(8")	30	200	1 / 6
0309-466	KLW-250	10,400	250(10")	36	250	1 / 6
0309-467	KLW-300	14,510	300(12")	46	300	1 / 6

KDY 포켓몽키렌치, Stuffy Wrench

다국적

<B3>



- 기존의 몽키보다 가볍고, 구경이 넓음
- 4가지 컬러 (빨강, 초록, 파랑, 노랑) 랜덤 출고

ORDER NO.	MODEL NO.	PRICE, ₩ Ea.	규격	최대벌림 (mm)	전장 (mm)	포장단위 Ea. / Pk.
0309-468	KLW-150S	6,280	150(6")	26	115	1 / 6
0309-469	KLW-200S	7,260	200(8")	30	140	1 / 6
0309-470	KLW-250S	9,800	250(10")	36	155	1 / 6
0309-471	KLW-300S	13,720	300(12")	46	200	1 / 6

KDY 파이프렌치, Pipe Wrench

다국적

<B3>



- 작업물을 물리는 부분이 톱니로 되어 있어 미끄럼 방지

ORDER NO.	MODEL NO.	PRICE, ₩ Ea.	규격	포장단위 Ea. / Pk.
0259-167	KPW-200	4,520	200(8")	1 / 6
0259-168	KPW-250	5,800	250(10")	1 / 6
0259-169	KPW-300	6,770	300(12")	1 / 24
0259-170	KPW-350	8,440	350(14")	1 / 18
0259-171	KPW-450	12,070	450(18")	1 / 8
0259-172	KPW-600	17,560	600(24")	1 / 8
0290-511	KPW-900	34,410	900(36")	1 / 4

KDY 알루미늄 파이프렌치, Aluminium Pipe Wrench

다국적

<B3>



- 최고의 품질과 작업능력
- 미끄럼방지 장치와 특수합금열처리 제품

ORDER NO.	MODEL NO.	PRICE, ₩ Ea.	규격	포장단위 Ea. / Pk.
0259-173	KPW-250(AL)	10,400	250(10")	1 / 6
0259-174	KPW-300(AL)	13,640	300(12")	1 / 6
0259-175	KPW-350(AL)	15,390	350(14")	1 / 6
0259-176	KPW-450(AL)	24,310	450(18")	1 / 8
0259-177	KPW-600(AL)	36,660	600(24")	1 / 8
0287-421	KPW-900(AL)	81,930	900(36")	1 / 4

Articles Cat. No Description

 **핸드소켓 세트, Hand Socket Set** TAIWAN



① 2509MR(9 PCS)



② 3508MR10(8 PCS)

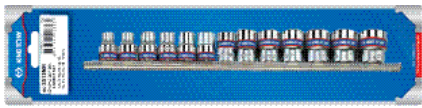

③ 3013MR / 3013SR / 3513MR(13 PCS)



④ 4010MR / 4510MR / 4010SR(8 PCS)

ORDER NO.	MODEL NO.	PRICE, ₩ Ea.	규격	세트 수량	구성	포장단위 Ea. / Cs.
① 0174-442	2509MR	8,730	1/4"	9 PCS	6 2335M	4, 5, 6, 7, 8, 9, 10, 11, 13 1 / 50
② 0277-646	3508MR10	19,540	3/8"	8 PCS	6 3235M	10, 11, 12, 13, 14, 16, 17, 19 1 / 24
③ 0174-562	3013MR	16,080	3/8"	13 PCS	12 3330M	7, 8, 9, 10, 11, 12, 13, 14, 15, 16, 17, 18, 19 1 / 35
0174-564	3013SR	16,080	3/8"	13 PCS	12 3330S	1/4, 5/16, 11/32, 3/8, 7/16, 1 5/32, 1/2, 9/16, 19/32, 5/8, 11/16, 3/4, 13/16 1 / 35
0174-563	3513MR	16,080	3/8"	13 PCS	6 3335M	7, 8, 9, 10, 11, 12, 13, 14, 15, 16, 17, 18, 19 1 / 35
④ 0174-795	4010MR	18,810	1/2"	8 PCS	12 4330M	10, 12, 13, 14, 17, 19, 21, 22 1 / 40
0174-797	4510MR	18,810	1/2"	8 PCS	6 4335M	10, 12, 13, 14, 17, 19, 21, 22 1 / 40
0174-796	4010SR	18,810	1/2"	8 PCS	12 4330S	3/8, 7/16, 1/2, 9/16, 11/16, 3/4, 13/16, 7/8 1 / 40

 **핸드/롱핸드 소켓 세트, Hand Socket & Deep Hand Socket Shelf Set** TAIWAN



ORDER NO.	MODEL NO.	PRICE, ₩	규격	세트 수량	구성	규격별 수량
① 0383-753	3568MR	651,000	3/8"	268 PCS	6 3335M	8, 9, 10, 11, 12, 13 10
						14, 15, 16, 17, 18, 19 8
						21, 22, 23, 24 6
② 0233-199	4572MR	548,110	1/2"	172 PCS	6 3235M	7, 8, 9, 10, 11, 12, 13 10
						14, 15, 16, 17, 18, 19 8
						21, 22, 24 6
② 0233-199	4572MR	548,110	1/2"	172 PCS	6 4335M	8, 9, 10, 11, 12, 13, 14, 15, 16, 17, 18 8
						19, 20, 21, 22, 23, 24, 25 7
						26, 27, 28, 29, 30 6
						32 5

 **A타입 조합렌치, A Type Combination Wrench** 다국적



- 크롬도금 표면처리로 부식방지 ■ 특수 열처리로 내구성 및 강도 우수
- NUT부분이 육각이므로 쉽게 마모되지 않음

ORDER NO.	세트수량	PRICE, ₩ Ea.	구성	포장단위 Ea. / Cs.
0341-231	① 6 PCS	12,850	10, 12, 13, 14, 17, 19	1 / 10
0341-233	② 11 PCS	29,510	8, 10, 11, 12, 13, 14, 16, 17, 19, 22, 24	1 / 10
0341-235	③ 14 PCS	53,620	10, 11, 12, 13, 14, 15, 16, 17, 19, 22, 24, 27, 30, 32	1 / 6



KDY 기어라쳇렌치, Gear Ratchet Wrench

다국적

- 크롬 바나듐 재질
- 뛰어난 제품수명
- 강력한 토크링
- 부식방지 크롬 도금

(1) Standard-type

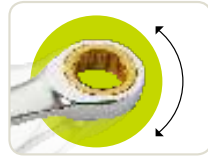

<B3>

ORDER NO.	MODEL NO.	PRICE, ₩ Ea.	규격(mm)	전장(mm)	포장단위 Ea. / Pk.
0282-490	KRG-06	3,340	6	125	
0282-492	KRG-07	3,340	7	132	
0282-493	KRG-08	3,340	8	140	1 / 10
0282-494	KRG-09	3,530	9	150	
0282-495	KRG-10	3,630	10	160	
0282-496	KRG-11	3,730	11	165	
0282-497	KRG-12	3,840	12	170	
0282-498	KRG-13	4,130	13	178	1 / 10
0282-499	KRG-14	4,710	14	190	
0282-500	KRG-15	4,910	15	201	
0282-501	KRG-16	5,100	16	212	1 / 10
0282-502	KRG-17	5,490	17	224	1 / 10
0282-503	KRG-19	5,880	19	248	1 / 10
0282-504	KRG-21	8,150	21	288	1 / 5
0282-505	KRG-22	8,150	22	288	1 / 10
0282-506	KRG-23	8,830	23	320	1 / 10
0282-507	KRG-24	9,410	24	320	1 / 10
0282-508	KRG-27	13,330	27	342	1 / 10
0282-509	KRG-30	15,290	30	365	1 / 10
0282-510	KRG-32	19,210	32	388	1 / 10

KDY 플렉시블 기어라쳇렌치, Flexible Gear Ratchet Wrench

다국적

(2) Flexible

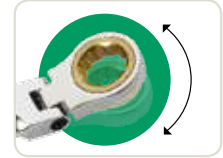

ORDER NO.	MODEL NO.	PRICE, ₩ Ea.	규격(mm)	전장(mm)	포장단위 Ea. / Pk.
0282-523	KRG-06F	4,710	6	125	
0282-524	KRG-07F	4,710	7	132	
0282-525	KRG-08F	4,710	8	140	1 / 10
0282-526	KRG-09F	4,810	9	150	
0282-527	KRG-10F	5,010	10	160	
0282-528	KRG-11F	5,300	11	165	1 / 10
0282-529	KRG-12F	5,590	12	170	1 / 10
0282-531	KRG-13F	5,880	13	178	1 / 5
0282-491	KRG-14F	6,090	14	190	1 / 10
0282-512	KRG-15F	6,280	15	201	1 / 10
0282-513	KRG-16F	6,970	16	212	1 / 10
0282-514	KRG-17F	7,450	17	224	1 / 10
0282-515	KRG-19F	8,150	19	248	1 / 10
0282-516	KRG-21F	9,800	21	288	1 / 5
0282-517	KRG-22F	10,980	22	288	1 / 10
0282-518	KRG-23F	12,650	23	320	1 / 10
0282-519	KRG-24F	13,530	24	320	1 / 10
0282-520	KRG-27F	17,950	27	342	1 / 3
0282-521	KRG-30F	21,080	30	365	1 / 10
0282-522	KRG-32F	27,050	32	388	1 / 10

KDY 라쳇 렌치, Ratchet Wrench

다국적



- 강력한 토크로 최고의 성능 발휘
- 특수 열처리 기어라쳇으로 내구성 우수

<B3>



ORDER NO.	MODEL NO.	PRICE, ₩ Ea.	규격(mm)	전장(mm)	포장단위 Ea. / Pk.
0292-057	KRW 1012	8,540	10×12	235	
0292-058	KRW 1013	8,540	10×13	235	1 / 2
0292-059	KRW 1113	8,540	11×13	235	
0292-060	KRW 1214	8,540	12×14	235	
0292-061	KRW 1317	9,410	13×17	270	1 / 2
0292-062	KRW 1417	8,730	14×17	270	1 / 6
0292-063	KRW 1719	10,400	17×19	312	1 / 6
0292-064	KRW 1721	11,080	17×21	312	
0292-065	KRW 1722	11,080	17×22	312	1 / 2
0292-066	KRW 1921	11,080	19×21	312	

ORDER NO.	MODEL NO.	PRICE, ₩ Ea.	규격(mm)	전장(mm)	포장단위 Ea. / Pk.
0292-067	KRW 1922	11,080	19×22	312	1 / 2
0292-068	KRW 1924	13,330	19×24	355	1 / 2
0292-070	KRW 2126	14,220	21×26	355	
0292-069	KRW 2224	13,330	22×24	355	1 / 2
0292-071	KRW 2427	14,220	24×27	355	
0292-072	KRW 2430	20,690	24×30	395	1 / 2
0292-073	KRW 2632	21,080	26×32	395	1 / 2
0292-074	KRW 2730	21,080	27×30	395	
0292-075	KRW 2732	22,840	27×32	395	1 / 2
0292-076	KRW 3032	22,840	30×32	395	

Articles

Cat. No

Description



함마렌치 / 멩키, Ring Ended Slogging Spanner Wrench

다국적



- ANSI / DIN 규격에 적합
- 재질 : 고탄소강
- HRC : 42 ~ 50
- 복잡한 장소의 정밀작업에 최적

<B3>

ORDER NO.	규격(mm)	PRICE, ₩ Ea.	전장(mm)	포장단위 Ea. / Pk.
0382-100	24	7,550	160	1 / 10
0382-101	27	8,340	180	1 / 10
0382-102	30	9,220	190	1 / 10
0382-099	32	9,610	195	1 / 10
0382-103	34	10,790	195	1 / 10
0382-104	36	11,760	205	1 / 10
0382-105	38	12,750	205	1 / 10
0437-452	40	13,240	225	
0382-106	41	13,720	225	1 / 10
0437-453	42	14,220	225	

ORDER NO.	규격(mm)	PRICE, ₩ Ea.	전장(mm)	포장단위 Ea. / Pk.
0437-454	45	15,200	230	1 / 10
0382-107	46	15,680	240	1 / 6
0437-455	48	17,640	250	1 / 10
0382-108	50	19,600	250	1 / 6
0437-456	52	21,560	260	1 / 10
0382-109	55	23,520	270	1 / 6
0382-110	60	27,440	270	1 / 5
0382-111	65	33,320	290	1 / 2
0382-112	70	41,160	320	1 / 2
0382-113	75	49,000	325	1 / 2



9Pcs 엑스트라 롱볼렌치 세트, Extra Long Ball end Hex L-Key Wrench Set / 9Pcs, 1.5~10mm

TAIWAN

9 PCS (핸들 포함)

(1) Color Coded Type
9Pcs & Handle Set

- 핸들 부착으로 작업시간이 기존렌치보다 4배 단축
- 전 규격 열처리 후 색상 표시
- S2 최고급 합금강 사용(HRC 58~62)
- 테이퍼 헤드(조임 시 렌치를 비트는 힘을 최소화)

구성

- 1.5, 2, 2.5, 3, 4, 5, 6, 8, 10, 핸들

<B3>

ORDER NO.	MODEL NO.	PRICE, ₩ Ea.	세트 수량	포장단위 Ea. / Pk.
0429-792	SBW-9P	23,670	9 PCS	1 / 5

9 PCS

(2) Basic Type
9Pcs Set

- S2 최고급 합금강 사용(HRC 58~62)
- 볼렌치와 육각렌치를 한번에 사용가능

구성

- 1.5, 2, 2.5, 3, 4, 5, 6, 8, 10

ORDER NO.	MODEL NO.	PRICE, ₩ Ea.	세트 수량	포장단위 Ea. / Pk.
0397-980	SBW-9L	12,380	9 PCS	1 / 6



9Pcs 엑스트라 롱볼렌치 세트, Extra Long Ball end Hex L-Key Wrench Set / 9Pcs, 1.5~10mm

GERMANY

9 PCS



구성(mm)

- 1.5, 2, 2.5, 3, 4, 5, 6, 8, 10

<B3>

ORDER NO.	MODEL NO.	PRICE, ₩ Ea.	세트 수량	포장단위 Ea. / Cs.
0369-205	HF-9L	17,160	9 PCS	1 / 10



9Pcs 매직 엑스트라 롱볼렌치 세트, Magic Extra Long Ball Wrench Set / 9Pcs. 1.5~10mm

TAIWAN

9 PCS



○볼트리무버 기능○

폭넓은 삽입각도로 동글거나,
손상된 나사에도 사용가능

- 볼트리무버 기능
- 내부 손상을 최소화
- 0.5mm 범위차가 있어도 사용가능



<B3>

ORDER NO.	MODEL NO.	PRICE, ₩ Ea.	세트 수량	포장단위 Ea. / Cs.
0522-551	SPW-9LC	17,670	9 PCS	1 / 6

SUNKEY 9Pcs 롱볼렌치 세트, Long Ball end Hex L-Key Wrench Set / 9Pcs, 1.5~10mm

TAIWAN

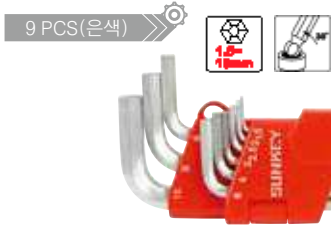

- S2 최고급 합금강 사용(HRC 58~62)
- 볼렌치와 육각렌치를 한번에 사용가능

구성

- 1.5, 2, 2.5, 3, 4, 5, 6, 8, 10

<B3>

ORDER NO.	MODEL NO.	PRICE, ₩ Ea.	세트 수량	포장단위 Ea. / Pk.
0402-936	SBW-9G	9,380	9 PCS	1 / 6

HF 9Pcs 롱볼렌치 세트, Long Ball end Hex L-Key Wrench Set / 9Pcs, 1.5~10mm

GERMANY



구성(mm)

- 1.5, 2, 2.5, 3, 4, 5, 6, 8, 10

<B3>

ORDER NO.	MODEL NO.	PRICE, ₩ Ea.	세트 수량	포장단위 Ea. / Pk.
0369-292	HF-9G	14,030	9 PCS	1 / 10

SUNKEY 9Pcs 쇼트 볼렌치 세트, Short Ball end Hex L-Key Wrench Set / 9Pcs, 1.5~10mm

TAIWAN



- S2 최고급 합금강 사용(HRC 58~62)

- 깊고 좁은 공간에 사용 용이

구성

- 1.5, 2, 2.5, 3, 4, 5, 6, 8, 10

<B3>

ORDER NO.	MODEL NO.	PRICE, ₩ Ea.	세트 수량	포장단위 Ea. / Pk.
0288-448	SBW-9S	7,650	9 PCS	1 / 12

SUNKEY 9Pcs 별 엑스트라 롱렌치 세트, Extra Long Torx L-Key Wrench Set / 9Pcs, T10~T50

TAIWAN



- S2 최고급 합금강 사용(HRC 58~62)

- 케이스가 있어 휴대 간편

구성

- T10, T15, T20, T25, T27, T30, T40, T45, T50

<B3>

ORDER NO.	MODEL NO.	PRICE, ₩ Ea.	세트 수량	포장단위 Ea. / Pk.
0413-861	SSW-9L	16,390	9 PCS	1 / 6

SUNKEY 9Pcs 홀별 엑스트라 롱렌치 세트, Extra Long Tamper Torx L-Key Wrench Set / 9Pcs, T10~T50

TAIWAN



- S2 최고급 합금강 사용(HRC 58~62)

- 자동차 정비 및 기계장비 등에 사용

구성

- T10, T15, T20, T25, T27, T30, T40, T45, T50

<B3>

ORDER NO.	MODEL NO.	PRICE, ₩ Ea.	세트 수량	포장단위 Ea. / Pk.
0434-070	STW-9L	17,670	9 PCS	1 / 6

SUNKEY 9Pcs 6각 L-렌치 링고리세트(휴대용), Hex L-Key Set on Ring / 9Pcs, 1.5~10mm

TAIWAN



- CRV 합금강

- 튼튼한 재질로 내구성이 강함

- 콤팩트한 사이즈로 휴대 간편

구성

- 1.5, 2, 2.5, 3, 4, 5, 6, 8, 10

<B3>

ORDER NO.	MODEL NO.	PRICE, ₩ Ea.	세트 수량	포장단위 Ea. / Pk.
0424-407	SW-9	6,380	9 PCS	1 / 12

Articles

Cat. No

Description

SUNKEY

7Pcs 접이식 육각렌치세트, Hex Fold Out Holder Wrench Set / 7Pcs, 1.5~6mm

TAIWAN



- 휴대 간편
- 크롬 바나듐 재질로 내구성 우수

구성

- 1.5, 2, 2.5, 3, 4, 5, 6

<B3>

ORDER NO.	MODEL NO.	PRICE, ₩ Ea.	세트 수량	포장단위 Ea. / Pk.
0288-454	FHW-7	6,200	7 PCS	1 / 20

SUNKEY

7Pcs 접이식 볼렌치세트, Ball Fold Out Holder Wrench Set / 7Pcs, 1.5~6mm

TAIWAN

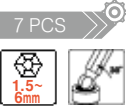

- 한세트에 7가지 규격 탑재
- 열쇠고리가 있어 휴대가 간편

구성

- 1.5, 2, 2.5, 3, 4, 5, 6

<B3>

ORDER NO.	MODEL NO.	PRICE, ₩ Ea.	세트 수량	포장단위 Ea. / Pk.
0288-452	FBW-7	6,660	7 PCS	1 / 20

SUNKEY

7Pcs 접이식 별렌치세트, Torx Fold Out Holder Wrench Set / 7Pcs ; (1) T5~15 and (2) T10~T40

TAIWAN



(1) T5~T15 7Pcs Set



- 휴대 간편
- 크롬 바나듐 재질로 내구성 우수

구성

- T5, T6, T7, T8, T9, T10, T15

<B3>

ORDER NO.	MODEL NO.	PRICE, ₩ Ea.	세트 수량	포장단위 Ea. / Pk.
0288-453	FSW-7	6,930	7 PCS	1 / 20



(2) T10~T40 7Pcs Set



- 휴대 간편
- 크롬 바나듐 재질로 내구성이 우수

구성

- T10, T15, T20, T25, T27, T30, T40

ORDER NO.	MODEL NO.	PRICE, ₩ Ea.	세트 수량	포장단위 Ea. / Pk.
0295-391	FAW-7	7,390	7 PCS	1 / 20

SUNKEY

6Pcs 접이식 렌치세트 (레저용), Fold Out Holder Wrench Assorted Set / 6Pcs ; 4Hex, ⊕ and ⊖

TAIWAN



Good for Leisure Apparatus



- 크롬 바나듐 고강도 재질
- 자전거, 인라인 등의 수리에 용이
- 뛰어난 휴대성

구성

- ● 3, 4, 5, 6, ⊕2, ⊖5

<B3>

ORDER NO.	MODEL NO.	PRICE, ₩ Ea.	세트 수량	포장단위 Ea. / Pk.
0294-609	FDW-6	6,560	6 PCS	1 / 20



7Pcs 접이식 볼렌치 세트, Ball Fold Out Holder Wrench Set / 7Pcs, 2.5~10mm

GERMANY



구성(mm)

- 2.5, 3, 4, 5, 6, 8, 10

<B3>

ORDER NO.	MODEL NO.	PRICE, ₩ Ea.	세트 수량	포장단위 Ea. / Pk.
0457-210	471-170-82	16,080	7 PCS	1 / 10

Articles

Cat. No

Description



연결대, Extension Bar

TAIWAN



전장

<B3>

ORDER NO.	MODEL NO.	PRICE, ₩ Ea.	규격	전장 (mm)	포장단위 Ea. / Pk.
0174-435	2221-04	1,800	1/4"	100	1 / 15
0174-436	2221-06	2,420		150	1 / 15
0174-553	3221-06	2,850	3/8"	150	1 / 6
0174-554	3221-10	3,790		250	1 / 6
0174-784	4251-05	3,890	1/2"	125	1 / 4
0174-785	4251-06	4,100		150	1 / 4
0174-787	4251-10	5,780		250	1 / 4
0174-944	6251-04P	11,140	3/4"	110	1 / 4
0174-945	6251-08P	15,240		200	1 / 2
0174-946	6251-16P	24,890		400	1 / 10



라쳇핸들, Ratchet Handle

TAIWAN



(1) 2769-55P



(2) 4766-10F PUSH 타입

(1) 1/4" & 3/8"

<B3>

ORDER NO.	MODEL NO.	PRICE, ₩ Ea.	규격	기어수	전장(mm)	포장단위 Ea. / Pk.
0174-431	2769-55P	15,760	1/4"	24T	140	1 / 6
0174-548	3769-08P	18,600	3/8"	32T	200	1 / 2

(2) 1/2" & 3/4"

ORDER NO.	MODEL NO.	PRICE, ₩ Ea.	규격	기어수	전장(mm)	포장단위 Ea. / Pk.
0460-510	4766-10F	18,600	1/2"	45T	242	1 / 36
0174-943	6779-20F	65,950	3/4"	24T	500	1 / 6



플렉시블 라쳇핸들, Flexible Ratchet Handle

TAIWAN



▲ 4781-12F

<B3>

ORDER NO.	MODEL NO.	PRICE, ₩ Ea.	규격	기어수	전장(mm)	포장단위 Ea. / Pk.
0504-061	3781-11F	27,310	3/8"	32T	280	1 / 2
0492-153	4781-12F	36,760	1/2"	32T	300	1 / 20



소켓렌치 세트, Socket Wrench Set

TAIWAN



(1) 2526MR / 2526SR (26 PCS)



(2) 5039CR (39 PCS)

1/4"

<B3>

ORDER NO.	MODEL NO.	PRICE, ₩ Ea.	세트 수량 (규격)	구성	포장단위 Ea. / Pk.	
(1) 0174-449	2526MR	48,940	26 PCS	2335M 4, 4.5, 5, 5.5, 6, 7, 8, 9, 10, 11, 13	2779-55G	1 / 18
				2235M 4, 5, 5.5, 6, 7, 8, 9, 10, 11, 13	2221-02 2221-04	
(2) 0174-572	5039CR	59,860	39 PCS (1/4"+3/8")	2335M 4.5, 5, 6, 7, 8, 9, 10, 11, 12	3769-08F	1 / 10
				2335S 3/16, 7/32, 1/4, 9/32, 5/16, 11/32, 3/8, 7/16, 1/2	3221-03	
				3330M 9, 10, 11, 12, 13, 14, 16, 17, 19	3812	
				3330S 3/8, 7/16, 1/2, 9/16, 5/8, 11/16, 3/4	363021	
				2178AE		

Articles	Cat. No	Description					
		Sectional Dressing Tray, with Lid, Seamless, Smooth-contour For Laboratory & Hospital, High-polished, <Korea-made>, 3칸 스텐레스 트레이 * Wide Range Application of Laboratory & Foodstuff * Finished Surface					
		(1) With 3 Diagonal Sections C9.1089 Tray, 3-Section, 230×130×h25mm	<L3> <table border="1"> <tr><th>Ea.</th><th>Price, ₩</th></tr> <tr><td></td><td>16,360</td></tr> </table>	Ea.	Price, ₩		16,360
	Ea.	Price, ₩					
	16,360						
	(2) With 3 Sections C9.1090 Tray, 3-Section, 230×130×h25mm	<table border="1"> <tr><th>Ea.</th><th>Price, ₩</th></tr> <tr><td></td><td>16,360</td></tr> </table>	Ea.	Price, ₩		16,360	
Ea.	Price, ₩						
	16,360						
	(3) With 4 Sections C9.1091 Tray, 4-Section, 220×160×h25mm	<table border="1"> <tr><th>Ea.</th><th>Price, ₩</th></tr> <tr><td></td><td>16,360</td></tr> </table>	Ea.	Price, ₩		16,360	
Ea.	Price, ₩						
	16,360						

 <p>Figure ; Module/Stackable</p>	PP Modular/Utility Container/Tray, with Perforated Wall, White, Stackable, 1.1~4.5Lit Ideal for Drying · Storage · Transfer · &c, -10℃+120℃, 모듈 중첩형 컨테이너/트레이 ■ Made in Korea ■ PP 재질로 내구성이 좋고, 각기 다른 사이즈와 중첩하여 사용 가능 ■ It is Compatibility Stacked with Different Size : Small one on Large one * PP(Polypropylene) ; Good Chemical & Hi-Temp Resistance, Autoclavable * Lightweight for Easy Handling * Feeble Durability	<NEW> <B1>							
	DH.Con3087 Basket Tray, PP, 120×160×h79mm, 1.1Lit DH.Con3088 , 168×242×h79mm, 2.3Lit DH.Con3089 , 241×340×h79mm, 4.5Lit	 <table border="1"> <tr><th>Ea.</th><th>Price, ₩</th></tr> <tr><td></td><td>4,480</td></tr> <tr><td></td><td>5,920</td></tr> <tr><td></td><td>9,180</td></tr> </table>	Ea.	Price, ₩		4,480		5,920	
Ea.	Price, ₩								
	4,480								
	5,920								
	9,180								

	0.5 · 1 · 1.2Lit Silicone Rubber Tray, Durable Construction, Translucent Excellent for Chemical and 220℃ Heat Resistance, Autoclavable, 실리콘 트레이, 단단한 구조 ■ 내열성 & 내화학성이 아주 뛰어난 컨테이너 * Allowable Temperature Limit : 220℃	<NEW> <L2>					
	(1) Low form, without Handle SL.Tra6011 "SB-1" Tray, Silicone, Low form, 500ml , 160×131×h37mm SL.Tra6012 "SB-2" Tray, Silicone, Low form, 1000ml, 216×175×h41mm	<table border="1"> <tr><th>Ea.</th><th>Price, ₩</th></tr> <tr><td></td><td>24,940</td></tr> <tr><td></td><td>39,560</td></tr> </table>	Ea.	Price, ₩		24,940	
Ea.	Price, ₩						
	24,940						
	39,560						
(2) Tall form, with Handle SL.Tra6021 Tray, Silicone, Tall form, 1200ml , 220×110×h70mm	<table border="1"> <tr><th>Ea.</th><th>Price, ₩</th></tr> <tr><td></td><td>39,560</td></tr> </table>	Ea.	Price, ₩		39,560		
Ea.	Price, ₩						
	39,560						



(1) with Dome Cap, 0.2ml



(2) with Flat Cap, 0.2ml

Wisdo² PP 0.2ml PCR Tube, Transparency, Ultra Thin Wall, -196°C + 121°C NEW
 With Domed or Flat Cap, DNase·RNase·Pyrogen- and Endotoxin-Free, 0.2ml PCR 튜브와 캡

- Made in Korea ■ Made of Medical Grade Polypropylene(PP)
- 완벽한 밀폐로 시료의 증발을 방지하고 얇고 부드러운 재질로 열전달이 효율적으로 정확함.
- Ultra Thin-wall Offers High Degree of Transparency, Easy for Observation and Heat Conduction
- * DNase, RNase, and Endotoxin Free. * 500pcs / Inner Pack, 1,000pcs / Outer Case.
- * Soft Opening and Closing / Excellent Sealing.
- * Temperature Range: -196°C (in Gas Phase)+121°C
- * Attached cap allows opening and closing with one hand
- * Universal Fits for the PCR Instrument
- * Domed Caps Ensure Efficient Heat Transfer



<L1>

DH.Tub3101 (1) Tube, PCR, PP, 0.2ml, with Attached Dome Cap
DH.Tub3102 (2) , with Attached Flat Cap

Cs.	Price, ₩
1000ea	39,200
1000ea	39,200

Wisdo² PP 0.2ml PCR 8-Strips Tube, Transparency, Ultra Thin Wall, -196°C + 121°C NEW
 With Domed or Flat Cap, DNase·RNase·Pyrogen- and Endotoxin-free, CE Certified, 0.2ml PCR 스트립 튜브와 캡



PCR 8-Strips Tube



(1) Attached Dome Cap

(2) Attached Flat Cap



(3) with Unattached Flat Cap

- Made in Korea ■ Made of Medical Grade Polypropylene(PP) ■ CE Certified
- 완벽한 밀폐로 시료의 증발을 방지하고 얇고 부드러운 재질로 열전달이 효율적으로 정확함.
- Ultra Thin-wall Offers High Degree of Transparency, Easy for Observation and Heat Conduction
- * DNase, RNase, and Endotoxin Free. * 8-Strip × 12ea / Inner Pack, 10 Inner Pack / Outer Case.
- * Soft Opening and Closing / Excellent Sealing.
- * Temperature Range: -196°C (in Gas Phase)+121°C
- * Universal Fits for the PCR Instrument
- * Can be used with 8-channel Hand-held Micropipettors
- * Tube Strips and Cap Strips can be Cut Easily and used as Individual Tubes
- * Packed in Tamperproof Resealable Bags



<L1>

(1) PP 0.2ml PCR 8-Strips Tube with Attached Dome Cap

DH.Tub3111 Tube, PCR, PP, 0.2ml, with Attached Dome Cap

Pk.	Price, ₩
120ea	56,000

(2) PP 0.2ml PCR 8-Strips Tube with Attached Flat Cap

DH.Tub3115 Tube, PCR, PP, 0.2ml, with Attached Flat Cap

Pk.	Price, ₩
120ea	56,000

(3) PP 0.2ml PCR 8-Strips Tube with Unattached Flat Cap

DH.Tub3116 Tube, PCR, PP, 0.2ml, with Unattached Flat Cap

Pk.	Price, ₩
120ea	72,800

, Plastic-Centrifuge



Biofil[®] PP 0.5 & 1.5ml Screwcap Tube, Sterile, Clear, with Graduation, Conical bottom & Self-standing NEW
 Ideal for Centrifugation and Cryogenic Storage, Leakproof, Autoclavable. 0.5~1.5ml 스크류캡 튜브

- Batch Certifications : Every Case (or Pack) is printed a Lot No. for Quality Traceability
- 100,000 Clean Grade, Manufactured under ISO13485 : 2016 and ISO9001 : 2015 quality management system
- * Autoclavable at 121°C and Freezable to -80°C * Engraved Graduation Ensure Accuracy
- * Screwcap with Silicone O-ring for Leakproof * Screwcap for One-handed Operation
- * DNase/RNase-free and Non-pyrogenic * Sterilized by Gamma Irradiation SAL10⁶ (ISO11137)

<L1>

(1) Conical bottom, 0.5ml & 1.5ml

J1.CFT003.005 Screwcap Tube, Conical, Sterile 0.5ml, φ 11 × h40mm
J1.CFT006.015 , Sterile 1.5ml, φ 11 × h44mm

Pk.	Price, ₩	Cs.	Price, ₩
500ea	59,150	10pk	537,610
500ea	68,870	10pk	625,990

(2) Self-standing, 0.5ml & 1.5ml

J1.CFT005.005 Screwcap Tube, Conical, Sterile 0.5ml, φ 11 × h40mm
J1.CFT008.015 , Sterile 1.5ml, φ 11 × h44mm

Pk.	Price, ₩	Cs.	Price, ₩
500ea	59,150	10pk	537,610
500ea	68,870	10pk	625,990

Articles	Cat. No	Description
----------	---------	-------------



Biofil® 50ml Centrifugal Filter Tube, Conical, Available Pore Size with MWCO 50 and 100KD With PES Membrane, Black Graduation · Frosted Writing Area, 50ml 원심 여과기 튜브 NEW

- **Manufactured in a Class 100,000 Room Environment**
- **Manufactured under ISO13485 : 2016 and ISO9001 : 2015 Quality Management System**
- * Tube : Made of PP(Polypropylene) · Screwcap : Made of HDPE(High Density Polyethylene)
- Filtration : Made of ABS(Acrylonitrile Butadiene Styrene) · Membrane : Made of PES(Polyethersulfone)
- Sealing Gasket : Made of PE(Polyethylene)
- * Ideal for Protein and Nucleic Acid Concentration · Buffer Exchange · Dialysis · Desalting
- * Temperature range : -20°C to 50°C, Non-autoclavable * MWCO : Molecular Weight Cut-Offs
- * Active Membrane area : 5.48 cm² * Typical Final Concentrate Volume: 200µL
- * Maximum RCF : Swinging Bucket Rotor(4,000g), Fixed Angle Rotor(5,000g)

		Pk.	Price, ₩	Cs.	Price, ₩
J1.FTT150.500	Tube, Centrifuge, w/PES Membrane, MWCO 50KD	8ea	66,190	12pk	722,010
J1.FTT100.500	, MWCO 100KD	8ea	66,190	12pk	722,010



Biofil® 225 · 250 · 500ml PP Centrifuge Tube, Conical-type, γ-Sterile, with Moulded Graduation Max RCF up to 7,500xg, RNase-/DNase-free and Non-pyrogenic, Autoclavable, 멸균 / 눈금 원심관

- **Very Popular Centrifuge Tube in Sample Centrifuging and Storage** * 100,000 Grade Clean-room
- * Inner Packing is Individually Labelled for Lot Number to Lot Number Traceability
- * Certified ISO 9001:2008, ISO 13485 * Autoclavable at 121°C and Freezable to -196°C * Leak-proof
- * Tube made with High Quality Gamma Resistant Polypropylene * Plug Seal Cap made with Polyethylene
- * Bottles are Packaged in Durable and Re-sealed Bags with Caps Attached

		Pk.	Price, ₩	Cs.	Price, ₩
J1.T012.225	Tube, Centrifuge, PP, Conical, φ61×h137mm, 225ml	6ea	13,310	8pk	96,780
J1.T012.250	, φ61×h161mm, 250ml New	6ea	15,230	8pk	110,620
J1.T013.500	, φ95×h155mm, 500ml New	6ea	15,460	6pk	84,250



Biofil® 15ml PS Sterile, Centrifuge Tube, Conical Bottom, with Moulded Graduation, 3000xg Ideal for Biological Reaction Experiment, with PE Gasket for Leakproof, PS 멸균 원심관 NEW

- **Manufactured in a Class 100,000 Room Environment**
- **Manufactured under ISO13485:2016 and ISO9001:2015 Quality Management System**
- * Tube : Made of High Quality USP Classic VI Polystyrene(PS) : Glassy-Clear, -10°C +80°C, Non-autoclavable
- Screwcap : Made of HDPE(High Density Polyethylene), -50°C +120°C, Non-autoclavable
- * Non-pyrogenic * Sterilized by Gamma Irradiation SAL10⁻⁶ (ISO11137)

		Ea.	Price, ₩	Pk.	Price, ₩
J1.CFT411.150	Tube, PS, 15ml, φ17×h119.6mm, Re-sealable Bag	25ea	5,800	20pk	105,300
J1.CFT421.150	, Plastic Rack	25ea	6,620	20pk	120,340



Biofil® 15ml PS Graduated Urine Centrifuge Tube, Leakproof, φ 19.6 × 120.5mm, Non-Sterile Ideal for Centrifuging and Storage, Glassy Clear, No-Breakage, Maximum RCF 1500g, 15ml PS 눈금 원심관 NEW

- **Manufactured in a Class 100,000 Room Environment**
- **Manufactured under ISO13485:2016 and ISO9001:2015 Quality Management System**
- * Made of Polystyrene(PS) ; -20°C +70°C, Non-Autoclavable * Meet the Requirements of BSE/TSE and RoHS
- * Colorless and Transparent are Perfect for Biological Reaction Experiments
- * DNase/RNase Free, Latex Free and Non-pyrogenic

		Pk.	Price, ₩	Cs.	Price, ₩
J1.CFT418.150	Tube, Centri., 15/2.5ml, with HDPE Plug Cap, Bulk Pk.	1000ea	160,540		
J1.CFT419.150	, w/o HDPE Plug Cap, Paper Rack Pk.	100ea	16,060	10pk	145,940



250 & 500ml PP Centrifuge Bottles, With PP Screwcap, Autoclavable, -10°C +125/140°C Excellent Chemical Resistance, Translucent, <USA-made>, PP 원심관(병) / 대광구병 NEW

- 내구성, 내약품성 뛰어남 ■ 각사의 로터(히타치 · 쿠보타 · 토미 · 베크 맨 · 코쿠산등)에 적합한 원심병
- **Material : Body/PPCO(Polypropylene Copolymer), Lid/PP(Polypropylene)**
- * Centrifugal Resistance Max.13,200 & 4800 G * Maintain Strength by Refrigerated Centrifuge -10°C
- * Ideal for Large-Volume Cell Harvesting, Pelleting and Protein Purification
- * For Low- to Moderate-Speed Centrifugation of Biological and Chemical Samples

		Ea.	Price, ₩	Pk.	Price, ₩
SL.Bot3871	Centrifuge Bottles, 250ml, φ61.8×125.2mm	110,270		4ea	427,840
SL.Bot3873	, 500ml, φ69.5×170.2mm	121,790		4ea	472,530



Biofil® 14ml PP/PS Culture Tube, Round Bottom, with Moulded Graduation · Dual-position Snap Cap
 Ideal for Biological Reaction Experiment, Leakproof, No-Breakage, PP/PS 컬처 튜브 **NEW**

- **Manufactured in a Class 100,000 Room Environment**
- **Manufactured under ISO13485:2016 and ISO9001:2015 Quality Management System**
- * Tube : 1) Made of Polypropylene(PP) : Clear, Autoclavable at 121℃ and Freezable to -80℃
 2) Made of Polystyrene (PS) : Glassy-Clear, -10℃ +70/80℃, Non-autoclavable
- * Dual-position Snap Cap : Made of LDPE(Low Density Polyethylene)
- * Ribbed Snap Cap for Easy Opening and Closing * DNase/RNase Free, Latex Free and Non-pyrogenic
- * Meet the Requirements of BSE/TSE and RoHS
- * Sterilized by Gamma Irradiation SAL10-6 (ISO11137)

<L1>

(1) PP Round Bottom Tube, $\phi 17.5 \times h95.5$ mm, Autoclavable

- J1. TUB000.140** Tube, PP, 14ml, Non-Sterile, Bulk Pack
- J1. TUB011.140** , Sterile, Rack Pack

Pk.	Price, ₩	Cs.	Price, ₩
50ea	12,490	10pk	113,450
25ea	6,770	20pk	122,900

(2) PS Round Bottom Tube, $\phi 17.5 \times h95.5$ mm, Non-autoclavable

- J1. TUB100.140** Tube, PS, 14ml, Non-Sterile, Bulk Pack
- J1. TUB111.140** , Sterile, Rack Pack

Pk.	Price, ₩	Cs.	Price, ₩
50ea	12,490	10pk	113,450
25ea	6,770	20pk	122,900

Articles	Cat. No	Description
----------	---------	-------------



- **건** : ABS 재질, 건 및 호스 꼬임방지 부착 샤워, 살수, 분사로 용도에 맞춰 사용가능
- **호스** : 내압편사호스로 견고하고 부드러워 겨울철 사용가능, 편사호스는 장력이 좋아 늘어남이 없음(내스내경 ϕ12)
- **수도연결구** : 원터치형, 급수캡이 사용중 분리가 되지 않음

물 호스릴, Water Hose Reel, 20/30/50m

<B3>

ORDER NO.	MODEL NO.	PRICE, ₩	규격
0366-103	MJM-W20	76,940	20M
0366-104	MJM-W30	96,250	30M
0366-062	MJM-W50	115,850	50M

Tubing/Hose Clamps, *Medicaluse* 의료용 튜빙 클램프

※ Hammacher® Premium Maintenance Service for Diamond Coating, Sharpening, Refinishing &c.
⇒ See the “Forceps” Section.

Hammacher® Premium Haemostatic Forceps/Tubing Clamp, Rustproof Stainless-Steel, L120~140mm, *Medicaluse approved* **NEW**
With Serrated Clamp Heads, *Crile · Halsted · Kelly · Kocher · Mosquito*-Forceps, 프리미엄 지혈 겸자 포셉 및 튜빙 클램프 겸용, 독일제 의료용 & 랩 겸용

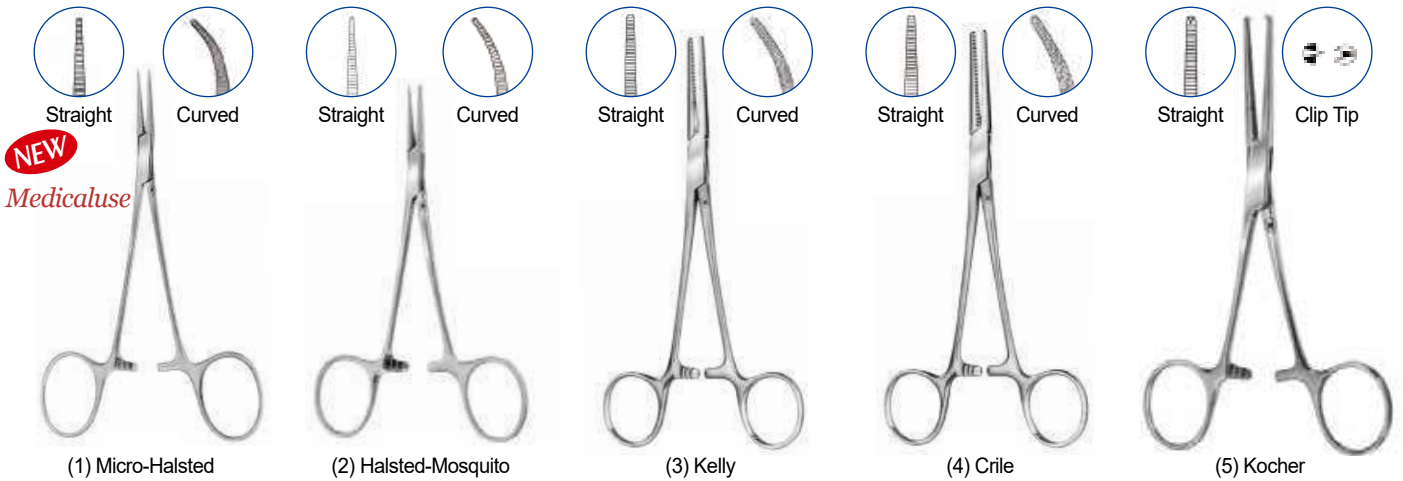

- **Germany-made 프리미엄급; 의료용 지혈 겸자 / 포셉 / 핀셋, 비부식스텐(18/8 크롬·니켈) 제품; 비부식, 내산성 / 내약품성 / 내열성 우수**
- **용도 : 조직이나 혈관을 잡거나 조작, 압박, 절단, 결합, 또는 호스나 튜브를 고정시켜 기밀을 유지하는 등 다목적 기구**
- **격자로 된 홈이 있는 팁이 미끄러지지 않게 잡도록 도와주고, 가위형 손잡이로 간편하게 고정시키거나 잡을 수 있음**
- **Rustproof Stainless-steel of 18/8 Cr-Ni; Rust-proof, Excellent Resistance of Acid / Chemicals / Heat**

(1) Micro-Halsted Forceps, L125mm, 마이크로-할스테드 포셉

* 작은 섬유조직을 잡을 때 유용 * Very Delicate model <M1>

	Ea. Price, ₩
HA.HSE016.12 Forceps, SS, Micro-Halsted, Straight, L125mm	41,520
HA.HSE017.12 , Curved, L125mm	42,890

(3) Kelly Forceps, L140mm, 켈리 포셉

* 비교적 큰 조직을 잡을 때 유용

	Ea. Price, ₩
HA.HSE044.14 Forceps, SS, Kelly, Straight, L140mm	44,880
HA.HSE045.14 , Curved, L140mm	45,820

(5) Tissue Kocher Forceps, with Clip Tip 1:2, L160mm, 코카 포셉

* 비교적 크고 단단한 조직을 잡을 때 유용

	Ea. Price, ₩
HA.HSE088.16 Tissue Forceps, SS, Kocher, Straight, with Clip Tip 1:2, L160mm	54,430

(2) Halsted-Mosquito Forceps, L120mm, 할스테드-모스키토 포셉

* 작은 섬유조직을 잡을 때 유용

	Ea. Price, ₩
HA.HSE022.12 Forceps, SS, Halsted-Mosquito, Straight, L120mm	38,130
HA.HSE023.12 , Curved, L120mm	39,680

(4) Crile Forceps, L140mm, 크리일 포셉

* 비교적 큰 조직을 잡을 때 유용

	Ea. Price, ₩
HA.HSE048.14 Forceps, SS, Crile, Straight, L140mm	44,590
HA.HSE049.14 , Curved, L140mm	45,820

KDY 플라스틱 파이프 커터, Plastic Pipe Cutter, Ex; PP, PTFE, PVC, etc. 다국적



(1) Standard Type, Grip max ϕ 36mm



- 최대벌림 : 36mm
- 테프론 코팅
- 간편 잠금장치
- 알루미늄 바디로 경량화

<B3>

ORDER NO.	MODEL NO.	PRICE, ₩ Ea.	규격(mm)	포장단위 Ea. / Pk.
0477-514	KAP-200	4,710	200	1 / 10

(2) Ratchet Type, Grip max ϕ 42mm



간편 잠금장치

- 최대벌림 : 42mm
- 테프론 코팅 : 물체가 잘 달라붙지 않으며 저항이 적어 빠른 작업 가능
- 원터치 오픈 기능 : 터치 한번에 커터 리로드
- 라쳇 기능 : 세밀한 작업을 위한 라쳇기능
- 간편 잠금장치

ORDER NO.	MODEL NO.	PRICE, ₩ Ea.	규격(mm)	포장단위 Ea. / Pk.
0477-515	KVP-42	9,720	225	1 / 10

PVC 파이프 커터, Ratchet-type Plastic Pipe Cutter

TAIWAN®

(1) 라쳇타입커터, 7913A-63



(1) Cutter



- 피로절감 TPR 핸들
- PVC, PP, PE, PEX, PB 튜브 절단가능

<B3>

ORDER NO.	MODEL NO.	PRICE, ₩ Ea.	사용범위(mm)	포장단위 Ea. / Pk.
0444-897	7913A-63	67,200	6~63	1 / 6

(2) 커터날, 7913A-724



(2) Spare Blade

ORDER NO.	MODEL NO.	PRICE, ₩ Ea.	포장단위 Ea. / Pk.
0457-724	7913A-6311	37,800	1 / 100

Articles	Cat. No	Description
----------	---------	-------------



4W · 6W · 8W Handy UV Lamp, Long & Short Wavelength, <Japan-made>, 자외선 램프, 소형램프 NEW

- 단파장(254nm) & 장파장(365nm) & 듀얼 3가지 타입, 4W & 6W & 8W 튜브
 - Wavelength range : 254, 365nm and Dual Wavelength Combinations.
 - Power range : 4W & 6W & 8W Tubes, Single 4W Tube to Two 8W Tubes.
- * Power Supply : AC100V 50/60Hz

(1) 4W Tubes (Dimensions 201 × 82.3 × h65mm, Filter Size 74 × 47mm)

- SL.Lam7011 UV Lamp, 1 × 4W Tube, 365nm
 SL.Lam7014 , 256nm
 SL.Lam7017 , 1 × 4W / 1 × 4W Tube, 365 / 256nm

<L2>

Ea.	Price, ₩
	361,720
	408,980
	536,220

(2) 6W Tubes (Dimensions 261 × 82.3 × h65mm, Filter Size 154 × 47mm)

- SL.Lam7012 UV Lamp, 1 × 6W Tube, 365nm
 SL.Lam7015 , 256nm
 SL.Lam7018 , 1 × 6W / 1 × 6W Tube, 365 / 256nm

Ea.	Price, ₩
	418,070
	608,930
	754,340

(3) 8W Tubes (Dimensions 336 × 82.3 × h65mm, Filter Size 228 × 47mm)

- SL.Lam7013 UV Lamp, 2 × 8W Tube, 365nm
 SL.Lam7016 , 256nm
 SL.Lam7019 , 1 × 8W / 1 × 8W Tube, 365 / 256nm

Ea.	Price, ₩
	672,550
	763,430
	917,940



2~3ml PS Disposable Blood Sample Cup, for Hitachi® Analyzer, Glassy-Clear, -10°C + 70/80°C Stable
 Ideal for Sample Analysis & Clinical Pathology Testing, CE Certified, 히타치 혈액분석 장비용 샘플 컵

■ 히타치 타입 혈액분석용 샘플 컵 ■ CE Certified * Made of Polystyrene(PS), -10°C+70/80°C, Non-Autoclavable
 * Glassy-Clear * Disposable * with Conical Interior & Self-Standing Bottom

(1) Kartell® Premium-grade, <Italy-made>	<L1>	(2) Wisd. Standard-grade NEW
	Pk. Price, ₩	
KA.2600 Sample Cup, φ 16.75 × h38mm	1000ea 35,080	DH.Cup3101 Sample Cup, φ 16 × h38mm
		500ea 10,440

Articles	Cat. No	Description
----------	---------	-------------

Humasis™ Rapid Quantitative POCT Analyzer “HUBI-QUAN pro”, Portable & Easy Cartridge Reader, *Medicaluse* Immunochromatographic Assay, Enhanced QC, Auto Calibration, Auto Sample-type Recognition, 6 Marker in 15min, <Korea-made> 면역정량분석기



Quantitative POCT Analyzer

Medicaluse

- **적용분야** - 심혈관 검사, 응급검사 : Troponin I, CK-MB, Myoglobin, BNP, Whole blood hCG 검사
- 비뇨기과 검사 : 전립선암 및 전립선비대증 선별검사 (t-PSA, f-PSA), Testosterone
- 산부인과 검사 : LH, FSH, LH/FSH 비율(다낭성난소증후군) 검사
- 이비인후과, 소아과 검사 : 인플루엔자 RSV 검사
- **Simultaneous Diagnosis up to 6 Different Marker in 15min using Whole Blood**
- **Windows, RFID(Radio Frequency Identification) Application : Minimize Error, Easy System Update**
- * 장비 특징점 - 동시 진단 : 한번의 검체 로딩과 한개의 시약으로 최대 6종의 동시 검사 가능
- 소량의 검체 사용 : 100µl~200µl Whole Blood / Plasma / Serum 사용
- 신속한 결과 : 15분 내 최대 6종의 검사 결과 보고
- Android, RFID 시스템 적용 : 자동 캘리브레이션, 결과 보정, 사용간편
- Multi Tray 적용 : 동시 2Test 가능(HUBI-TAS 장비에 한함)
- ※ **Multi Tray 적용 시 Urine stick 측정 가능**
- * Fast Decision in Physician's Office or in Hospital Emergency and Critical Care Settings
- * Wide Range of Diagnosis such as Cardiovascular Disease, Fertility Hormones, Cancer Markers

Specifications & Ordering information

<M4>

Spec.	Model	“HUBI-QUAN pro”
Measured Parameter & Range		HUBI Troponin I : 0.05 ~ 20ng/ml, CK-MB : 1.5 ~ 30ng/ml Myoglobin : 20 ~ 350ng/ml, BNP : 25 ~ 800Pg/ml
Sample-type & Volume		Whole Blood / Plasma, 100 ~ 200uL
Storage Conditions		Operating : 10°C~40°C, 30~75% Humidity Storage : -20°C+60°C, Below 90% Humidity
O/S		Microsoft Window XP Embedded POS Ready
Processor & Memory		AMD PCS 498MHz, 4GB
Display & Printer		4.5° TFT LCD, Thermal Printer; 203 dpi, 2 inch width
Communication Port		USB(2ports), Serial port(RS-232), PS2, LAN
Dimension & Weight		w255 × d178 × h92.7 mm, 1.35kg
Electric Rqts.		100 ~ 240V, 50 ~ 60Hz
Power Adaptor		Medical Power Supply, DC 12V output
Cat. No. & Price ₩		DM.02.1008 ₩ 1,058,750 / Ea

분석항목

검사분류	검사종목	사용검체
Cardiac	Troponin I (Tnl)	Whole blood / Plasma
	CK-MB	
	BNP	
	Cardiac 3-in-1 : Tnl / Myo / CK-MB	
	Cardiac 3-in-1 (B) : Tnl / CK-MB-BNP	
Fertility	Whole blood hCG	Whole blood / Plasma
	Testosterone	Whole blood / Plasma / Serum
	LH	Capillary blood
	FSH	
Tumor	BPHScreen (f- / t-PSA ratio)	Capillary blood / Whole blood / Plasma
	TSH	
	Free T4	
Infectious	Influenza A/ B Ag	Nasal / Throat / Nasopharyngeal swab
	Influenza / RSV	
	COVID-19 Ag	Nasopharyngeal swab
	COVID-19 IgG / IgM	
Others	PCT	Capillary blood / Whole blood / Plasma
	CRP	Whole blood

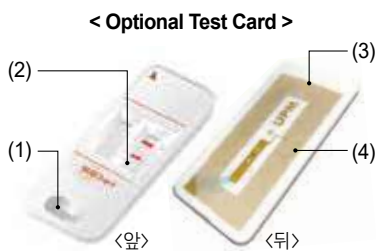

- < Optional Test Card >**
- (1) **Sample Well**
- Blood cells are separated
 - (2) **Assay Area**
- Assay analytes and the reagents are captured on separate
- Area of the device where internal control are located
 - (3) **RFID Chip**
- Communicate with HUBI-QUAN PRO
- Saved Calibration Data
 - (4) **Auto Calibration**
- Data Correction, Sample Identification

Optional Test Card * 좌측 카드이미지 확인

Cat. No.	모델명	검출감도	사용검체	사용기간	Price, ₩
DM.02.1009	HUBI Cardiac 3 in 1	Tnl : 0.05~20 ng/mL CKMB : 15~40 ng/mL Myo : 20~400 ng/mL	Whole blood or Plasm	18 months	453,750
DM.02.1010	HUBI BPHScreen	Total PSA : 0.4~20 ng/mL FreePSA : 0.05~10 ng/mL	Capillary or Venous blood	24 months	132,350

Articles

Cat. No

Description



(1) COVID-19 Ag, 코로나 항원 검사



(2) COVID-19 IgG/IgM, 코로나 항체 검사



(3) COVID-19 홈테스트 자가 검사

Humasis™ COVID-19 Test Kit, Self Diagnosis Through Nasopharyngeal Swab, *Medicaluse*
Available Check within 15 min, <Korea-made>, **코로나19 진단 테스트 키트**

- 식품의약품안전처(MFDS:Ministry of Food and Drug Safety) 내수용 허가 승인 완료
- 감염 초기 환자를 위한 높은 민감도
- 신속, 간편 조작법으로 대단위 검사에 적합
- 코로나 변이바이러스 검출 가능(Biosafety Level 3 시험 입증)
- 독성검사 적합 스왑 포함

* MFDS approved for domestic use * High sensitivity for early stages of infection * 99% accuracy
* 항원 검사 : 체내에 침입한 물질 감염 반응 확인, 항체 검사 : 감염 이후 체내 면역 생성 결과
* 홈테스트 구성품 : 테스트기, 멸균면봉, 추출액 튜브, 필터캡, 사용설명서, 폐기물봉투

(1),(3) 항원 Test, 비인두 검체

(2) 항체 Test, 혈청 검체



Ordering information

<M4>

Cat. No.	모델명	검체	Pk.	Price, ₩
DM.02.1029	(1) COVID-19 Ag Test, 코로나 항원 검사, 전문가용	비인두	25ea	124,790
DM.02.1030	(2) COVID-19 IgG/IgM Test, 코로나 항체 검사, 전문가용	혈청	25ea	124,790
DM.02.1031	(3) COVID-19 Home Test, 항원 자가 검사, 일반용	비인두	2ea	15,000

Humasis™ In-Vitro Diagnostic Testing Kit, Rapid One-step Self Test, Test Kit with Result Display for Sample, *Medicaluse*
For Cardiac Marker · Fertility Hormone · Infectious Disease · Tumor Marker &c., <Korea-made>, **체외진단키트**

Medicaluse



카드형 Cardiac Triple Marker Test Kit

1. Cardiac Marker, 심근경색/심장질환 진단, 카드형

* Acute Myocardial Infarction Test * Based on Immunochromatographic Assay

<M4>

Cat. No.	타입	검출감도	사용검체	사용기간	Pk.	Price, ₩
DM.02.1011	Cardiac Triple Test Plus (TnI/CK-MB/Myoglobin 동시 검사), 심근경색 진단	0.5, 50, 5ng/mL	WB, Serum, Plasma	18개월	10ea	105,880
DM.02.1012	Troponin I, 심장질환 진단	5ng/mL			10ea	52,940

Test Procedure

- Whole blood / Sample / Plasm

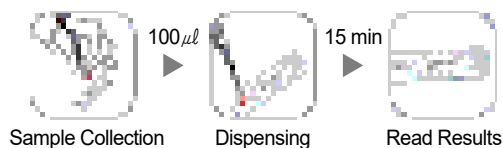

Interpretation of Results

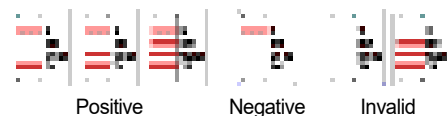

Medicaluse



카드형 스틱형 hCG Pregnancy Test Kit

2. Fertility Hormone, 성 호르몬(hCG/임신, LH/배란) 진단, 카드형 & 스틱형

(1) hCG (human Chorionic Gonadotropin), 임신 진단

* Pregnancy Test

Cat. No.	타입	검출감도	사용검체	사용기간	Pk.	Price, ₩
DM.02.1013	hCG, 카드형	25mIU/mL	Urine	24개월	25ea	20,800
DM.02.1014	hCG, 스틱형				1ea	1,670

Test Procedure

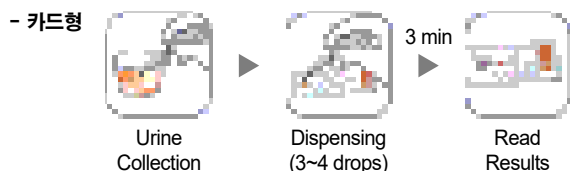

- 스틱형



<Continued On Next Page>

Articles	Cat. No	Description
----------	---------	-------------

<Continued From... Humasis In-Vitro Diagnostic Testing Kit.>

Medicaluse



(2) LH (Lutenizing Hormone), 배란 진단

* Lutenizing Hormon Test

<M4>

Cat. No.	타입	검출감도	사용검체	사용기간	Pk.	Price, ₩
DM.02.1015	LH, 카드형	40mIU/mL	Urine	24개월	25ea	49,160
DM.02.1016	LH, 스틱형				1ea	2,270

Test Procedure

- 카드형

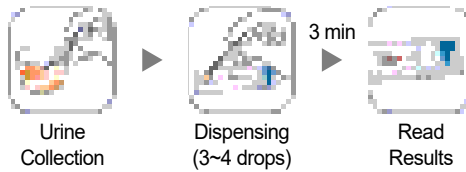

- 스틱형

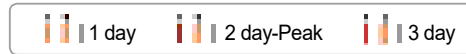
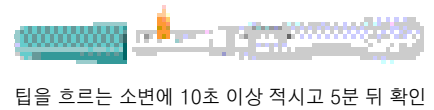

Medicaluse



3. Infectious Disease, 감염성 질환 진단

(1) HBsAg, Anti-HBs, HCV 감염진단, 카드형

* Hepatitis B Virus, Hepatitis C Virus Test

* Based on Immunochromatographic Assay

Cat. No.	타입	검출감도	사용검체	사용기간	Pk.	Price, ₩
DM.02.1017	HBsAg (B형 간염 표면 항원)	1ng/mL	Serum, Plasma	24개월	100ea	34,790
DM.02.1018	Anti-HBs (B형 간염 표면 항체)	30mIU/mL	Serum, Plasma		100ea	34,790
DM.02.1019	HCV (C형 간염 항체)	NA	WB, Serum, Plasma		100ea	136,130

Test Procedure

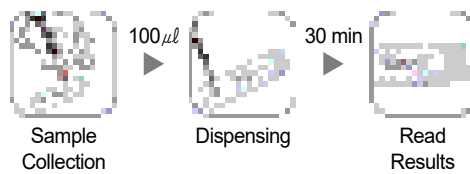

Interpretation of Results

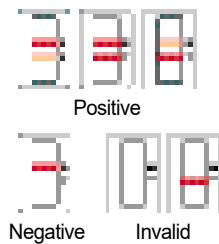

Medicaluse



(2) HIV, Syphilis, Chlamydia 에이즈, 매독, 클라미디아 진단, 카드형

* Based on Immunochromatographic Assay

Cat. No.	타입	검출감도	사용검체	사용기간	Pk.	Price, ₩
DM.02.1020	HIV 1/2 (HIV 1/2 항체), 에이즈 진단	NA	WB, Serum, Plasma	24개월	100ea	136,130
DM.02.1021	Syphilis (시philis 항체), 매독균 진단		Serum, Plasma		100ea	105,880
DM.02.1022	Chlamydia (클라미디아 항원), 클라미디아 진단	2 × 10 ³ IFU/mL	Vaginal Swab	36개월	25ea	94,540

Test Procedure

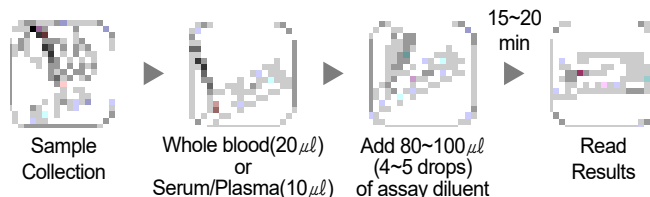

Interpretation of Results

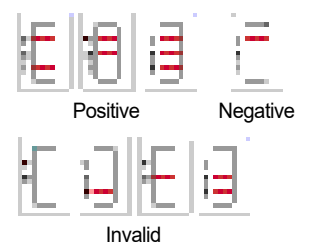

<Continued On Next Page>

<Continued From... Humasis In-Vitro Diagnostic Testing Kit.>

Medicaluse

(3) H.Pylori 헬리코박터 위장 진단, 카드형

* Aid in the Diagnosis of H.Pylori Infection * Based on Immunochromatographic Assay

<M4>



카드형

H.pylori Test Kit

Cat. No.	타입	검출감도	사용검체	사용기간	Pk. Price, ₩
DM.02.1024	H.Pylori	NA	WB, Serum, Plasma	24개월	100ea 128,570

Test Procedure



Interpretation of Results

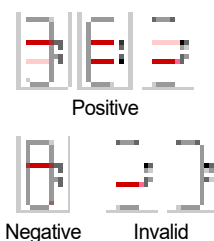

Medicaluse

(4) Influenza A/B Ag 인플루엔자 진단, 스트립형

* Diagnosis of Influenza Infection * Based on Immunochromatographic Assay



스트립형

Influenza A/B Antigen Test Kit

Cat. No.	타입	검출감도	사용검체	사용기간	Pk. Price, ₩
DM.02.1023	Influenza A/B Ag	NA	Nasal, Throat, Nasopharyngeal Swab	24개월	100ea 45,380

Test Procedure

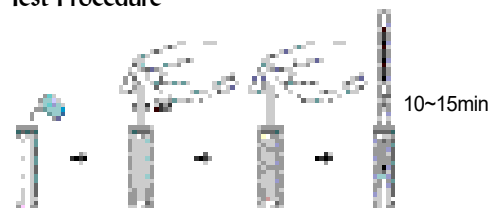

Interpretation of Results

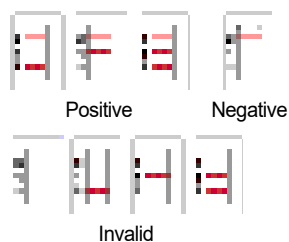

Medicaluse

4. Nicotine Test, 니코틴(흡연) 진단, 카드형

* Test For Nicotine Metabolite in Urine * 효과적인 금연을 위한 측정도구



카드형

Nicotine Test Kit

Cat. No.	타입	검출감도	사용검체	사용기간	Pk. Price, ₩
DM.02.1025	Nico-Find	200ng/mL	Urine	36개월	25ea 51,050

Test Procedure

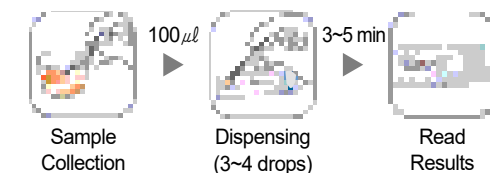

Interpretation of Results

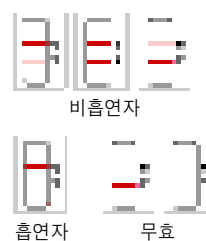

<Continued On Next Page>

Articles	Cat. No	Description
----------	---------	-------------

<Continued From... *Humasis In-Vitro Diagnostic Testing Kit.*>

Medicaluse



5. Tumor Marker, 암 표지자 질환(AFP/간암, PSA/전립선암, FOB/잠혈) 진단, 멀티형

<M4>

Cat. No.	타입	검출감도	사용검체	사용기간	Pk.	Price, ₩
DM.02.1026	AFP (태아 특이성 단백질), 간암 진단	20ng/mL	Serum, Plasma	18개월	100ea	113,440
DM.02.1027	PSA (태아 특이성 단백질), 전립선암 진단	4ng/mL	WB, Serum, Plasma	24개월	100ea	136,130
DM.02.1028	FOB (대변 잠혈), 대장암 진단	50ng/mL	Stool		50ea	55,210

Test Procedure

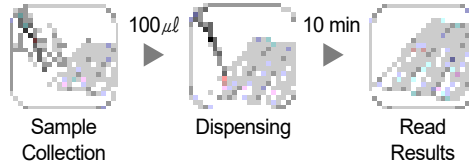

Interpretation of Results

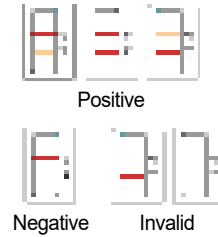

Humasis™ Reagent Strip for Urinalysis “U-AQS11”, for 11 Parameter, Visual or Instrumental Result, *Medicaluse* Dip-and-Read Test Strip, Read at Once in 1~2 min after Dipping, High Accuracy & Reproducibility, <Korea-made>, 뇨 화학시험지

Medicaluse



- **KFDA(식약처) & CE Certified** ■ 소변을 통한 간편한 건강자가진단
- 단백질, 비타민C, 빌리루빈, 백혈구, 아질산, 요비중, 우로빌리노겐, 케톤, 포도당, 혈액, pH검사지
- **Chemistry Test Sheet for Ascorbic acid(Vitamin C), Bilirubin, Blood, Glucose, Ketone, Leukocytes, Nitrate, pH, Protein, Specific Gravity, and Urobilinogen in Urine**
- **Result Provides Information regarding the Status of Carbohydrate Metabolism, Kidney & Liver Function, Acid-Base Balance, Urinary Tract Infection &c.**

* 검사과정 :

1. 시험지를 필요한 매수만 꺼내 즉시 뚜껑을 닫는다 (시험지가 변색되었다면 사용을 금한다.)
2. 용기에 담긴 소변을 사용 전 흔들어 잘 섞어주고 시험지의 시험 부분에 소변을 완전히 적신 후 즉시(1초 내) 꺼낸다.
3. 시험지에 묻어있는 과잉 소변을 준비된 흡수지에 대어 제거한다.

* 주의사항 :

1. 원심분리하지 않은 신선한 소변 사용
2. 채취한 소변을 2시간 이내에 검사
3. 검체 용기는 깨끗하고 건조된 용기 사용

* Fast Results Visually or Instrumentally

* High Accuracy and Reproducibility

* No Interference in Various Conditions

* Good Resistance to Humidity

* Long Shelf Life : 20 months

* Quick Results(All Reagent Pads are Read at One Time, between One and Two minutes after Dipping).

* Unusual Color of Urine can be Reported and Compensated * MFDS(KFDA) Certified & CE Marked

Specifications & Ordering information

<M4>

Spec.	Model	“U-AQS 11”
Kit Type		Dip-and-Read Test Strip
Specimen-type		Urine
Test Time		All Reagent Pads are Read at Once in 1 ~ 2 min after Dipping
Shelf Life		24 month
Storage		Room Temp 2℃ ~ 30℃
Packing Unit		100 Test/Bottle
Cat. No.		DM.02.1032
Price, Each. ₩		18,150

Urinalysis Strips



mediclin® 150ml Urine Collection Specimen Paper Cup, 소변검사용 표본 종이컵, 이중코팅



Back Side, w/ Marking Area

- Made in Korea
- 병의원 진단 검사, 건강검진 등에 사용
- 100% 국내 제작/천연펄프
- 이중코팅으로 새 방지
- * Double Coating to Prevent Leakage

DM.13.1064 Urine Collection Specimen Paper Cup, 150ml, $\phi 70 \times 73$ mm

<M3>

Cs.	Price, ₩
1000ea	23,400

120ml PP Specimen Container, with HDPE Screw Cap, Graduation, Marking Area, $\phi 63 \times h70$ mm
Ideal for Urine, Medical Sample, etc., Sterile & Non-sterile, 샘플 컨테이너, 소변 및 의료용 샘플 검사용, 멸균 & 비멸균



- 의료용 샘플링을 위한 고품질의 시료 용기
- 다용도로 사용이 가능
- 소변, 체액 등의 샘플을 담아서 보관
- * PP : 125/140°C, HDPE : 105/120°C
- * DM.13.1085 : Sterilized by E.O gas

DM.13.1084 Container, 120/10ml, Non-sterile, Bulk Pack
DM.13.1085 , Sterile, 5pcs/Inner Pack

<M4>

dh. Pk.	Price, ₩	Cs.	Price, ₩
20ea	3,820	25pk	63,530
5ea	1,640	50pk	54,450

mediclin® 60 & 120ml All-PP Perfect Sealing Specimen Container, with Screw Cap & Graduation
Ideal for Urine, Medical Sample, etc., Leak-proof, Autoclavable, 눈금부 샘플 컨테이너, 소변 및 의료용 샘플 검사용, 멸균 & 비멸균



(1) 60ml Container



Sterile

- 캡에 씰링 링이 있어서 새지 않고, 표본을 안전하게 보관 가능
- All-PP재질로 오토클레이브가 가능
- 다용도로 사용이 가능
- * Leak-proof * with Marking Area * PP(Polypropylene), -10°C+125/140°C Stable
- * Cap has a Built-in Wedge-shaped Sealing Ring for Perfect Sealing
- * Highly Transparent for Easy Viewing of Samples

(1) 60ml Container, Sterile & Non-Sterile, $\phi 43 \times h55$ mm

* 눈금부에 "ml & oz" 두가지 단위로 표기.

DM.13.1070 Container, 60/10ml, Non-sterile, Bulk Pack
DM.13.1071 , Sterile, Individual Pack

<M1>

dh. Pk.	Price, ₩	Cs.	Price, ₩
20ea	2,840	25pk	102,810
1ea	200	500ea	114,230



(2) 120ml Container

4/pk 멸균포장

(2) 120ml Container, Sterile & Non-Sterile, $\phi 58 \times h72$ mm

DM.13.1090 Container, 120/10ml, Non-sterile, Bulk Pack
DM.13.1091 , Sterile, 4pcs/Inner Pack

dh. Pk.	Price, ₩	Cs.	Price, ₩
20ea	3,150	25pk	72,600
4ea	950	50pk	43,560

mediclin® 120ml Convenient PP Specimen Container & 10ml PET Vacuum Tube, CE Certified, Sterile
Ideal for Urine Collection · Transportation · Storage, 멸균 샘플 컨테이너 & 진공튜브, 소변검사용, 컵과 튜브 개별 구매



(1)

(2)

- 컵 뚜껑에 있는 바늘에 진공 튜브를 꽂으면 컵에 받은 샘플이 진공에 의해 튜브 속으로 빨려 들어감
- 120ml Containers Designed to Use with 10ml Vacuum Tubes
- * CE Certified * Sterilized by E.O gas
- * Good Sealing for Storage & Transportation
- * Highly Transparent for Easy Viewing of Samples

(1) 120ml PP Perfect Sealing Specimen Container Only, Sterile

- * With Needle · Screwcap · Graduation
- * Size : $\phi 50 \times h70$ mm
- * Cap has a Built-in Wedge-shaped Sealing Ring
- * PP(Polypropylene), -10°C+125/140°C Stable

DM.13.1076 Container, PP, Sterile, 120/10ml

<M1>

Pk.	Price, ₩	Cs.	Price, ₩
50ea	15,770	4pk	105,090

(2) 10ml PET Vacuum Tube Only, Sterile

- * With Round Bottom
- * With PP Cap
- * Size : $\phi 13 \times h106$ mm
- * Tube : Made of PET(Polyethylene terephthalate), -40°C+70°C Stable
- * Cap : Made of PP(Polypropylene), -10°C+125/140°C Stable
- * With Marking Area on Label

DM.13.1077 Vacuum Tube, PET, with PP Cap, Sterile, 10ml



100ea / Rack

Pk.	Price, ₩	Cs.	Price, ₩
100ea	17,140	8pk	228,440

※ Usage : Insert Vacuum Tube into Needle on Container Cap to Transport Specimen

Articles	Cat. No	Description
----------	---------	-------------

mediclin® 30 & 60ml Stool/Sample Container, PP & PS, Ideal for Stool, Medical Sample, etc.

With PP Screw Cap & Spoon, 스틸/샘플 컨테이너, 대변 및 의료용 샘플 검사용, 멸균 & 비멸균



(1) 30ml, Non-sterile & Sterile

- 뚜껑에 부착된 분리 가능한 스푼을 이용하여 표본을 옮길 수 있음
- 스푼을 분리하면 일반 컨테이너 용도로 사용이 가능함
- * Sterilized by E.O gas for DM.13.1081 & DM.13.1083
- * PP(Polypropylene), -10℃+125/140℃ Stable
- * PS(Polystyrene), -20℃+50℃ Stable
- * Highly Transparent for Easy Viewing of Samples
- * CE Certified for DM.13.1080 & DM.13.1082 (Non-sterile)



Detachable Spoon

(1) 30ml PS Container, with PP Screwcap & Spoon

* Container; $\phi 24 \times h93mm$ * Spoon; $10 \times 15 \times L71mm$

<M1>

DM.13.1080 Container, 30ml, Non-sterile

DM.13.1081 , Sterile, Individual Pack

Pk.	Price, ₩	Cs.	Price, ₩
50ea	8,570	10pk	102,810
1ea	200	500ea	114,230



(2) 60ml, Non-sterile & Sterile

(2) 60ml All-PP Perfect Sealing Container, with PP Screwcap · Spoon · Graduation

* Autoclavable * with Marking Area & Graduation
* Container; $\phi 43 \times h55mm$ * Spoon; $10 \times 15 \times L49mm$

DM.13.1082 Container, 60/10ml, Non-sterile, Bulk Pack

DM.13.1083 , Sterile, Individual Pack

dh. Pk.	Price, ₩	Cs.	Price, ₩
20ea	3,620	25pk	108,520
1ea	210	500ea	119,940

mediclin® All-PP Black Stool/Sputum Specimen Container, with Screwcap, Spoon, Marking Label, 25ml

Ideal for Stool · Sputum · Medical Sample, etc., <Korea-made>, 채변통 · 객담통 겸용



with Spoon

- 의료 검체의 보관 및 이동에 편리함
- 불투명한 검정색 통으로 내용물이 보이지 않음
- 병의원 진단 검사, 건강검진 등 다용도로 사용 가능
- 스푼이 포함되어 있어 간편하게 표본을 옮길 수 있음
- 정보를 적을 수 있는 라벨이 동봉되어 있어 편리하게 부착하여 사용

* Can be Used for Collecting a Wide Range of Sample of Stool, Sputum, etc.

* Good for Storage and Transport of Medical Samples

* Opaque Black Color * with Spoon

* Includes Adhesive Labels to Write Information

<M1>

DM.13.1065 Container, Black for Stool · Sputum, PP, with Spoon, $\phi 35 \times 50mm$

dh. Pk.	Price, ₩	Cs.	Price, ₩
20ea	3,560	25pk	82,280

mediclin® All-PP Specimen Container, with Screw Cap, Autoclavable, 30ml

Ideal for Sputum, Medical Sample, etc., 125/140℃ Stable, 표본 컨테이너, 객담 및 의료용 샘플 검사용, 멸균 & 비멸균



(1)

- 스crew 캡이 있어 표본을 청결&안전하게 보관

* CE Certified for DM.13.1078 (Non-sterile)

* Sterilized by E.O gas for DM.13.1079

* Highly Transparent for Easy Viewing of Samples

<M1>

DM.13.1078 (1) Container, PP, 30ml, $\phi 49 \times h34mm$, Non-sterile, Bulk Pack

DM.13.1079 (2) , Sterile, Individual Pack

dh. Pk.	Price, ₩	Cs.	Price, ₩
20ea	2,580	50pk	154,200
1ea	160	500ea	88,530



(2)

Sputum Collection PE Container, with Easy to Open Snap Cap, 20ml

Useful for Collect/Storage Samples, <Korea-made>, 객담통



- 객담 채취 및 보관에 용이

■ 라벨 내용 : 성명 · 성별 · 과별 · 연령 · 전화번호 · 병동

* Translucent PE(Polyethylene), -50℃+80/90℃ Stable

<M4>

DM.13.1066 Container, for Sputum, PE, Translucent White, 20ml, $\phi 35 \times 30mm$

dh. Pk.	Price, ₩	Cs.	Price, ₩
20ea	1,270	50pk	65,040

Articles

Cat. No

Description

Medicaluse

CE



One-touch

Moalab® Elastic Tourniquet, with One-touch Buckle, w35 × L490mm, *Medicaluse*
Ideal for Blood Collection, Hemostatic, Re-usable, 원터치 토니켓/지혈대

- Made in Korea ■ CE Certified
- 팔·다리 등 지혈 용도 또는 채혈·정맥주사시 혈관 압박용으로 사용
- 원터치 버클 타입으로 한 손으로 사용이 가능하며 채혈이나 응급 상황에서 지혈에 용이
- * Used for Infusion, Blood Collection, Hemostasis, First Aid
- * Can Stop the Bleeding Quickly Emergency Conditions
- * One-touch Tourniquet; Convenient and Quick to Use, Comfortable * Reusable after Disinfection

DM.13.1051 One Touch Tourniquet, w35 × L490mm, Blue

<M4>

Ea.	Price, ₩
	7,570

Medicaluse

CE



5 Depth Control

LANZO® Adjustable Lancing Device for Blood Testing, 5 Depth Control, *Medicaluse*
Works with Lancets, Ideal for Blood Test, Avoid Infection, Safety, φ 16 × L106mm, 채혈기/사혈기

- Made in Korea ■ CE Marked
- 소량의 채혈 및 사혈을 위해 전용 침(라셋)을 넣어 사용하는 기구, 침 깊이 5단 조절
- * Specially Designed for the Highest Comfort in Daily Diabetes Management
- * Adjustable 5 depth Tip Settings for Personalized Comfort * Painless and Hygienic

DM.13.1057 Medical Blood Lancing Device, for Blood Test, φ 16 × L106mm

<M4>

Ea.	Price, ₩
	3,030

Medicaluse



Safety Sterile Lancet, with Safety Removable Twist Top, Blood Collection, Single Use, *Medicaluse*
3mm Depth Needle, Gauge 26G · 28G · 30G, 일회용 멸균 채혈침

- Made in Korea ■ 소량의 채혈 및 사혈을 위한 수동식 멸균침 ■ 안전한 트위스트형 보호캡
- * Designed for Comfortable, Easy Monitoring Your Daily Health.

DM.13.1052 Safety Lancet, d3mm Needle, 26G
DM.13.1053 , 28G
DM.13.1054 , 30G

<M4>

Pk.	Price, ₩	Cs.	Price, ₩
200ea	2,880	100pk	288,000
200ea	2,880	100pk	288,000
200ea	2,880	100pk	288,000

Medicaluse



Regular

Triangular

* Sterile

Moalab® Sterile PAP Smear Brush, Easy Grip PP Handle, φ 6 & φ 13mm, L195mm, *Medicaluse*
Suitable for Collect Sample, Individual Package, <Korea-made>, 자궁경부암 검사 샘플채취용 멸균 브러쉬 2종

- 닿기힘튼 샘플채취 사용가능 ■ 자궁경부 부위의 질세포나 점액채취에 용이 ■ EO Sterile

DM.13.1055 Sampler PAP Brush, Sterile, PVC-hair, Regular Brush, φ 6 × L195mm (Handle 175mm)
DM.13.1056 , Triangular Brush, φ 13 × L195mm (Handle 175mm)

<M4>

Pk.	Price, ₩	Cs.	Price, ₩
100ea	36,300		
100ea	39,930		



Tamper Evident Sticker

mediclin® Sterile Transport Swab Tube, Ideal for Specimen Collection, Cotton & Viscose-Tip
Disposable, Individual package, 샘플채취용 스왑, 비스코스 & 면봉, 멸균개별포장

- * The Multiplication of the Bacteria is Prevented. * with Tamper Evident Sticker
- * Sterilized and Individual Packaged with Transport PP Tube, φ 13 × 173mm
- * Material : DM.13.1086 - Tip : Cotton, Stick : Wooden
DM.13.1087 - Tip : Viscose, Stick : Snappable PS

DM.13.1086 Swab, Tip - φ 5.0 × 14mm, Handle - φ 3.0 × 120mm
DM.13.1087 , Tip - φ 5.0 × 16mm, Handle - φ 2.0 × 122mm

<M1>

Pk.	Price, ₩	Cs.	Price, ₩
1ea	560	2000ea	558,400
1ea	560	2000ea	558,400



PE Disposable Serum Separating Tube, 10ml, 혈청분리관

- Made in Korea * Made of PE(Polyethylene), -50°C + 80/90°C Stable
- * For Sampling and Storage of Clinical Specimen

DM.13.1067 Serum Separating Tube, 10ml, Stem : φ 3 × L100mm, Tube : φ 13 × L120mm

<M4>

Pk.	Price, ₩
200ea	11,050

Medicaluse



12ml Urine Specimen & Centrifuge Tube, Conical Bottom & Internal Graduations, *Medicaluse*
Disposable, Made of PVC(Polyvinyl Chloride), -20°C + 80°C Stable, <Korea-made>, 소변 채취용 뇨원심관

- 소변 검사시 사용되는 원심관 ■ Ideal for Sample Analysis

DM.13.1058 Specimen & Centrifuge Tube, PVC, 12ml, φ 17 × h108mm

<M4>

Pk.	Price, ₩
200ea	10,890

Articles	Cat. No	Description
----------	---------	-------------

Humasis™ Reagent Strip for Urinalysis “U-AQS11”, for 11 Parameter, Visual or Instrumental Result, *Medicaluse*
 Dip-and-Read Test Strip, Read at Once in 1~2 min after Dipping, High Accuracy & Reproducibility, <Korea-made>, **뇨 화학시험지**

Medicaluse

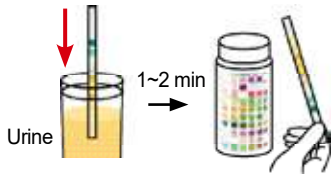

뇨 화학시험지 사용방법

- **KFDA(식약처) & CE Certified** ■ **소변을 통한 간편한 건강자가진단**
- **단백질, 비타민C, 빌리루빈, 백혈구, 아질산, 요비중, 우로빌리노겐, 케톤, 포도당, 혈액, pH검사지**
- **Chemistry Test Sheet for Ascorbic acid(Vitamin C), Bilirubin, Blood, Glucose, Ketone, Leukocytes, Nitrate, pH, Protein, Specific Gravity, and Urobilinogen in Urine**
- **Result Provides Information regarding the Status of Carbohydrate Metabolism, Kidney & Liver Function, Acid-Base Balance, Urinary Tract Infection &c.**

* 검사과정 :

1. 시험지를 필요한 매수만 꺼내 즉시 뚜껑을 닫는다 (시험지가 변색되었다면 사용을 금한다.)
2. 용기에 담긴 소변을 사용 전 흔들어 잘 섞어주고 시험지의 시험 부분에 소변을 완전히 적신 후 즉시(1초 내) 꺼낸다.
3. 시험지에 묻어있는 과잉 소변을 준비된 흡수지에 대어 제거한다.

* 주의사항 :

1. 원심분리하지 않은 신선한 소변 사용
2. 채취한 소변을 2시간 이내에 검사
3. 검체 용기는 깨끗하고 건조된 용기 사용

- * **Fast Results Visually or Instrumentally** * **High Accuracy and Reproducibility**
- * **No Interference in Various Conditions** * **Good Resistance to Humidity** * **Long Shelf Life : 20 months**
- * **Quick Results(All Reagent Pads are Read at One Time, between One and Two minutes after Dipping).**
- * **Unusual Color of Urine can be Reported and Compensated** * **MFDS(KFDA) Certified & CE Marked**

Specifications & Ordering information

<M4>

Spec.	Model	"U-AQS 11"
Kit Type		Dip-and-Read Test Strip
Specimen-type		Urine
Test Time		All Reagent Pads are Read at Once in 1 ~ 2 min after Dipping
Shelf Life		24 month
Storage		Room Temp 2℃ ~ 30℃
Packing Unit		100 Test/Bottle
Cat. No.		DM.02.1032
Price, Each. ₩		18,150

Urinalysis Strips

